

The MAVERICK Collection



MAVERICK | SERIES



MAVERICK COMPLETE | SERIES



VISTA | SERIES



CANYON | SERIES



TRAINING | SERIES



CONFERENCE | SERIES



APEX | SERIES

MAVERICK

OFFICE SOLUTIONS | MADE IN THE U.S.A.



Maverick	4-54
Maverick Complete	55-106
Vista	107-124
Canyon	125-138
Conference	139-148
Training	149-155
Apex	156-188
Warranty	189

LOOK FOR THESE ICONS



Maverick Series furniture that is available on our 72-hour QuickShip program is annotated with this symbol . When you need it fast, find it fast! Order size limits may apply. See the symbols above throughout the catalog for delivery times.

The American flag denotes Series that are available through our GSA program.

This catalog is divided into sections to help you quickly find the furniture and equipment that fits your needs.

If you don't find what you need, please call us. All prices in this catalog are suggested manufacturer's retail prices.

WHY MAVERICK...FEATURES & BENEFITS

- Made in the U.S.A.
- 10 Year Limited Manufacturer's Warranty
- Meets California Air Resource Board – Airborne Toxic Control Measures to Reduce Formaldehyde Emissions
- GSA Approved
- 18 Standard Colors
- Mix and Match Colors at N/C
- Tops and Chassis are 1" Durable Thermally Fused Melamine on 45lb. Industrial Strength Particle Board
- 2-mm Thermally Fused PVC Edge banding
- Metal to Metal connection fittings are installed for bridges and returns
- All products are shipped set-up
- Chassis fastened by screws, steel brackets and/or concealed fasteners
- Adjustable leveling glides
- 9-Ply Birch Wood Lacquer Finish Drawer Interiors
- All Drawers are Standard with 125lb. full-extension, progressive- action slides with precision steel ball bearings
- All Lateral Files Standard with 150lb. Override full-extension, progressive-action with steel ball bearings
- Letter or Legal Filing on all file and lateral file drawers
- Metal to Metal inserts on all drawers for easy replacement
- Optional Locks, Grommets, and Handles
- Master keys and keyed-alike combinations are available
- Custom colors, sizes and configurations available
- 72-Hour Quick Ship

Visit
MaverickDesk.com
for the latest information on products



Download
GIZA Maverick East Library



Download
CAP Maverick East Library

Prices and product specifications are subject to change without notice.

Conform vs. Perform

mav • er • ick: (adjective)

being independent in thought and action
or exhibiting such independence

Chances are you've gotten where you are today by blazing your own trail and creating a personal stamp of excellence along the way. That same spirit of independence and individuality is embodied in the Maverick Collection. Interchangeable styles and "room- to-grow" designs are just a few qualities that set us apart from the herd.



Well Beyond the Ordinary

Complete flexibility for every working environment, from private to open spaces, reception areas to team stations or the big corner office.

You've Made the Right Choice

A perfect balance of performance, appearance and budget-stretching value. Maverick is backed by a solid reputation and superior customer service.

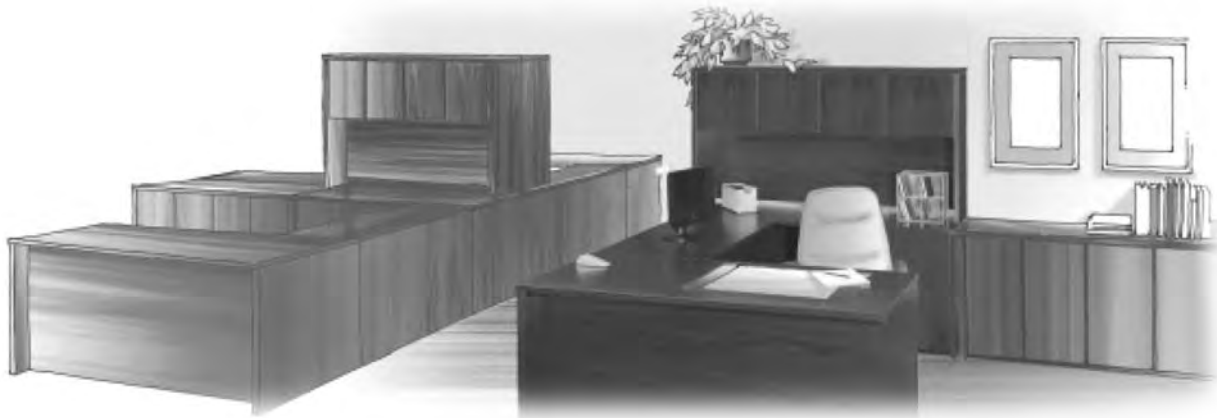

Function meets Style - The Maverick Solution

At Maverick it's just not enough to make a product that serves a function. It needs to be a reflection of the client it serves. Today space is at a premium. The furniture you use must not only serve as a functional asset in the space it occupies but also reflect the personality of your business.

The Maverick Solution is the concept of function meeting style. The Maverick Solution allows you to pick from hundreds of functional components then select from 18 different colors, multiple sizes and varied stylings to best suit your business environment. Speed, service and selection - the keys to your success with the Maverick Solution.



Maverick Series

Modern, clean-cut, contemporary styling. A full line of stand-alone casegoods and accessories for executive, team and panel-wrapped contract office settings. Our most popular and most complete series.

Product Specifications

Colors

- All 18 standard colors are available on tops and chassis

Tops/Worksurfaces

- 1" TFM (Thermally Fused Melamine) on industrial quality (45 lb.) particleboard
- 2 mm thermally-fused PVC edge banding
- Conference table tops present a 1 3/4" built-up edge
- Metal-to-metal connection fittings are installed for bridges and returns
- Woodgrain direction on tops of bridges and returns runs from user side to approach side to coordinate with main unit tops



Configuration MM 4 shown above.

Chassis Construction

- TFM chassis fastened by screws, steel brackets, and/or concealed fasteners
- 3/4" pedestal is standard; full pedestal is optional; double-wall pedestal housing construction
- 1"-thick end panels on desks, returns, credenzas, and bookcases. 3/4" thick end panels on hutches
- 3/4" height modesty panel on 3/4" pedestal unit is standard; 12" modesty may be specified at no upcharge on bridges and returns
- Full-height modesty panel on full pedestal units such as lateral file returns is standard
- Bullet desks are standard with 3/4" modesty panel and have 4" black metal posts
- Conference tables are provided with 7" modesty panel
- Unless otherwise specified, conference and round table bases are the same color as the top. Contrasting colors may be specified at no charge
- The modesty inset on the approach side for 30"-deep tops is 6"; for 36"-deep tops, inset is 12"
- The modesty panel is flush to the approach edge on 20"-and 24"-deep tops
- Visible edges are edged with 2 mm thermally-fused PVC edge banding
- Adjustable leveling glides are provided on all units that are designed to be set on the floor
- Hutches for Maverick Series are designed to fit Maverick Series ONLY. Shipped with nail glides on legs - remove for installation
- Product heights are coordinated to facilitate matching, e.g., credenza plus hutch is 65" high. Optional 72" height is available, see page 42
- Standard woodgrain direction on the modesty of pieces 60" wide or less is vertical. On pieces wider than 60", the grain direction is horizontal
- Lateral file and vertical file chassis are all 3/4" material

Drawer Interiors

- 9-ply Birch wood drawers

Drawer Suspension, Construction and Doors

- Box drawers have full-extension, progressive-action slides with precision steel ball bearings.
- Heavy-duty file rods in file drawers
- Drawer fronts are inset to end panels except on storage units
- Recessed finger pulls are provided. Handles are an accessory option, see page 50
- Storage and file units only have MM H3B handles standard
- Overlay drawer front and doors are standard on all separate storage units and separate file units. Other furniture with storage and lateral file elements are inset to the end panels of chassis and overlay at the kneespace
- All file and lateral drawers file legal-size from side-to-side
- Each desk only is provided with one box drawer convenience tray. See page 51 for optional additional trays for other units
- File drawer construction accommodates hanging files not stacked material on drawer bottom
- Hutch doors overlay sides before inset to top with 19" clearance below

Cord Management

- A grommet is standard on computer corner elements and reception units; 3/4" clearance at bottom of hutch backs
- Optional wire management is available - grommets on page 43

Locks

- Optional except on vertical and lateral files only; on the personal lateral file, the box drawers do not lock
- Optional locking on all pedestals, wall-mount cabinets, hinged-door storage units and hutches is available, see page 43 & 50
- Black or silver, removable cores are standard for all locks
- Pedestal key numbers are randomly assigned to all locking pedestals, except that double pedestal units will be keyed alike
- Master keys and keyed-alike combinations are available

Note: Dimensions assigned in this price list are nominal. If exact measurements are required, the requirement must be specified in the order and specifically acknowledged by Maverick. Maverick reserves the right to change construction details and standards without notification, if necessary.

Maverick Series

How to Order Maverick Series

WORKSURFACE UNITS: DESKS, CREDENZAS AND RETURNS

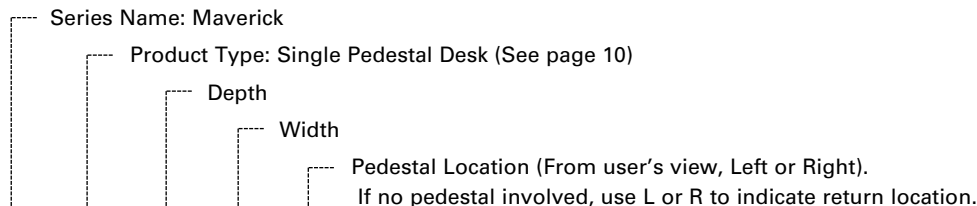

1. Product number: **MM S 36 72 L**
2. Specify Worksurface Finish. See back cover.
3. Specify Worksurface Edge Banding Finish. Matching color edge banding is standard. See back cover.
4. Specify Chassis Finish. Matching color edge banding is standard. See back cover.
5. Specify Handle Upgrade Options. H3B is standard on storage and lateral file units only. See below and page 50.
6. Specify Other Accessories or Upgrades. See below and pages 50-54.

HANDLE UPGRADE OPTIONS:

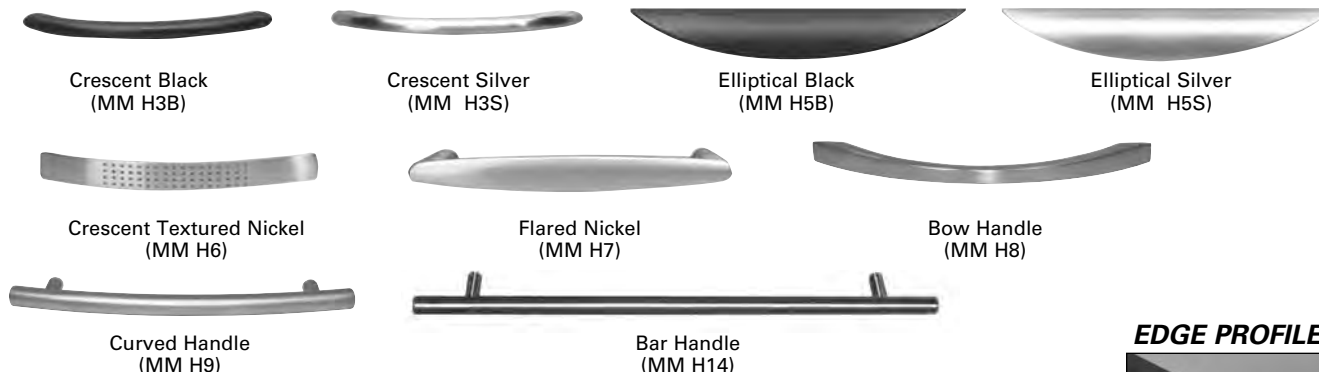

IMPORTANT NOTE: H3B handle is standard only on Maverick Series storage units and lateral files (except sliding door credenzas). See page 50 for prices. H3, H5 thru H14 are \$25 each, H30...\$52 each.

EDGE PROFILE:



2 mm flat PVC edge banding on tops

SIDE VIEW:



OTHER OPTIONS/UPGRADES:

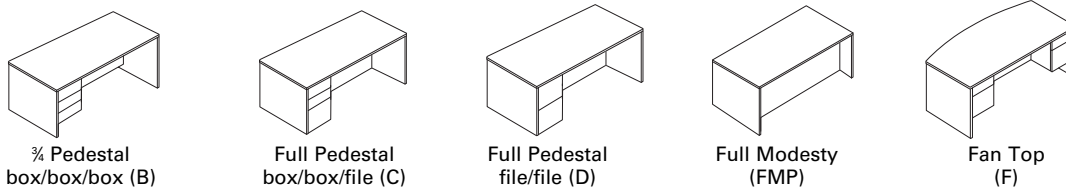

GROMMET
 Black grommet standard. Upgrade to silver color, N/C.

GROMMETS (WORKSURFACE)

Note: While sitting at unit, grommet locations named from left to right. For grommet location on tops and/or modesty panel specify left, center or right. **No grommets over pedestals.**

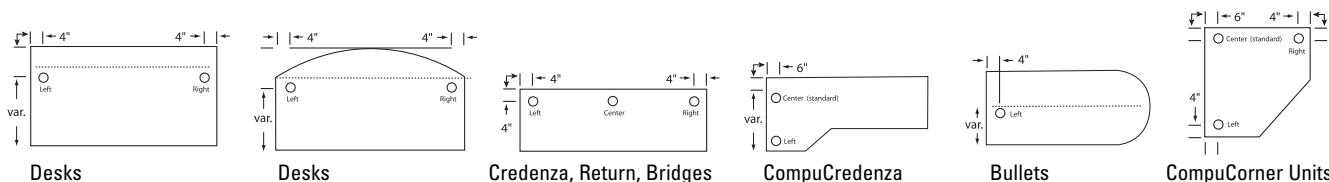

Maverick Series



Statement of Line

DESKS:

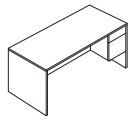

Desk - single pedestal (S)

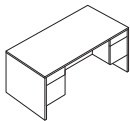

Desk - double pedestal (D)

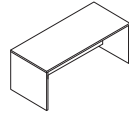

Desk - shell (N)

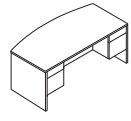

Desk Fan Top - dbl. ped. (FD)

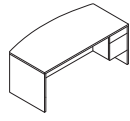

Desk Fan Top - sgl. ped. (FS)

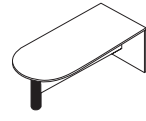

Bullet Desk - standard (BD)

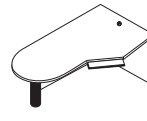

Bullet Computer Desk (BDC)

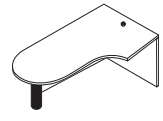

Bullet Computer Desk Curved (BDCQ)

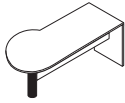

Desk - P-shape (PBD)

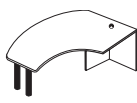

Wedge (BWQ)

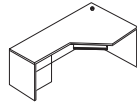

Comp. Desk - sgl. ped. (CD72 9)(Front Unit)

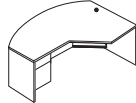

Fan Top Comp. Desk - sgl. ped. (FCD72 9)(Front Unit)

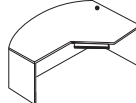

Fan Top Comp. Desk - shell (FCDN72 9)

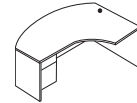

Fan Top Comp. Desk Curved - sgl. ped. (FCDQ72 9)

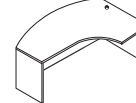

Fan Top Comp. Desk Curved - shell (FCDNQ72 9)

CRENZAS:

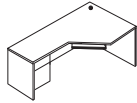

CompuCorner - sgl. ped. (CD)

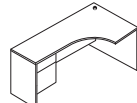

CompuCorner Curved - sgl. ped. (CDQ)

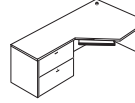

CompuCorner - 31" lateral (CDLF)

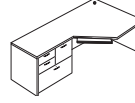

CompuCorner - 31" pers. lat. file (CDPLF)

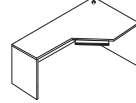

CompuCorner - shell (CDN)

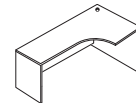

CompuCorner - curved shell (CDNQ)

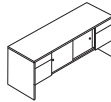

Credenza - dbl. ped. & storage (C_2)

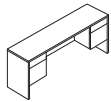

Credenza - dbl. ped. (kneespace) (C_3)

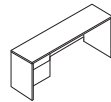

Credenza - sgl. ped. (C_4)

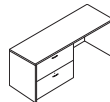

Credenza - lat. file (C_5)

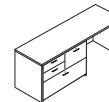

Credenza - pers. lat. file (C_6)

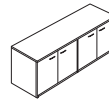

Credenza - full storage (C_1FP)

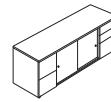

Credenza - 2 full ped./storage (C_2FP)

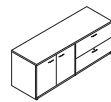

Credenza - Storage File (C_9FP)

RETURNS:

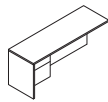

Return - 3/4 ped. (RA)

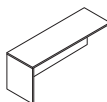

Return - shell (RN)

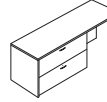

Return - lat. file (RLF)

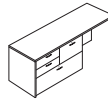

Return - Pers. Lat. File (RPLF)

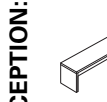

Bridge - reception (RB)

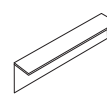

Bridge - reception return (RBR)

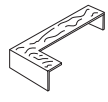

Bridge - reception L (RBL)

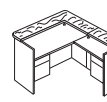

Reception - "L" (RCAL)

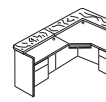

Reception - computer (RCOL)



Reception - front (RCAD)

RECEPTION:

BRIDGE:



Bridge (BR)

HUTCHES:

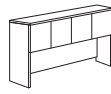

Hutch - with doors (H_WD)

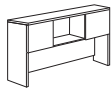

Hutch - 2 door (H_W2D)

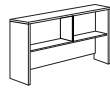

Hutch - no doors (H_ND)



Hutch - bookcase (BCH)

BOOKCASES:

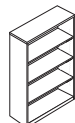

Bookcase (BC)

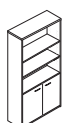

Bookcase - storage (BCD)

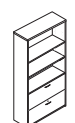

Bookcase - lateral (BCLF)

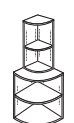

Bookcase - corner (BCC)

FILING:

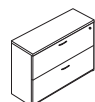

Lateral File (LF2)



Lateral File - 3-draw (LF3)



Lateral File - 4-draw (LF4)

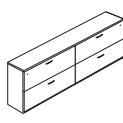

Lateral File - double (LF_2+2)

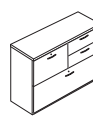

Lateral File - personal (PLF)

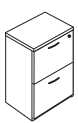

Vertical File (VF)

CONFERENCE:

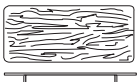

Conference Table - rectangular (RE)



Conference Table - boatshape (BS)

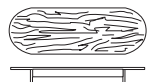

Conference Table - racetrack (RT)



Table - round (RD)

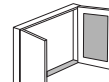

Conference board (CB)



Lectern (LT)

STORAGE:



Cabinet - single (STS)

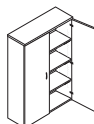

Cabinet - double (ST)

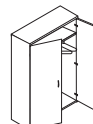

Cabinet - wardrobe (WC)

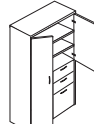

Personal Storage Unit (WCP)

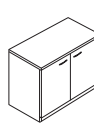

Cabinet - utility (HDC)

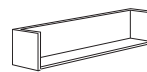

Cabinet - overhead (CFOHA)

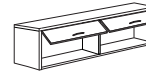

Cabinet - overhead (CFOHB)

STANDS:



Printer Stand (PS)

PEDESTALS:



Mobile - box/box/file (PEDCX)

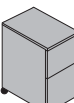

Mobile - file/file (PEDDX)



Mobile - Pencil/Box/file (PEDEX)



Maverick Series

Configurations - All are available on

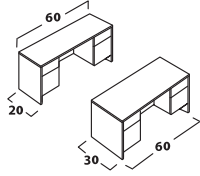

- MM1**
 1 MMD3060 \$946
 1 MMC2060 3 \$931
\$1,877

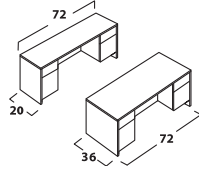

- MM2**
 1 MMD3672 \$1,178
 1 MMC2072 3 \$1,146
\$2,324

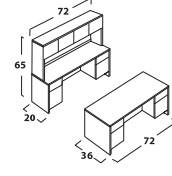

- MM3**
 1 MMD3672 \$1,178
 1 MMC2072 3 \$1,146
 1 MMH72WD \$1,125
\$3,449

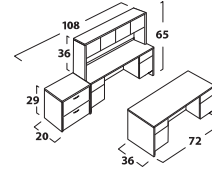

- MM4**
 1 MMD3672 \$1,178
 1 MMC2072 3 \$1,146
 1 MMH72WD \$1,125
 1 MMLF202 \$856
\$4,305

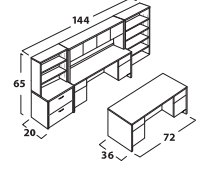

- MM5**
 1 MMD3672 \$1,178
 1 MMC2072 3 \$1,146
 1 MMH72WD \$1,125
 1 MMLF202 \$856
 1 MMBCH \$411
 1 MMBC3665 \$672
\$5,388

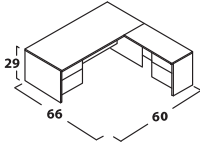

- MM6R**
 1 MMS3060L \$788
 1 MMRA2036R \$644
\$1,432

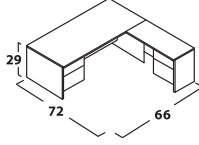

- MM7R**
 1 MMS3066L \$883
 1 MMRA2442R \$762
\$1,645

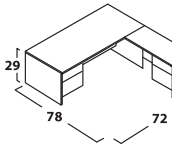

- MM8R**
 1 MMS3672L \$946
 1 MMRA2442R \$762
\$1,708

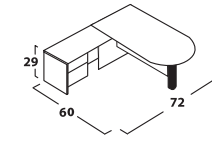

- MM9L**
 1 MMBD3060L \$747
 1 MMRA2042L \$657
\$1,404

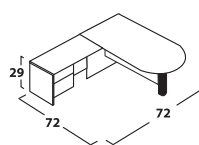

- MM10L**
 1 MMBD3672L \$911
 1 MMRA2436L \$735
\$1,646

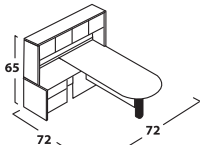

- MM11L**
 1 MMBD3672L \$911
 1 MMRA2436L \$735
 1 MMH72WD \$1,125
\$2,771

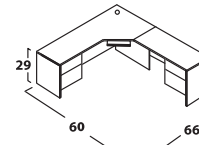

- MM12R**
 1 MMCD60 2L \$932
 1 MMRA2036R \$644
\$1,576

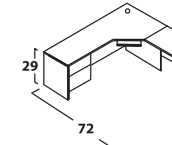

- MM13R**
 1 MMCD66 4L \$1,021
 1 MMRA2436R \$735
\$1,756

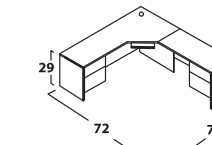

- MM14R**
 1 MMCD72 4L \$974
 1 MMRA2436R \$735
\$1,709

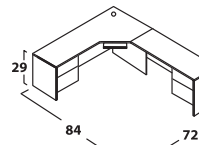

- MM15R**
 1 MMCD72 4L \$974
 1 MMRA2448R \$774
\$1,748

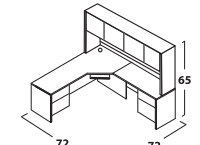

- MM16R**
 1 MMCD72 4L \$974
 1 MMRA2436R \$735
 1 MMH72WD \$1,125
\$2,834

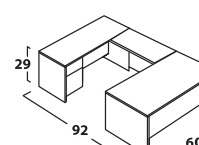

- MM17L**
 1 MMS3060R \$788
 1 MMBR2042 \$240
 1 MMC2060 4L \$762
\$1,790

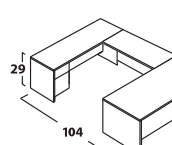

- MM18L**
 1 MMS3672R \$946
 1 MMBR2448 \$363
 1 MMC2072 4L \$871
\$2,180

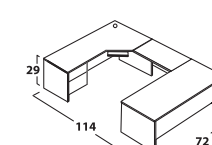

- MM19L**
 1 MMS3672R \$946
 1 MMBR2442 \$322
 1 MMCD72 4L \$974
\$2,242

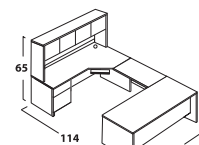

- MM20L**
 1 MMS3672R \$946
 1 MMBR2442 \$322
 1 MMCD72 4L \$974
 1 MMH72WD \$1,125
\$3,367

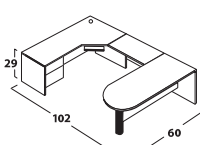

- MM21L**
 1 MMBD3060L \$747
 1 MMBR2042 \$240
 1 MMCD60 2L \$932
\$1,919

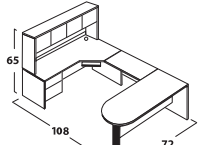

- MM22L**
 1 MMBD3072L \$856
 1 MMBR2442 \$322
 1 MMCD72 4L \$974
 1 MMH72WD \$1,125
\$3,277

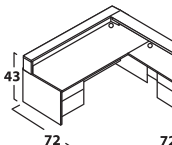

- MM23R**
 1 MMS3072L \$898
 1 MMRA2442R \$762
 1 MMRB72 \$657
 1 MMRBR60R \$521
 2 MM GR234 \$45
\$2,883

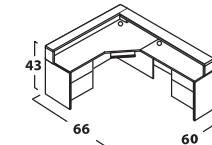

- MM24R**
 1 MMCD60 2L \$932
 1 MMRA2036R \$644
 1 MMRB60 \$521
 1 MMRBR54R \$440
 1 MM GR234 \$45
\$2,582

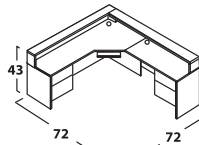

- MM25R**
 1 MMCD72 4L \$974
 1 MMRA2436R \$735
 1 MMRB72 \$657
 1 MMRBR60R \$521
 1 MM GR234 \$45
\$2,932

Maverick Series - Curved



Curved Configurations

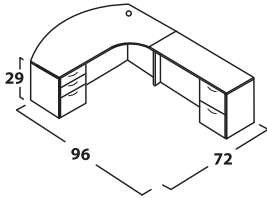

MQ1R

1 MMFCDQ72C9L	\$1,777
1 MMRD2448R SPTL	\$1,167
1 MMUHL2	\$51
1 MMUHL3	\$75
	\$3,070

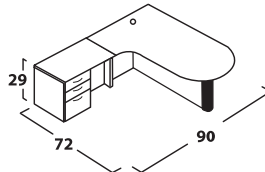

MQ2L

1 MMBDCQ427230L FMP	\$974
1 MMRC2448L SPTR	\$1,167
1 MMUHL3	\$75
	\$2,216

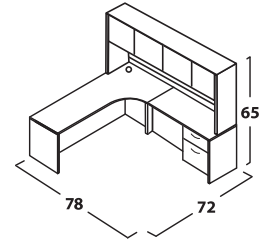

MQ3R

1 MMCDNQ72 4R FMP	\$930
1 MMRA2436R SPTL, H3B	\$891
1 MMH 72 WD	\$1,125
	\$2,946

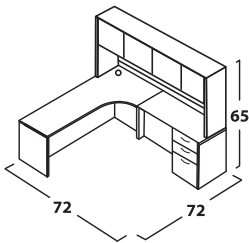

MQ4R

1 MMCDNQ72 4R FMP	\$930
1 MMRC2436R SPTL, H3B	\$993
1 MMH72 WD	\$1,125
	\$3,048

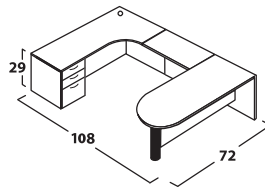

MQ5L

1 MMBD3672 FMP	\$970
1 MMBR2436 FMP	\$314
1 MMCDQ72C4L, H3B	\$1,055
	\$2,339

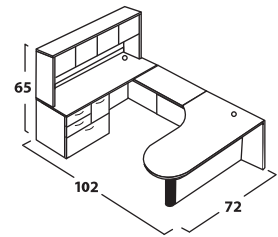

MQ6L

1 MMBDCQ427230L FMP	\$1,033
1 MMBR2436 FMP	\$314
1 MMC24726L	\$1,657
1 MMGR234B RIGHT	\$45
1 MMH72 WD	\$1,125
	\$4,174

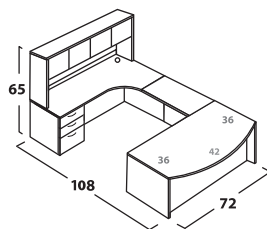

MQ7L

1 MMN 3672 FMP	\$703
1 MMFAN (Adds 6"D)	\$261
1 MMBR2436 FMP	\$314
1 MMCDNQ72 4R FMP	\$930
1 MMPED CM w H3B	\$767
1 MMH72 WD	\$1,127
	\$4,102

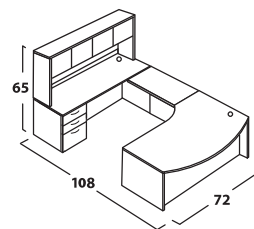

MQ8L

1 MMFCDNQ72 9L FMP	\$1,184
1 MMBR2436 FMP	\$314
1 MMN2472 FMP	\$689
1 MM GR234 RIGHT	\$45
1 MMPED CM w H3B, PL	\$737
1 MMH72 WD	\$1,125
	\$4,094



Maverick Series

Quickship Teaming Set-up Suggestions

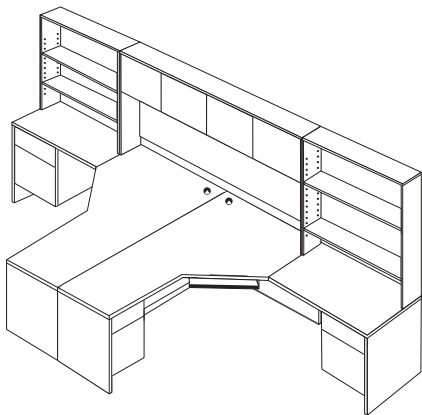

- 1 MMCD72 4R \$974
- 1 MMCD72 4L \$974
- 1 MMRA2436R \$735
- 1 MMRA2436L \$735
- 2 MMBCH \$822
- 1 MMH72 WD \$1,125
- \$5,365**

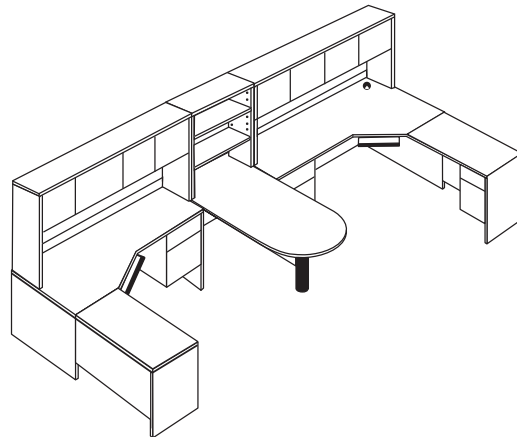

- 1 MMCD72 4R \$974
- 1 MMCD72 4L \$974
- 1 MMRA2436R \$735
- 1 MMRA2436L \$735
- 1 MMBD3672 L \$911
- 2 MMH72WD \$2,250
- 1 MMBCH \$411
- \$6,990**

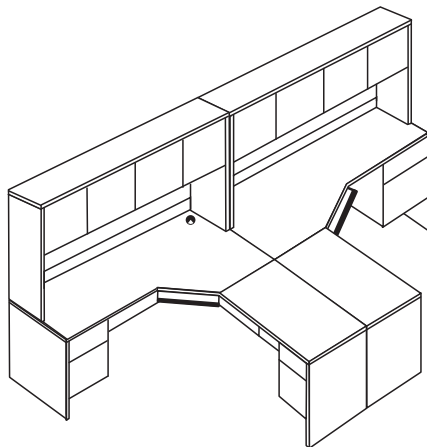

- 1 MMCD72 4R \$974
- 1 MMCD72 4L \$974
- 1 MMRA2436R \$735
- 1 MMRA2436L \$735
- 2 MMH72WD \$2,250
- \$5,668**

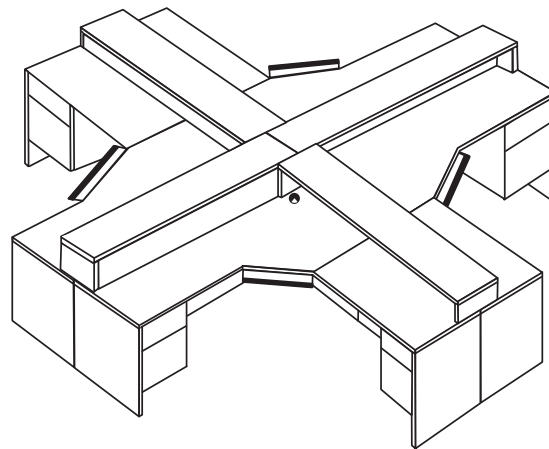

- 2 MMCD72 4R \$1,948
- 2 MMCD72 4L \$1,948
- 2 MMRA2436R \$1,470
- 2 MMRA2436L \$1,470
- 2 MMRB66 \$1,178
- 2 MMRB72 \$1,314
- \$9,328**

For pricing on other Maverick Series teaming set-ups, contact your sales representative or Customer Service.

Maverick Series



Desks

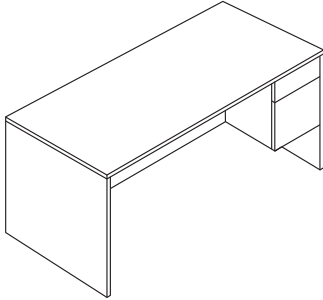

Single Pedestal Desk, Box/File Pedestal (¼ Modesty), Right

Model#	Depth	Width	Height	Weight	Cube	Price
MMS2042R	20"	42"	29"	120	15	\$719
MMS2060R	20"	60"	29"	150	20	\$774
MMS2066R	20"	66"	29"	156	23	\$871
MMS2072R	20"	72"	29"	163	24	\$883
MMS2442R	24"	42"	29"	127	18	\$747
MMS2448R	24"	48"	29"	130	20	\$762
MMS3048R	30"	48"	29"	142	25	\$773
MMS3060R	30"	60"	29"	190	32	\$788
MMS3066R	30"	66"	29"	197	35	\$883
MMS3072R	30"	72"	29"	210	38	\$899
MMS3672R	36"	72"	29"	225	45	\$946

For handles and pedestal lock, add MMUHL2...\$51 (Specify H3B-H14, see p. 43).
For full modesty panel upgrade, add MMFMP...\$59

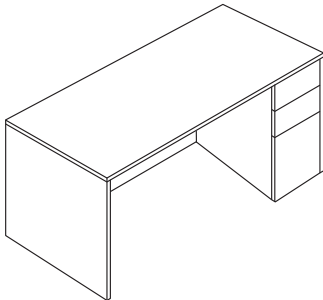

Single Pedestal Desk, Box/Box/File Pedestal (Full Modesty), Right

Model#	Depth	Width	Height	Weight	Cube	Price
MMSC2042R	20"	42"	29"	155	15	\$1,049
MMSC2060R	20"	60"	29"	180	20	\$1,102
MMSC2066R	20"	66"	29"	190	23	\$1,201
MMSC2072R	20"	72"	29"	200	24	\$1,213
MMSC2442R	24"	42"	29"	175	18	\$1,077
MMSC2448R	24"	48"	29"	183	20	\$1,091
MMSC3048R	30"	48"	29"	203	25	\$1,102
MMSC3060R	30"	60"	29"	224	32	\$1,117
MMSC3066R	30"	66"	29"	234	35	\$1,213
MMSC3072R	30"	72"	29"	244	38	\$1,227
MMSC3672R	36"	72"	29"	267	45	\$1,275

For handles and pedestal lock, add MMUHL3...\$75 (Specify H3B-H14, see p. 43).

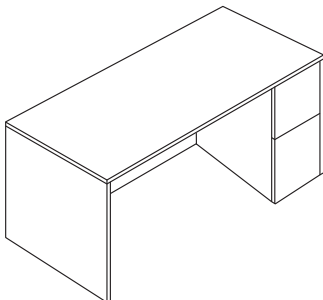

Single Pedestal Desk, File/File Pedestal (Full Modesty), Right

Model#	Depth	Width	Height	Weight	Cube	Price
MMSD2042R	20"	42"	29"	155	15	\$1,012
MMSD2060R	20"	60"	29"	180	20	\$1,065
MMSD2066R	20"	66"	29"	190	23	\$1,162
MMSD2072R	20"	72"	29"	200	24	\$1,175
MMSD2442R	24"	42"	29"	175	18	\$1,037
MMSD2448R	24"	48"	29"	183	20	\$1,052
MMSD3048R	30"	48"	29"	203	25	\$1,065
MMSD3060R	30"	60"	29"	224	32	\$1,080
MMSD3066R	30"	66"	29"	234	35	\$1,175
MMSD3072R	30"	72"	29"	244	38	\$1,190
MMSD3672R	36"	72"	29"	267	45	\$1,238

For handles and pedestal lock, add MMUHL2...\$51 (Specify H3B-H14, see p. 43).

Maverick Series

Desks

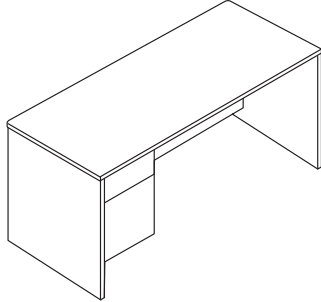

Single Pedestal Desk, Box/File Pedestal (¾ modesty), Left

Model#	Depth	Width	Height	Weight	Cube	Price
MMS2042L	20"	42"	29"	120	15	\$719
MMS2060L	20"	60"	29"	150	20	\$774
MMS2066L	20"	66"	29"	156	23	\$871
MMS2072L	20"	72"	29"	163	24	\$883
MMS2442L	24"	42"	29"	127	18	\$747
MMS2448L	24"	48"	29"	130	20	\$762
MMS3048L	30"	48"	29"	142	25	\$773
MMS3060L	30"	60"	29"	190	32	\$788
MMS3066L	30"	66"	29"	197	35	\$883
MMS3072L	30"	72"	29"	210	38	\$899
MMS3672L	36"	72"	29"	225	45	\$946

For handles and pedestal lock, add MMUHL2...\$51 (Specify H3B-H14, see p. 43).

For full modesty panel upgrade, add MMFMP...\$59.

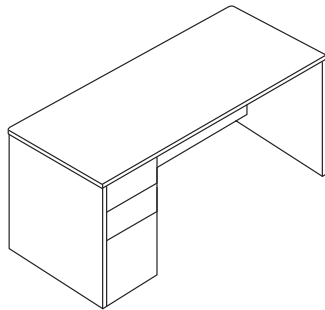

Single Pedestal Desk, Box/Box/File Pedestal (Full modesty), Left

Model#	Depth	Width	Height	Weight	Cube	Price
MMSC2042L	20"	42"	29"	155	15	\$1,049
MMSC2060L	20"	60"	29"	180	20	\$1,102
MMSC2066L	20"	66"	29"	190	23	\$1,201
MMSC2072L	20"	72"	29"	200	24	\$1,213
MMSC2442L	24"	42"	29"	175	18	\$1,077
MMSC2448L	24"	48"	29"	183	20	\$1,091
MMSC3048L	30"	48"	29"	203	25	\$1,102
MMSC3060L	30"	60"	29"	224	32	\$1,117
MMSC3066L	30"	66"	29"	234	35	\$1,213
MMSC3072L	30"	72"	29"	244	38	\$1,227
MMSC3672L	36"	72"	29"	267	45	\$1,275

For handles and pedestal lock, add MMUHL3...\$75 (Specify H3B-H14, see p. 43).

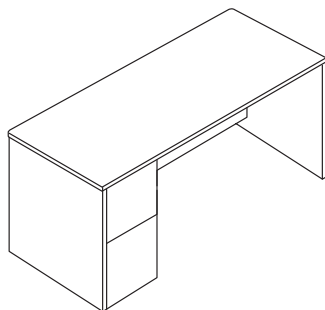

Single Pedestal Desk, File/File Pedestal (Full Modesty), Left

Model#	Depth	Width	Height	Weight	Cube	Price
MMSD2042L	20"	42"	29"	155	15	\$1,012
MMSD2060L	20"	60"	29"	180	20	\$1,065
MMSD2066L	20"	66"	29"	190	23	\$1,162
MMSD2072L	20"	72"	29"	200	24	\$1,175
MMSD2442L	24"	42"	29"	175	18	\$1,037
MMSD2448L	24"	48"	29"	183	20	\$1,052
MMSD3048L	30"	48"	29"	203	25	\$1,065
MMSD3060L	30"	60"	29"	224	32	\$1,080
MMSD3066L	30"	66"	29"	234	35	\$1,175
MMSD3072L	30"	72"	29"	244	38	\$1,190
MMSD3672L	36"	72"	29"	267	45	\$1,238

For handles and pedestal lock, add MMUHL2...\$51 (Specify H3B-H14, see p. 43).

Maverick Series



Desks

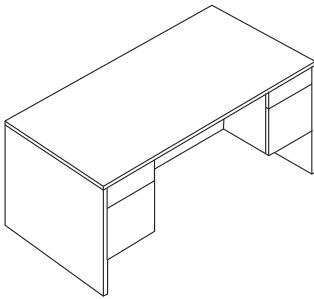

Double Pedestal Desk, Box/File Pedestals (¾ Modesty), Left and Right

Model#	Depth	Width	Height	Weight	Cube	Price
MMD3060	30"	60"	29"	260	32	\$946
MMD3066	30"	66"	29"	266	35	\$1,145
MMD3072	30"	72"	29"	270	38	\$1,165
MMD3672	36"	72"	29"	276	45	\$1,178

For handles and pedestal lock, add MMUHL2...\$51 each (Specify H3B-H14, see p. 43).
For full modesty panel upgrade, add MMFMP...\$59

Double Pedestal Desk, Box/Box/File Pedestals (Full Modesty), Left and Right

Model#	Depth	Width	Height	Weight	Cube	Price
MMDC3060	30"	60"	29"	294	32	\$1,275
MMDC3066	30"	66"	29"	304	35	\$1,520
MMDC3072	30"	72"	29"	314	38	\$1,542
MMDC3672	36"	72"	29"	337	45	\$1,556

For handles and pedestal lock, add MMUHL3...\$75 each (Specify H3B-H14, see p. 43).
For File/File, Box/Box/File configuration, please specify...N/C.

Double Pedestal Desk, File/File Pedestals (Full Modesty), Left and Right

Model#	Depth	Width	Height	Weight	Cube	Price
MMDD3060	30"	60"	29"	294	32	\$1,238
MMDD3066	30"	66"	29"	304	35	\$1,483
MMDD3072	30"	72"	29"	314	38	\$1,503
MMDD3672	36"	72"	29"	337	45	\$1,517

For handles and pedestal lock, add MMUHL2...\$51 each (Specify H3B-H14, see p. 43).

No-Pedestal Credenza (Flush ¾ Modesty, 20" & 24"D)

Model#	Depth	Width	Height	Weight	Cube	Price
MMN2042	20"	42"	29"	84	17	\$425
MMN2048	20"	48"	29"	84	17	\$439
MMN2060	20"	60"	29"	92	20	\$473
MMN2066	20"	66"	29"	96	23	\$507
MMN2072	20"	72"	29"	100	24	\$521
MMN2436	24"	36"	29"	89	16	\$430
MMN2442	24"	42"	29"	95	18	\$473
MMN2448	24"	48"	29"	104	20	\$487
MMN2460	24"	60"	29"	120	25	\$521
MMN2466	24"	66"	29"	127	28	\$589
MMN2472	24"	72"	29"	132	30	\$630

No-Pedestal Desk (Inset Modesty...30"D-6" Inset Modesty, 36"D-12" Inset Modesty)

MMN3042	30"	42"	29"	114	22	\$521
MMN3048	30"	48"	29"	120	25	\$535
MMN3060	30"	60"	29"	126	32	\$550
MMN3066	30"	66"	29"	132	35	\$610
MMN3072	30"	72"	29"	138	38	\$630
MMN3672	36"	72"	29"	152	45	\$644

For left or right 1/2 leg specify on order...N/C. For full modesty panel upgrade, add MMFMP...\$59.
For fan top desk, add upgrade MMFAN...\$261 (Center depth increases by 6")



See available accessories and upgrades, pp. 49-54

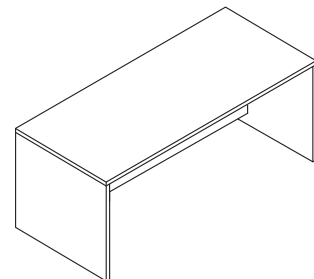
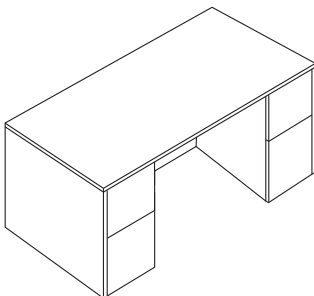
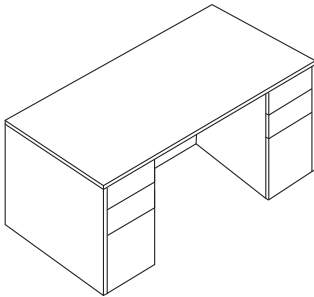



Maverick Series

Desks

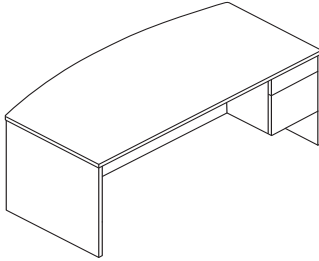

Fan Top Single Pedestal Conference Desk, Box/File Pedestal (¾ modesty), Right

	Model#	Depth	Width	Height	Weight	Cube	Price
	MMFS3672R	30-36"	72"	29"	233	45	\$1,165
	MMFS4272R	36-42"	72"	29"	258	53	\$1,206

For handles and pedestal lock, add MMUHL2...\$51 each (Specify H3B-H14, see p. 43).
For full modesty panel upgrade, add MMFMP...\$59.

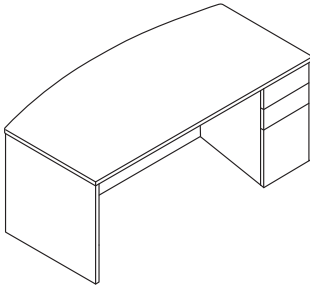

Fan Top Single Pedestal Conference Desk, Box/Box/File Pedestal (Full modesty), Right

	Model#	Depth	Width	Height	Weight	Cube	Price
	MMFSC3672R	30-36"	72"	29"	265	45	\$1,495
	MMFSC4272R	36-42"	72"	29"	280	53	\$1,535

For handles and pedestal lock, add MMUHL3...\$75 (Specify H3B-H14, see p. 43).

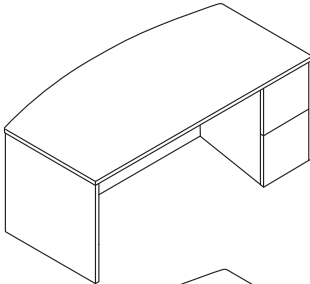

Fan Top Single Pedestal Conference Desk, File/File Pedestal (Full modesty), Right

	Model#	Depth	Width	Height	Weight	Cube	Price
	MMFSD3672R	30-36"	72"	29"	265	45	\$1,456
	MMFSD4272R	36-42"	72"	29"	280	53	\$1,496

For handles and pedestal lock, add MMUHL2...\$51 (Specify H3B-H14, see p. 43).

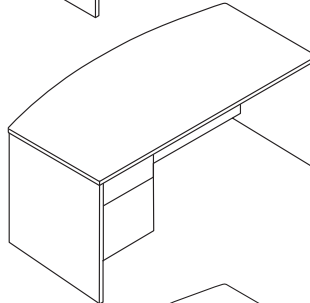

Fan Top Single Pedestal Conference Desk, Box/File Pedestal (¾ modesty), Left

	Model#	Depth	Width	Height	Weight	Cube	Price
	MMFS3672L	30-36"	72"	29"	233	45	\$1,165
	MMFS4272L	36-42"	72"	29"	258	53	\$1,206

For handles and pedestal lock, add MMUHL2...\$51 each (Specify H3B-H14, see p. 43).
For full modesty panel upgrade, add MMFMP...\$59.

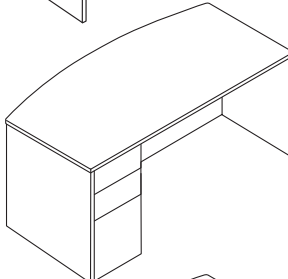

Fan Top Single Pedestal Conference Desk, Box/Box/File Pedestal (Full modesty), Left

	Model#	Depth	Width	Height	Weight	Cube	Price
	MMFSC3672L	30-36"	72"	29"	265	45	\$1,495
	MMFSC4272L	36-42"	72"	29"	280	53	\$1,535

For handles and pedestal lock, add MMUHL3...\$75 (Specify H3B-H14, see p. 43).

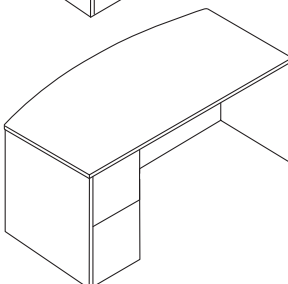

Fan Top Single Pedestal Conference Desk, File/File Pedestal (Full modesty), Left

	Model#	Depth	Width	Height	Weight	Cube	Price
	MMFSD3672L	30-36"	72"	29"	265	45	\$1,456
	MMFSD4272L	36-42"	72"	29"	280	53	\$1,496

For handles and pedestal lock, add MMUHL2...\$51 (Specify H3B-H14, see p. 43).

See available accessories and upgrades, pp. 49-54

Maverick Series



Desks

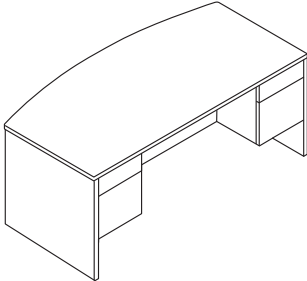

Fan Top Double Pedestal Conference Desk, Box/File Pedestals (¾ modesty), Left and Right

	Model#	Depth	Width	Height	Weight	Cube	Price
	MMFD3672	30-36"	72"	29"	280	45	\$1,420
	MMFD4272	36-42"	72"	29"	305	53	\$1,433

For handles and pedestal lock, add MMUHL2...\$51 each (Specify H3B-H14, see p. 43).
For full modesty panel upgrade, add MMFMP...\$59.

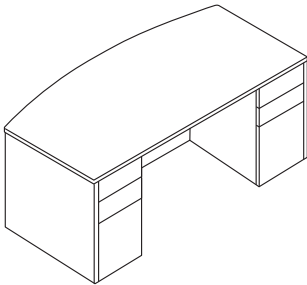

Fan Top Double Pedestal Conference Desk, Box/Box/File Pedestals (Full modesty), Left and Right

	Model#	Depth	Width	Height	Weight	Cube	Price
	MMFDC3672	30-36"	72"	29"	335	45	\$1,749
	MMFDC4272	36-42"	72"	29"	350	53	\$1,762

For handles and pedestal lock, add MMUHL3...\$75 each (Specify H3B-H14, see p. 43).
For File/File, Box/Box/File configuration please specify...N/C.

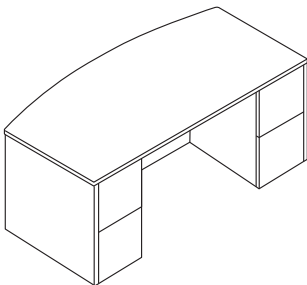

Fan Top Double Pedestal Conference Desk, File/File Pedestals (Full modesty), Left and Right

	Model#	Depth	Width	Height	Weight	Cube	Price
	MMFDD3672	30-36"	72"	29"	335	45	\$1,711
	MMFDD4272	36-42"	72"	29"	350	53	\$1,723

For handles and pedestal lock, add MMUHL2...\$51 each (Specify H3B-H14, see p. 43).

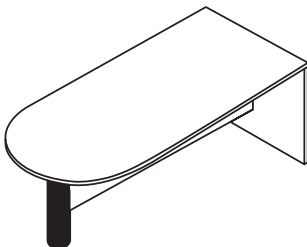

Bullet Desk, (¾ modesty, 4" black post)

	Model#	Depth	Width	Height	Weight	Cube	Price
	MMBD3060	30"	60"	29"	180	32	\$747
	MMBD3072	30"	72"	29"	195	35	\$856
	MMBD3660	36"	60"	29"	185	38	\$856
	MMBD3672	36"	72"	29"	205	45	\$911

For full modesty panel upgrade, add MMFMP...\$59. For silver post upgrade, add MMUHLEGJS...\$26.
Setup for left and right connection.



Maverick Series

Desks

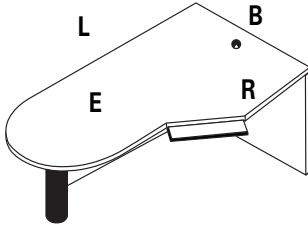

Bullet Computer Desk (¾ modesty, 4" black post), For Right Return

	Model#	Depth (B,E)	Width (L,R)	Height	Weight	Cube	Price
	MMBDC427230R	42/30"	72"/24"	29"	195	53	\$974
	MMBDC427830R	42/30"	78"/24"	29"	205	58	\$1,193

Keyboard tray, worksurface black grommet standard. Upgrade grommet cover to silver, N/C.
For silver post upgrade, add MMUHLEGJS...\$26. For full modesty panel upgrade, add MMFMP...\$59.

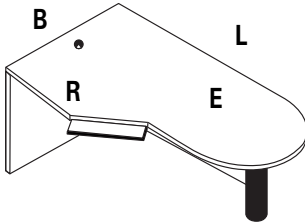

Bullet Computer Desk (¾ modesty, 4" black post), For Left Return

	Model#	Depth (B,E)	Width (L,R)	Height	Weight	Cube	Price
	MMBDC427230L	42/30"	72"/24"	29"	195	53	\$974
	MMBDC427830L	42/30"	78"/24"	29"	205	58	\$1,193

Keyboard tray, worksurface black grommet standard. Upgrade grommet cover to silver, N/C.
For silver post upgrade, add MMUHLEGJS...\$26. For full modesty panel upgrade, add MMFMP...\$59.

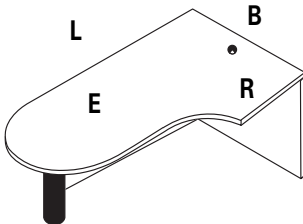

Bullet Computer Desk, Curved (¾ modesty, 4" black post), For Right Return

	Model#	Depth (B,E)	Width (L,R)	Height	Weight	Cube	Price
	MMBDCQ427230R	42/30"	72"/24"	29"	195	53	\$974

Worksurface black grommet standard. Upgrade grommet cover to silver, N/C.
For silver post upgrade, add MMUHLEGJS...\$26. For full modesty panel upgrade, add MMFMP...\$59.

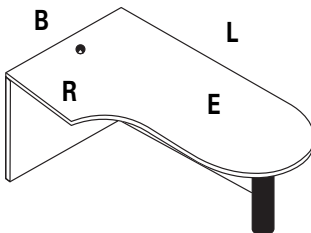

Bullet Computer Desk, Curved (¾ modesty, 4" black post), For Left Return

	Model#	Depth (B,E)	Width (L,R)	Height	Weight	Cube	Price
	MMBDCQ427230L	42/30"	72"/24"	29"	195	53	\$974

Worksurface black grommet standard. Upgrade grommet cover to silver, N/C.
For silver post upgrade, add MMUHLEGJS...\$26. For full modesty panel upgrade, add MMFMP...\$59.

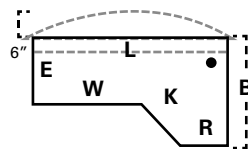

- "L" Length along approach edge
- "B" Back end panel (Fan top adds 6")
- "E" End panel
- "K" Keyboard space
- "R" Return size to attach
- "W" Workarea (kbrd to end)

Maverick Series



Desks

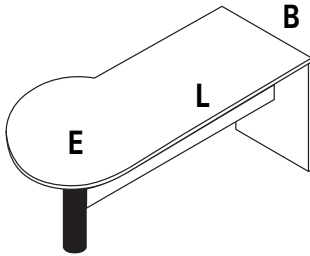

P-shape Desk (¾ modesty, 4" black post), For Right Return

Model#	Depth (B,E)	Width (L)	Height	Weight	Cube	Price
MMPBD3072R	30/36"	72"	29"	200	45	\$1,041
MMPBD3672R	36/42"	72"	29"	205	53	\$1,097
MMPBD3678R	36/42"	78"	29"	215	49	\$1,193
MMPBD3684R	36/42"	84"	29"	225	62	\$1,378

For silver post upgrade, add MMUHLEGJS...\$26. For full modesty panel upgrade, add MMFMP...\$59.

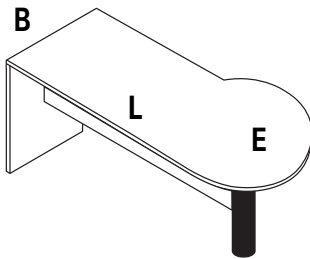

P-shape Desk (¾ modesty, 4" black post), For Left Return

Model#	Depth (B,E)	Width (L)	Height	Weight	Cube	Price
MMPBD3072L	30/36"	72"	29"	200	45	\$1,041
MMPBD3672L	36/42"	72"	29"	205	53	\$1,097
MMPBD3678L	36/42"	78"	29"	215	49	\$1,193
MMPBD3684L	36/42"	84"	29"	225	62	\$1,378

For silver post upgrade, add MMUHLEGJS...\$26. For full modesty panel upgrade, add MMFMP...\$59.

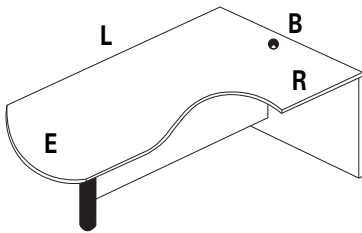

Arc End Computer Desk (¾ modesty, 4" black post), For Right Return

Model#	Depth (B,E)	Width (L,R)	Height	Weight	Cube	Price
MMAE427236R	42/36"	72"/24"	29"	205	53	\$1,207
MMAE427836R	42/36"	78"/24"	29"	215	58	\$1,312

Black grommet standard. Upgrade grommet cover to silver, N/C. For silver post upgrade, add MMUHLEGJS...\$26. For full modesty panel upgrade, add MMFMP...\$59.

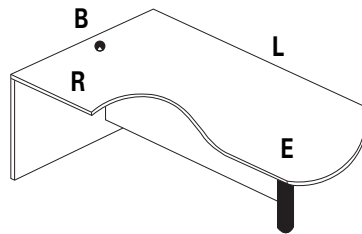

Arc End Computer Desk (¾ modesty, 4" black post), For Left Return

Model#	Depth (B,E)	Width (L,R)	Height	Weight	Cube	Price
MMAE427236L	42/36"	72"/24"	29"	205	53	\$1,207
MMAE427836L	42/36"	78"/24"	29"	215	58	\$1,312

Black grommet standard. Upgrade grommet cover to silver, N/C. For silver post upgrade, add MMUHLEGJS...\$26. For full modesty panel upgrade, add MMFMP...\$59.

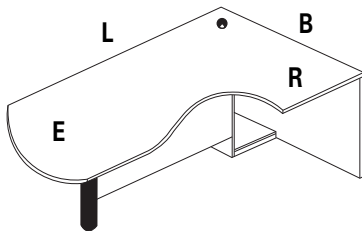

Arc End Computer Desk w/CPU Storage Cabinet (¾ modesty, 4" black post), For Right Return

Model#	Depth (B,E)	Width (L,R)	Height	Weight	Cube	Price
MMAEC427236R	42/36"	72"/24"	29"	205	53	\$1,310
MMAEC427836R	42/36"	78"/24"	29"	215	58	\$1,499

Black grommet standard. Upgrade grommet cover to silver, N/C. For silver post upgrade, add MMUHLEGJS...\$26. For full modesty panel upgrade, add MMFMP...\$59.

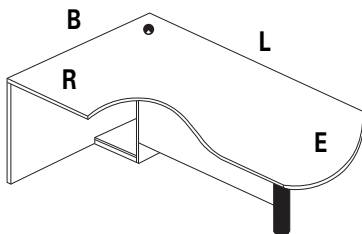

Arc End Computer Desk w/CPU Storage Cabinet (¾ modesty, 4" black post), For Left Return

Model#	Depth (B,E)	Width (L,R)	Height	Weight	Cube	Price
MMAEC427236L	42/36"	72"/24"	29"	205	53	\$1,310
MMAEC427836L	42/36"	78"/24"	29"	215	58	\$1,499

Black grommet standard. Upgrade grommet cover to silver, N/C. For silver post upgrade, add MMUHLEGJS...\$26. For full modesty panel upgrade, add MMFMP...\$59.

See available accessories and upgrades, pp. 49-54



Maverick Series

Desks

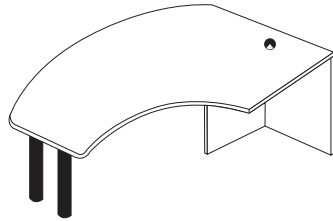

Desk, Wedge Bullet Curve (Two black 2" post legs, black grommet), For Right Return

Model#	(L)	(B)	(E)	(K)	(R)	(W)	Weight	Cube	Price
MMBWQ3672R	72"	36"+	24"	24"	24"	27"	215	45	\$1,083

Worksurface black grommet standard. No keyboard tray. Upgrade grommet color to silver, N/C.
For silver post upgrade, add MMUHLEGLS...\$14 each.

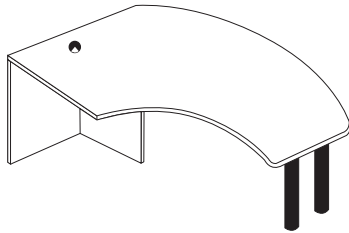

Desk, Wedge Bullet Curve (Two black 2" post legs, black grommet), For Left Return

Model#	(L)	(B)	(E)	(K)	(R)	(W)	Weight	Cube	Price
MMBWQ3672L	72"	36"+	24"	24"	24"	27"	215	45	\$1,083

Worksurface black grommet standard. No keyboard tray. Upgrade grommet color to silver, N/C.
For silver post upgrade, add MMUHLEGLS...\$14 each.

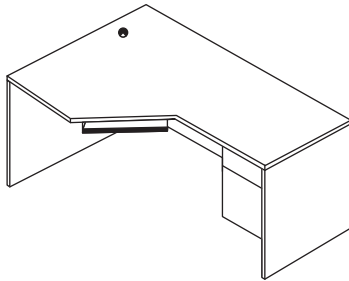

Computer Desk, Box/File Pedestal (Front unit, 3/4 modesty inset 6"), Right

Model#	(L)	(B)	(E)	(K)	(R)	(W)	Weight	Cube	Price
MMCD72 9R	72"	42"	30"	24"	24"	27"	285	45	\$1,344

Keyboard tray; worksurface black grommet standard. Upgrade grommet cover to silver, N/C.
For handles and pedestal lock, add MMUHL2...\$51 each (Specify H3B-H14, see p. 44).
For full modesty panel upgrade, add MMFMP...\$59.

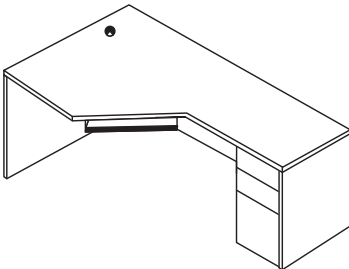

Computer Desk, Box/Box/File Pedestal (Front unit, full modesty inset 6"), Right

Model#	(L)	(B)	(E)	(K)	(R)	(W)	Weight	Cube	Price
MMCD72C 9R	72"	42"	30"	24"	24"	27"	300	45	\$1,673

Keyboard tray; worksurface black grommet standard. Upgrade grommet cover to silver, N/C.
For handles and pedestal lock, add MMUHL3...\$75 each (Specify H3B-H14, see p. 44).

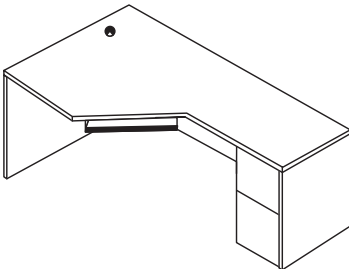

Computer Desk, File/File Pedestal (Front unit, full modesty inset 6"), Right

Model#	(L)	(B)	(E)	(K)	(R)	(W)	Weight	Cube	Price
MMCD72D 9R	72"	42"	30"	24"	24"	27"	300	45	\$1,636

Keyboard tray; worksurface black grommet are standard. Upgrade grommet cover to silver, N/C.
For handles and pedestal lock, add MMUHL2...\$51 each (Specify H3B-H14, see p. 44).

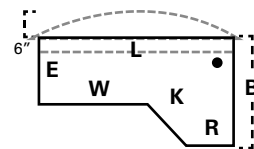

- "L" Length along approach edge
- "B" Back end panel (Fan top adds 6")
- "E" End panel
- "K" Keyboard space
- "R" Return size to attach
- "W" Workarea (kbrd to end)

Maverick Series



Desks

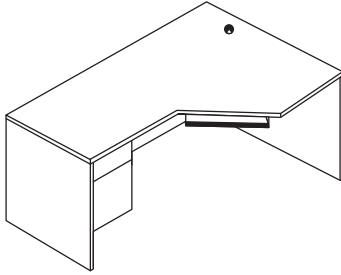

Computer Desk, Box/File Pedestal (Front unit, ³/₄ modesty inset 6"), Left

Model#	(L)	(B)	(E)	(K)	(R)	(W)	Weight	Cube	Price
MMCD72 9L	72"	42"	30"	24"	24"	27"	285	45	\$1,344

Keyboard tray, worksurface black grommet standard. Upgrade grommet cover to silver, N/C.
For handles and pedestal lock, add MMUHL2...\$51 each (Specify H3B-H14, see p. 43).
For full modesty panel upgrade, add MMFMP...\$59.

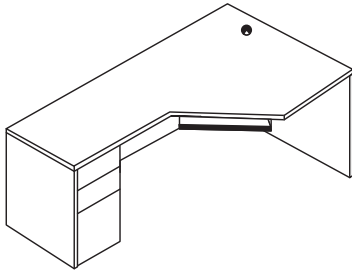

Computer Desk, Box/Box/File Pedestal (Front unit, full modesty inset 6"), Left

Model#	(L)	(B)	(E)	(K)	(R)	(W)	Weight	Cube	Price
MMCD72C 9L	72"	42"	30"	24"	24"	27"	300	45	\$1,673

Keyboard tray, worksurface black grommet standard. Upgrade grommet cover to silver, N/C.
For handles and pedestal lock, add MMUHL3...\$75 each (Specify H3B-H14, see p. 43).

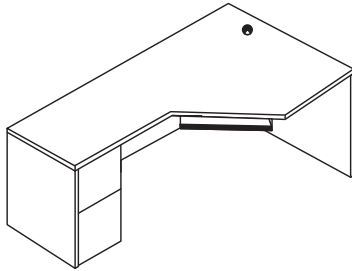

Computer Desk, File/File Pedestal (Front unit, full modesty inset 6"), Left

Model#	(L)	(B)	(E)	(K)	(R)	(W)	Weight	Cube	Price
MMCD72D 9L	72"	42"	30"	24"	24"	27"	300	45	\$1,636

Keyboard tray, worksurface black grommet standard. Upgrade grommet cover to silver, N/C.
For handles and pedestal lock, add MMUHL2...\$51 each (Specify H3B-H14, see p. 43).

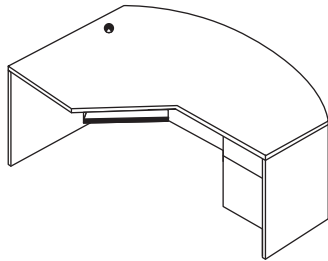

Fan Top Computer Desk, Box/File Pedestal (Front unit, ³/₄ modesty inset 6"), Right

Model#	(L)	(B)	(E)	(K)	(R)	(W)	Weight	Cube	Price
MMFCD72 9R	72"	42"+	30"	24"	24"	27"	295	48	\$1,447

Keyboard tray, worksurface black grommet standard. Fan front adds 6" to overall depth.
For handles and pedestal lock, add MMUHL2...\$51 (Specify H3B-H14, see p. 43).
For full modesty panel upgrade, add MMFMP...\$59. Upgrade grommet cover to silver, N/C.

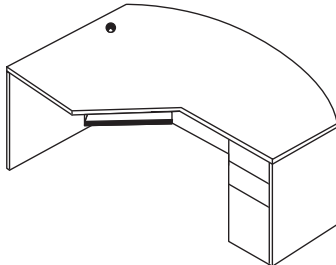

Fan Top Computer Desk, Box/Box/File Pedestal, (Front Unit, full modesty inset 6"), Right

Model#	(L)	(B)	(E)	(K)	(R)	(W)	Weight	Cube	Price
MMFCD72C 9R	72"	42"+	30"	24"	24"	27"	310	48	\$1,777

Keyboard tray, worksurface black grommet standard. Fan front adds 6" to overall depth.
For handles and pedestal lock, add MMUHL3...\$75 (Specify H3B-H14, see p. 43).
Upgrade grommet cover to silver, N/C.

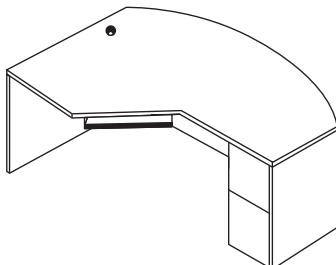

Fan Top Computer Desk, File/File Pedestal (Front Unit, full modesty inset 6"), Right

Model#	(L)	(B)	(E)	(K)	(R)	(W)	Weight	Cube	Price
MMFCD72D 9R	72"	42"+	30"	24"	24"	27"	310	48	\$1,738

Keyboard tray, worksurface black grommet standard. Fan front adds 6" to overall depth.
For handles and pedestal lock, add MMUHL2...\$51 (Specify H3B-H14, see p. 43).
Upgrade grommet cover to silver, N/C.



Maverick Series

Desks

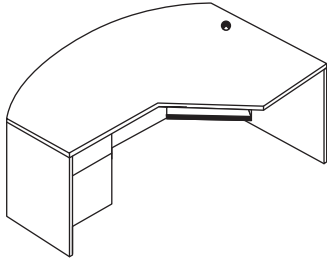

Fan Top Computer Desk, Box/File Pedestal (Front unit, ³/₄ modesty inset 6"), Left

Model#	(L)	(B)	(E)	(K)	(R)	(W)	Weight	Cube	Price
MMFCD72 9L	72"	42"+	30"	24"	24"	27"	295	48	\$1,447

Keyboard tray, worksurface black grommet standard. Upgrade grommet cover to silver, N/C.
Fan front adds 6" to overall depth. For handles and pedestal lock, add MMUHL2...\$51 (Specify H3B-H14, see p. 43).
For full modesty panel upgrade, add MMFMP...\$59.

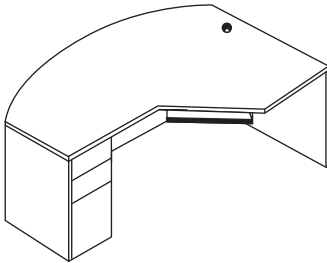

Fan Top Computer Desk, Box/Box/File Pedestal (Front unit, full modesty inset 6"), Left

Model#	(L)	(B)	(E)	(K)	(R)	(W)	Weight	Cube	Price
MMFCD72C 9L	72"	42"+	30"	24"	24"	27"	310	48	\$1,777

Keyboard tray, worksurface black grommet standard. Upgrade grommet cover to silver, N/C.
Fan front adds 6" to overall depth. For handles and pedestal lock, add MMUHL3...\$75 (Specify H3B-H14, see p. 43).

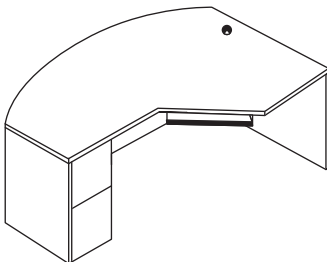

Fan Top Computer Desk, File/File Pedestal (Front unit, full modesty inset 6"), Left

Model#	(L)	(B)	(E)	(K)	(R)	(W)	Weight	Cube	Price
MMFCD72D 9L	72"	42"+	30"	24"	24"	27"	310	48	\$1,738

Keyboard tray, worksurface black grommet standard. Upgrade grommet cover to silver, N/C.
Fan front adds 6" to overall depth. For handles and pedestal lock, add MMUHL2...\$51 (Specify H3B-H14, see p. 43).

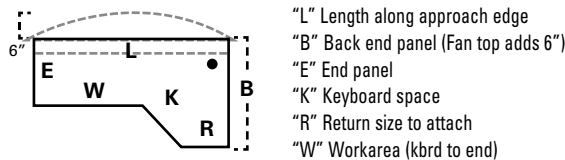

Maverick Series



Desks

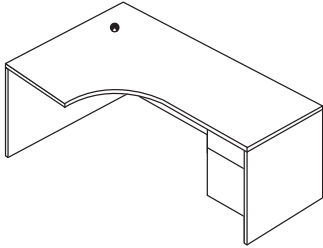

Computer Desk, Curved, Box/File Pedestal (Front unit, ³/₄ modesty inset 6"), Right

Model#	(L)	(B)	(E)	(K)	(R)	(W)	Weight	Cube	Price
MMCDQ72 9R	72"	42"	30"	24"	24"	27"	285	45	\$1,344

No keyboard tray. Worksurface black grommet standard. Upgrade grommet cover to silver, N/C.
For handles and pedestal lock, add MMUHL2...\$51 (Specify H3B-H14, see p. 43).
For full modesty panel upgrade, add MMFMP...\$59.

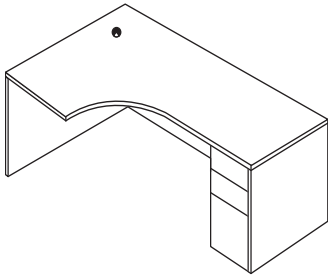

Computer Desk, Curved, Box/Box/File Pedestal (Front unit, Full modesty inset 6"), Right

Model#	(L)	(B)	(E)	(K)	(R)	(W)	Weight	Cube	Price
MMCDQ72C 9R	72"	42"	30"	24"	24"	27"	300	45	\$1,673

No keyboard tray. Worksurface black grommet standard. Upgrade grommet cover to silver, N/C.
For handles and pedestal lock, add MMUHL3...\$75 (Specify H3B-H14, see p. 43).

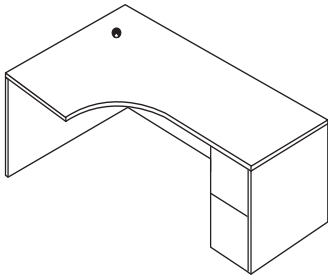

Computer Desk, Curved, File/File Pedestal (Front unit, full modesty inset 6"), Right

Model#	(L)	(B)	(E)	(K)	(R)	(W)	Weight	Cube	Price
MMCDQ72D 9R	72"	42"	30"	24"	24"	27"	300	45	\$1,636

No keyboard tray. Worksurface black grommet standard. Upgrade grommet cover to silver, N/C.
For handles and pedestal lock, add MMUHL3...\$51 (Specify H3B-H14, see p. 43).

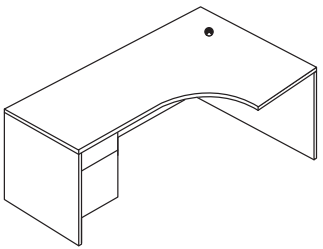

Computer Desk, Curved, Box/File Pedestal (Front unit, ³/₄ modesty inset 6"), Left

Model#	(L)	(B)	(E)	(K)	(R)	(W)	Weight	Cube	Price
MMCDQ72 9L	72"	42"	30"	24"	24"	27"	285	45	\$1,344

No keyboard tray. Worksurface black grommet standard. Upgrade grommet cover to silver, N/C.
For handles and pedestal lock, add MMUHL2...\$51 (Specify H3B-H14, see p. 43).
For full modesty panel upgrade, add MMFMP...\$59.

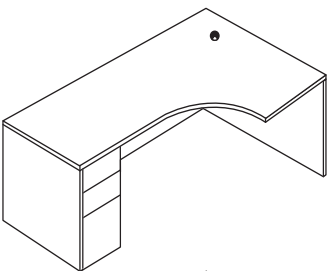

Computer Desk, Curved, Box/Box/File Pedestal (Front unit, full modesty inset 6"), Left

Model#	(L)	(B)	(E)	(K)	(R)	(W)	Weight	Cube	Price
MMCDQ72C 9L	72"	42"	30"	24"	24"	27"	300	45	\$1,673

No keyboard tray. Worksurface black grommet standard. Upgrade grommet cover to silver, N/C.
For handles and pedestal lock, add MMUHL3...\$75 (Specify H3B-H14, see p. 43).

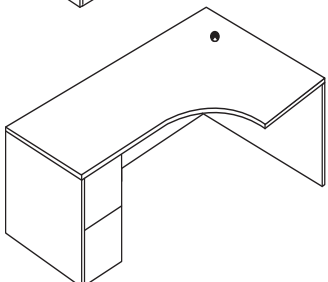

Computer Desk, Curved, File/File Pedestal (Front unit, full modesty inset 6"), Left

Model#	(L)	(B)	(E)	(K)	(R)	(W)	Weight	Cube	Price
MMCDQ72D 9L	72"	42"	30"	24"	24"	27"	300	45	\$1,636

No keyboard tray. Worksurface black grommet standard. Upgrade grommet cover to silver, N/C.
For handles and pedestal lock, add MMUHL2...\$51 (Specify H3B-H14, see p. 43).



Maverick Series

Desks

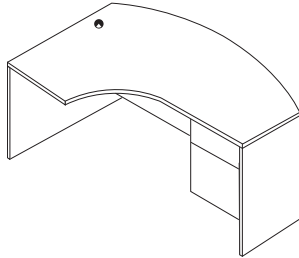

Fan Top Computer Desk, Curved, Box/File Pedestal (Front unit, ³/₄ modesty inset 6''), Right

Model#	(L)	(B)	(E)	(K)	(R)	(W)	Weight	Cube	Price
MMFCDQ72 9R	72"	42"+	30"	24"	24"	27"	295	48	\$1,447

No keyboard tray. Worksurface black grommet standard. Fan front adds 6" to overall depth.
Upgrade grommet cover to silver, N/C. For handles and pedestal lock, add MMUHL2...\$51 (Specify H3B-H14, see p. 43).
For full modesty panel upgrade, add MMFMP...\$59.

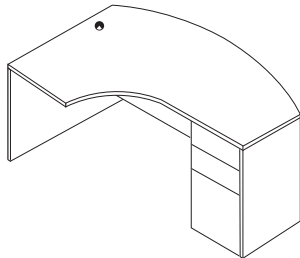

Fan Top Computer Desk, Curved, Box/Box/File Pedestal (Front unit, full modesty inset 6''), Right

Model#	(L)	(B)	(E)	(K)	(R)	(W)	Weight	Cube	Price
MMFCDQ72C 9R	72"	42"+	30"	24"	24"	27"	310	48	\$1,777

No Keyboard tray, worksurface black grommet standard. Fan front adds 6" to overall depth.
Upgrade grommet cover to silver, N/C.
For handles and pedestal lock, add MMUHL3...\$75 (Specify H3B-H14, see p. 43).

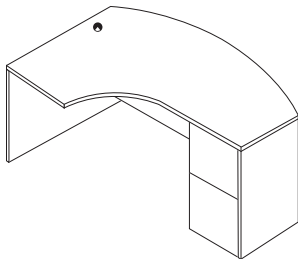

Fan Top Computer Desk, Curved, File/File Pedestal (Front unit, full modesty inset 6''), Right

Model#	(L)	(B)	(E)	(K)	(R)	(W)	Weight	Cube	Price
MMFCDQ72D 9R	72"	42"+	30"	24"	24"	27"	310	48	\$1,738

No Keyboard tray, worksurface black grommet standard. Fan front adds 6" to overall depth.
Upgrade grommet cover to silver, N/C.
For handles and pedestal lock, add MMUHL2...\$51 (Specify H3B-H14, see p. 43).

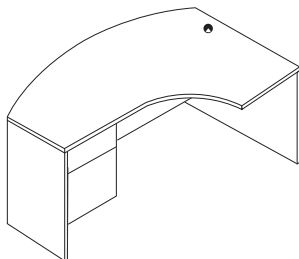

Fan Top Computer Desk, Curved, Box/File Pedestal (Front Unit, ³/₄ modesty inset 6''), Left

Model#	(L)	(B)	(E)	(K)	(R)	(W)	Weight	Cube	Price
MMFCDQ72 9L	72"	42"+	30"	24"	24"	27"	295	48	\$1,447

No Keyboard tray, worksurface black grommet standard. Fan front adds 6" to overall depth.
Upgrade grommet cover to silver, N/C.
For handles and pedestal lock, add MMUHL2...\$51 (Specify H3B-H14, see p. 43).
For full modesty panel upgrade, add MMFMP...\$59.

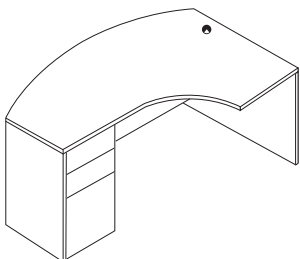

Fan Top Computer Desk, Curved, Box/Box/File Pedestal (Front unit, full modesty inset 6''), Left

Model#	(L)	(B)	(E)	(K)	(R)	(W)	Weight	Cube	Price
MMFCDQ72C 9L	72"	42"+	30"	24"	24"	27"	310	48	\$1,777

No Keyboard tray. Worksurface black grommet standard. Fan front adds 6" to overall depth.
Upgrade grommet cover to silver, N/C.
For handles and pedestal lock, add MMUHL3...\$75 (Specify H3B-H14, see p. 43).

Maverick Series



Desks

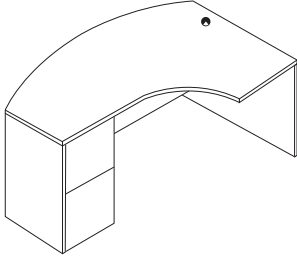

Fan Top Computer Desk, Curved, File/File Pedestal (Front unit, full modesty inset 6\"/>

Model#	(L)	(B)	(E)	(K)	(R)	(W)	Weight	Cube	Price
MMFCDQ72D 9L	72"	42"+	30"	24"	24"	27"	310	48	\$1,738

No eyboard tray, worksurface black grommet standard. Fan front adds 6" to overall depth.

Upgrade grommet cover to silver, N/C.

For handles and pedestal lock, add MMUHL2...\$51 (Specify H3B-H14, see p. 43).

For full modesty panel upgrade, add MMFMP...\$59.

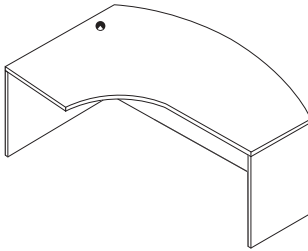

Fan Top Computer Desk Shell, Curved (Front unit, ³/₄ modesty inset 6\"/>

Model#	(L)	(B)	(E)	(K)	(R)	(W)	Weight	Cube	Price
MMFCDNQ72 9L	72"	42"+	30"	24"	24"	27"	215	48	\$1,125

No keyboard tray. Worksurface black grommet standard. Upgrade grommet cover to silver, N/C.

Fan front adds 6" to overall depth. For full modesty panel upgrade, add MMFMP...\$59.

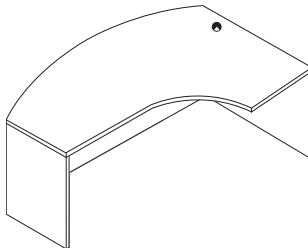

Fan Top Computer Desk Shell, Curved (Front unit, ³/₄ modesty inset 6\"/>

Model#	(L)	(B)	(E)	(K)	(R)	(W)	Weight	Cube	Price
MMFCDNQ72 9R	72"	42"+	30"	24"	24"	27"	215	48	\$1,125

No keyboard tray. Worksurface black grommet standard. Upgrade grommet cover to silver, N/C.

Fan front adds 6" to overall depth. For full modesty panel upgrade, add MMFMP...\$59.

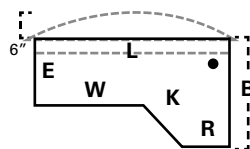

- "L" Length along approach edge
- "B" Back end panel (Fan top adds 6")
- "E" End panel
- "K" Keyboard space
- "R" Return size to attach
- "W" Workarea (kbrd to end)



Maverick Series

Bridges, Returns

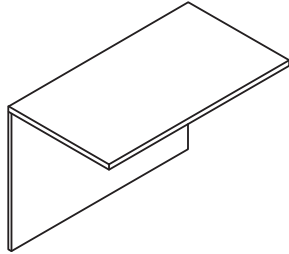

Bridge Section (³/₄ modesty, flush height), Component

	Model#	Depth	Width	Height	Weight	Cube	Price
	MMBR2036	20"	36"	19"	41	9	\$225
	MMBR2042	20"	42"	19"	48	10	\$240
	MMBR2048	20"	48"	19"	55	12	\$281
	MMBR2436	24"	36"	19"	47	10	\$255
	MMBR2442	24"	42"	19"	55	12	\$322
	MMBR2448	24"	48"	19"	63	14	\$363
	MMBR2460	24"	60"	19"	78	15	\$440

³/₄ modesty standard. ¹/₂ modesty on bridges may be specified at no upcharge.
For full modesty panel upgrade, add MMFMP...\$59.

Returns

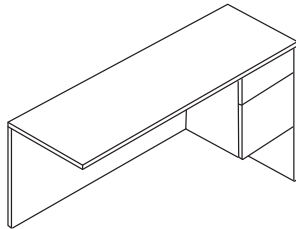

Return, ³/₄ Box/File Pedestal (³/₄ modesty, flush height), Right

	Model#	Depth	Width	Height	Weight	Cube	Price
	MMRA2036R	20"	36"	29"	95	13	\$644
	MMRA2042R	20"	42"	29"	104	15	\$657
	MMRA2048R	20"	48"	29"	110	17	\$672
	MMRA2054R	20"	54"	29"	117	19	\$699
	MMRA2436R	24"	36"	29"	100	15	\$735
	MMRA2442R	24"	42"	29"	107	18	\$762
	MMRA2448R	24"	48"	29"	114	20	\$774
	MMRA2454R	24"	54"	29"	121	23	\$830
	MMRA2460R	24"	60"	29"	124	24	\$843
	MMRA3048R	30"	48"	29"	127	25	\$843

³/₄ modesty standard. ¹/₂ modesty on returns may be specified at no upcharge.
For handles and pedestal lock, add MMUHL2...\$51 (Specify H3B-H14, see p. 43).
For full modesty panel upgrade, add MMFMP...\$59.

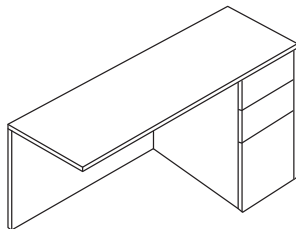

Return, Box/Box/File Pedestal (Full modesty), Right

	Model#	Depth	Width	Height	Weight	Cube	Price
	MMRC2036R	20"	36"	29"	130	13	\$975
	MMRC2042R	20"	42"	29"	140	15	\$987
	MMRC2048R	20"	48"	29"	150	17	\$1,002
	MMRC2054R	20"	54"	29"	160	19	\$1,029
	MMRC2436R	24"	36"	29"	140	15	\$1,064
	MMRC2442R	24"	42"	29"	150	18	\$1,091
	MMRC2448R	24"	48"	29"	160	20	\$1,102
	MMRC2454R	24"	54"	29"	170	23	\$1,160
	MMRC2460R	24"	60"	29"	180	24	\$1,173
	MMRC3048R	30"	48"	29"	175	25	\$1,173

Full modesty standard. ¹/₂ modesty on returns may be specified at no upcharge.
For handles and pedestal lock, add MMUHL3...\$75 (Specify H3B-H14, see p. 43).

Maverick Series



Returns

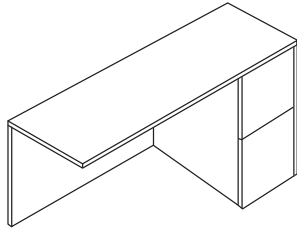

Return, File/File Pedestal (Full modesty), Right

Model#	Depth	Width	Height	Weight	Cube	Price
MMRD2036R	20"	36"	29"	130	13	\$935
MMRD2042R	20"	42"	29"	140	15	\$948
MMRD2048R	20"	48"	29"	150	17	\$963
MMRD2054R	20"	54"	29"	160	19	\$991
MMRD2436R	24"	36"	29"	140	15	\$1,026
MMRD2442R	24"	42"	29"	150	18	\$1,037
MMRD2448R	24"	48"	29"	160	20	\$1,065
MMRD2454R	24"	54"	29"	170	23	\$1,121
MMRD2460R	24"	60"	29"	180	24	\$1,133
MMRD3048R	30"	48"	29"	175	25	\$1,133

Full modesty standard. ½ modesty on returns may be specified at no upcharge.
For handles and pedestal lock, add MMUHL2...\$51 (Specify H3B-H14, see p. 43).

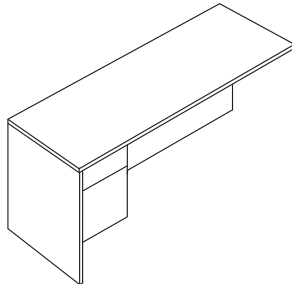

Return, ¼ Box/File Pedestal (¼ modesty), Left

Model#	Depth	Width	Height	Weight	Cube	Price
MMRA2036L	20"	36"	29"	95	13	\$644
MMRA2042L	20"	42"	29"	104	15	\$657
MMRA2048L	20"	48"	29"	110	17	\$672
MMRA2054L	20"	54"	29"	117	19	\$699
MMRA2436L	24"	36"	29"	100	15	\$735
MMRA2442L	24"	42"	29"	107	18	\$762
MMRA2448L	24"	48"	29"	114	20	\$774
MMRA2454L	24"	54"	29"	121	23	\$830
MMRA2460L	24"	60"	29"	124	24	\$843
MMRA3048L	30"	48"	29"	127	25	\$843

½ modesty on returns may be specified at no upcharge.
For handles and pedestal lock, add MMUHL2...\$51 (Specify H3B-H14, see p. 43).
For full modesty panel upgrade, add MMFMP...\$59.

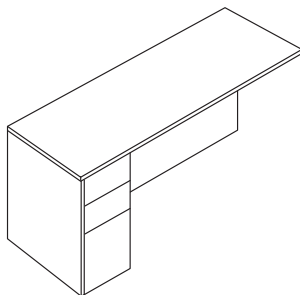

Return, Box/Box/File Pedestal (Full modesty), Left

Model#	Depth	Width	Height	Weight	Cube	Price
MMRC2036L	20"	36"	29"	130	13	\$975
MMRC2042L	20"	42"	29"	140	15	\$987
MMRC2048L	20"	48"	29"	150	17	\$1,002
MMRC2054L	20"	54"	29"	160	19	\$1,029
MMRC2436L	24"	36"	29"	140	15	\$1,064
MMRC2442L	24"	42"	29"	150	18	\$1,091
MMRC2448R	24"	48"	29"	160	20	\$1,102
MMRC2454R	24"	54"	29"	170	23	\$1,160
MMRC2460R	24"	60"	29"	180	24	\$1,173
MMRC3048R	30"	48"	29"	175	25	\$1,173

Full modesty standard. ½ modesty on returns may be specified at no upcharge.
For handles and pedestal lock, add MMUHL3...\$75 (Specify H3B-H14, see p. 43).

See available accessories and upgrades, pp. 49-54



Maverick Series

Returns

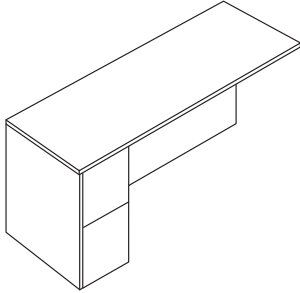

Return, File/File Pedestal (Full modesty), Left

Model#	Depth	Width	Height	Weight	Cube	Price
MMRD2036L	20"	36"	29"	130	13	\$935
MMRD2042L	20"	42"	29"	140	15	\$948
MMRD2048L	20"	48"	29"	150	17	\$963
MMRD2054L	20"	54"	29"	160	19	\$991
MMRD2436L	24"	36"	29"	140	15	\$1,026
MMRD2442L	24"	42"	29"	150	18	\$1,037
MMRD2448L	24"	48"	29"	160	20	\$1,065
MMRD2454L	24"	54"	29"	170	23	\$1,121
MMRD2460L	24"	60"	29"	180	24	\$1,133
MMRD3048L	30"	48"	29"	175	25	\$1,133

Full modesty standard. ½ modesty on returns may be specified at no upcharge.
For handles and pedestal lock, add MMUHL2...\$51 (Specify H3B-H14, see p. 43).

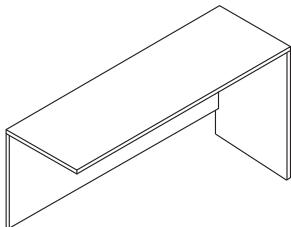

Return Shell (¾ modesty, Flush height), Right

Model#	Depth	Width	Height	Weight	Cube	Price
MMRN2036R	20"	36"	29"	60	13	\$322
MMRN2042R	20"	42"	29"	67	15	\$336
MMRN2048R	20"	48"	29"	73	17	\$382
MMRN2054R	20"	54"	29"	80	19	\$425
MMRN2442R	24"	42"	29"	67	18	\$459
MMRN2448R	24"	48"	29"	74	20	\$487
MMRN2454R	24"	54"	29"	80	23	\$521
MMRN3048R	30"	48"	29"	89	25	\$561

¾ modesty standard. ½ modesty on returns may be specified at no upcharge.
For full modesty panel upgrade, add MMFMP...\$59.

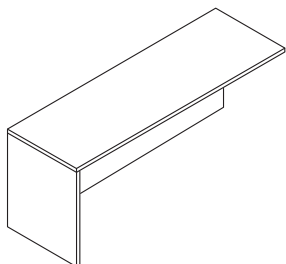

Return Shell (¾ modesty, Flush height), Left

Model#	Depth	Width	Height	Weight	Cube	Price
MMRN2036L	20"	36"	29"	60	13	\$322
MMRN2042L	20"	42"	29"	67	15	\$336
MMRN2048L	20"	48"	29"	73	17	\$382
MMRN2054L	20"	54"	29"	80	19	\$425
MMRN2442L	24"	42"	29"	67	18	\$459
MMRN2448L	24"	48"	29"	74	20	\$487
MMRN2454L	24"	54"	29"	80	23	\$521
MMRN3048L	30"	48"	29"	89	25	\$561

¾ modesty standard. ½ modesty on returns may be specified at no upcharge.
For full modesty panel upgrade, add MMFMP...\$59.

Maverick Series



Returns

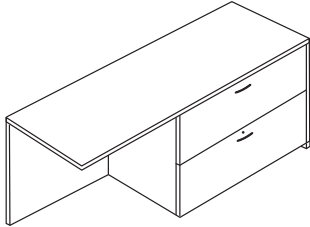

Return, 30" Lateral File (H3B handles, lock, full modesty), Right

Model#	Depth	Width	Height	Weight	Cube	Price
MMRLF2054R	20"	54"	29"	192	19	\$1,248
MMRLF2060R	20"	60"	29"	198	21	\$1,272
MMRLF2072R	20"	72"	29"	212	25	\$1,378
MMRLF2454R	24"	54"	29"	201	23	\$1,324
MMRLF2460R	24"	60"	29"	208	25	\$1,358
MMRLF2472R	24"	72"	29"	219	30	\$1,447

Specify H3B-H14, See p.43. For H30 handle, add \$56/each.

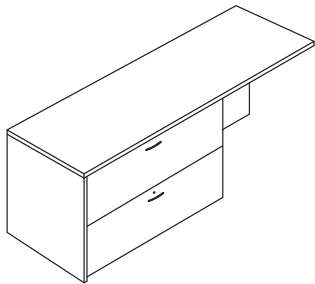

Return, 30" Lateral File (H3B handles, lock, full modesty), Left

Model#	Depth	Width	Height	Weight	Cube	Price
MMRLF2054L	20"	54"	29"	192	19	\$1,248
MMRLF2060L	20"	60"	29"	198	21	\$1,272
MMRLF2072L	20"	72"	29"	212	25	\$1,378
MMRLF2454L	24"	54"	29"	201	23	\$1,324
MMRLF2460L	24"	60"	29"	208	25	\$1,358
MMRLF2472L	24"	72"	29"	219	30	\$1,447

Specify H3B-H14, See p.43. For H30 handle, add \$56/each.

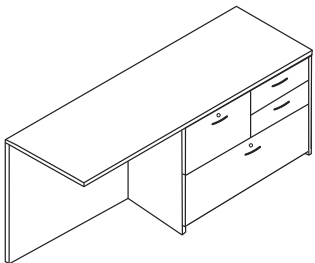

Return, 30" Personal Lateral File (H3B handles, locks, full modesty), Right

Model#	Depth	Width	Height	Weight	Cube	Price
MMRPLF2054R	20"	54"	29"	195	19	\$1,438
MMRPLF2060R	20"	60"	29"	201	23	\$1,488
MMRPLF2072R	20"	72"	29"	216	25	\$1,600
MMRPLF2454R	24"	54"	29"	205	23	\$1,453
MMRPLF2460R	24"	60"	29"	213	28	\$1,519
MMRPLF2472R	24"	72"	29"	223	30	\$1,651

Box drawers do not lock. Specify H3B-H14, See p.43.

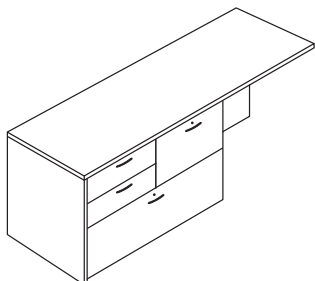

Return, 30" Personal Lateral File (H3B handles, locks, full modesty), Left

Model#	Depth	Width	Height	Weight	Cube	Price
MMRPLF2054L	20"	54"	29"	195	19	\$1,438
MMRPLF2060L	20"	60"	29"	201	23	\$1,488
MMRPLF2072L	20"	72"	29"	216	25	\$1,600
MMRPLF2454L	24"	54"	29"	205	23	\$1,453
MMRPLF2460L	24"	60"	29"	213	28	\$1,519
MMRPLF2472L	24"	72"	29"	223	30	\$1,651

Box drawers do not lock. Specify H3B-H14, See p.43.



Maverick Series

Credenzas

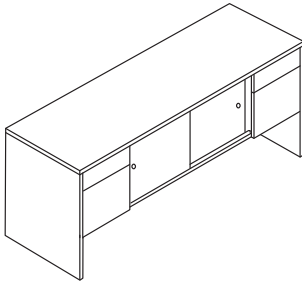

Credenza, Double Pedestal, Box/File Left and Right, Center Storage (Sliding doors)

	Model#	Depth	Width	Height	Weight	Cube	Price
	MMC2060 2	20"	60"	29"	230	21	\$1,008
	MMC2066 2	20"	66"	29"	240	23	\$1,193
	MMC2072 2	20"	72"	29"	250	25	\$1,206
	MMC2472 2	24"	72"	29"	270	30	\$1,282

Storage includes one adjustable 3/4" thick shelf. May be upgraded to hinged doors, add UPHD2...\$187.

For handles and pedestal lock, add MMUHL2...\$51 each pedestal (Specify H3B-H14, see p. 43).

NOTE: Ped lock is inside doors.

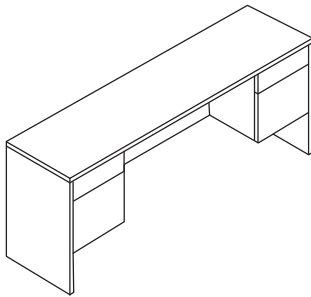

Credenza, Double Pedestal, Box/File Left and Right (Knee space, 3/4 modesty)

	Model#	Depth	Width	Height	Weight	Cube	Price
	MMC2060 3	20"	60"	29"	196	21	\$931
	MMC2066 3	20"	66"	29"	205	23	\$1,125
	MMC2072 3	20"	72"	29"	210	25	\$1,146
	MMC2472 3	24"	72"	29"	230	30	\$1,178

For full modesty panel upgrade, add MMFMP...\$59.

For handles and pedestal lock, add MMUHL2...\$51 each pedestal (Specify H3B-H14, see p. 43).

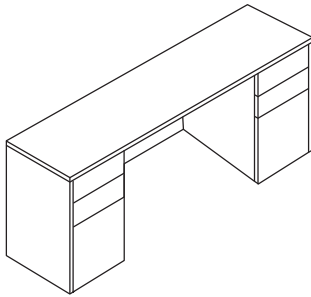

Credenza, Double Pedestal, Box/Box/File Left and Right (Knee space, full modesty)

	Model#	Depth	Width	Height	Weight	Cube	Price
	MMCC2060 3	20"	60"	29"	245	21	\$1,262
	MMCC2066 3	20"	66"	29"	255	23	\$1,455
	MMCC2072 3	20"	72"	29"	265	25	\$1,474
	MMCC2472 3	24"	72"	29"	290	30	\$1,508

For handles and pedestal lock, add MMUHL3...\$75 each pedestal (Specify H3B-H14, see p. 43).

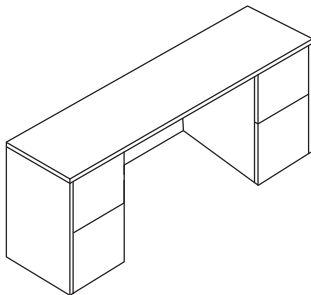

Credenza, Double Pedestal, File/File Left and Right (Knee space, full modesty)

	Model#	Depth	Width	Height	Weight	Cube	Price
	MMCD2060 3	20"	60"	29"	245	21	\$1,223
	MMCD2066 3	20"	66"	29"	255	23	\$1,417
	MMCD2072 3	20"	72"	29"	265	25	\$1,437
	MMCD2472 3	24"	72"	29"	290	30	\$1,469

For handles and pedestal lock, add MMUHL2...\$51 each pedestal (Specify H3B-H14, see p. 43).

Maverick Series



Credenzas

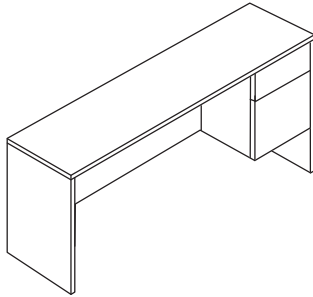

Credenza, Single Box/File Pedestal (¾ modesty), Right

Model#	Depth	Width	Height	Weight	Cube	Price
MMC2060 4R	20"	60"	29"	150	21	\$762
MMC2066 4R	20"	66"	29"	157	23	\$856
MMC2072 4R	20"	72"	29"	164	25	\$871
MMC2472 4R	24"	72"	29"	168	30	\$899

For full modesty panel upgrade, add MMFMP...\$59.

For handles and pedestal lock, add MMUHL2...\$51 each pedestal (Specify H3B-H14, see p. 43).

Credenza, Single Box/Box/File Pedestal (Knee space, full modesty), Right

Model#	Depth	Width	Height	Weight	Cube	Price
MMCC2060 4R	20"	60"	29"	185	21	\$1,079
MMCC2066 4R	20"	66"	29"	190	23	\$1,187
MMCC2072 4R	20"	72"	29"	200	25	\$1,201
MMCC2472 4R	24"	72"	29"	220	30	\$1,227

For handles and pedestal lock, add MMUHL3...\$75 (Specify H3B-H14, see p. 43).

Credenza, Single File/File Pedestal (Knee space, full modesty), Right

Model#	Depth	Width	Height	Weight	Cube	Price
MMCD2060 4R	20"	60"	29"	183	21	\$1,040
MMCD2066 4R	20"	66"	29"	190	23	\$1,147
MMCD2072 4R	20"	72"	29"	200	25	\$1,162
MMCD2472 4R	24"	72"	29"	220	30	\$1,190

For handles and pedestal lock, add MMUHL2...\$51 (Specify H3B-H14, see p. 43).

Credenza, Single Box/File Pedestal, (¾ modesty) Left

Model#	Depth	Width	Height	Weight	Cube	Price
MMC2060 4L	20"	60"	29"	150	21	\$762
MMC2066 4L	20"	66"	29"	157	23	\$856
MMC2072 4L	20"	72"	29"	164	25	\$871
MMC2472 4L	24"	72"	29"	168	30	\$899

For full modesty panel upgrade, add MMFMP...\$59.

For handles and pedestal lock, add MMUHL2...\$51 each pedestal (Specify H3B-H14, see p. 43).

Credenza, Single Box/Box/File Pedestal (Knee space, full modesty), Left

Model#	Depth	Width	Height	Weight	Cube	Price
MMCC2060 4L	20"	60"	29"	185	21	\$1,079
MMCC2066 4L	20"	66"	29"	190	23	\$1,187
MMCC2072 4L	20"	72"	29"	200	25	\$1,201
MMCC2472 4L	24"	72"	29"	220	30	\$1,227

For handles and pedestal lock, add MMUHL3...\$75 (Specify H3B-H14, see p. 43).

Credenza, Single File/File Pedestal (Knee space, full modesty), Left

Model#	Depth	Width	Height	Weight	Cube	Price
MMCD2060 4L	20"	60"	29"	183	21	\$1,040
MMCD2066 4L	20"	66"	29"	190	23	\$1,147
MMCD2072 4L	20"	72"	29"	200	25	\$1,162
MMCD2472 4L	24"	72"	29"	220	30	\$1,190

For handles and pedestal lock, add MMUHL2...\$51 (Specify H3B-H14, see p. 43).

See available accessories and upgrades, pp. 49-54

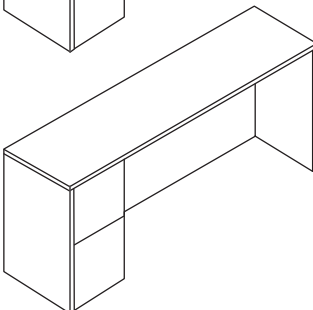
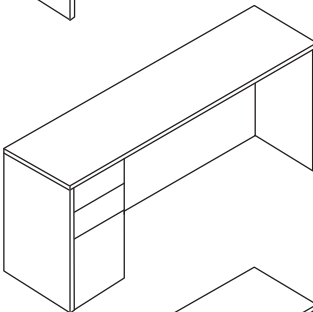
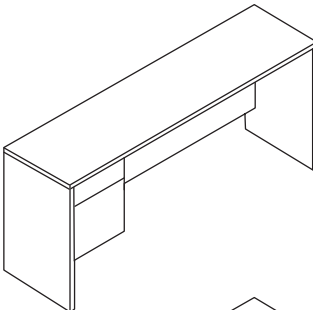
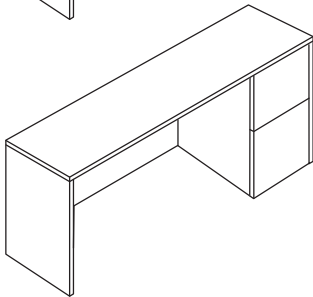
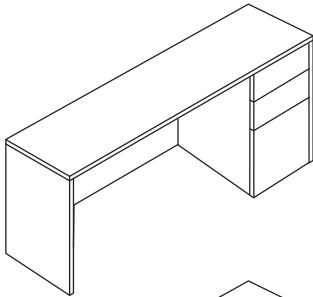



Maverick Series

Credenzas

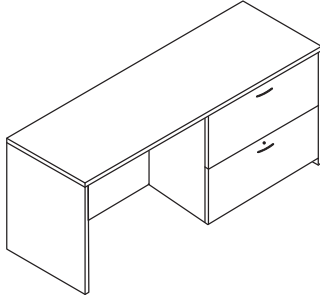

Credenza, 36" Lateral File Pedestal (H3B handles, lock, full modesty), Right

Model#	Depth	Width	Height	Weight	Cube	Price
MMC2066 5R	20"	66"	29"	223	23	\$1,378
MMC2072 5R	20"	72"	29"	230	25	\$1,391
MMC2472 5R	24"	72"	29"	270	30	\$1,459

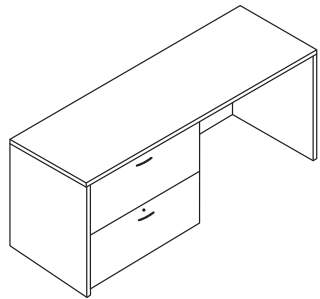

Credenza, 36" Lateral File Pedestal (H3B handles, lock, full modesty), Left

Model#	Depth	Width	Height	Weight	Cube	Price
MMC2066 5L	20"	66"	29"	223	23	\$1,378
MMC2072 5L	20"	72"	29"	230	25	\$1,391
MMC2472 5L	24"	72"	29"	270	30	\$1,459

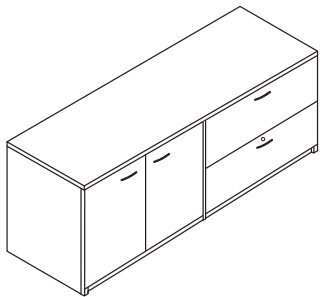

Credenza, Hinged Door Cabinet Left and Lateral File (H3B handles, lock), Right

Model#	Depth	Width	Height	Weight	Cube	Price
MMC2072 9FP	20"	72"	29"	270	30	\$1,701
MMC2472 9FP	24"	72"	29"	290	30	\$1,748

Optional face locks available for hinged doors, add MMFL...\$71.

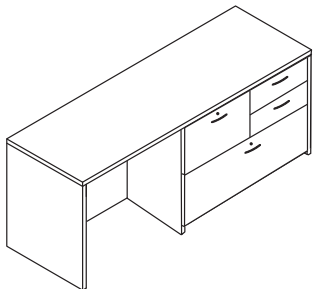

Credenza, 31" Personal Lateral File Pedestal (H3B handles, locks, full modesty), Right

Model#	Depth	Width	Height	Weight	Cube	Price
MMC2066 6R	20"	66"	29"	230	26	\$1,570
MMC2072 6R	20"	72"	29"	236	28	\$1,590
MMC2472 6R	24"	72"	29"	260	30	\$1,657

Box drawers do not lock.

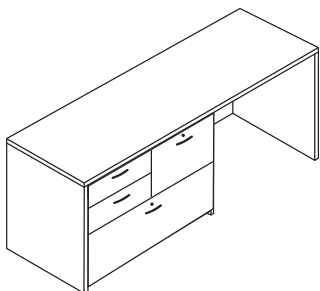

Credenza, 31" Personal Lateral File Pedestal (H3B handles, locks, full modesty), Left

Model#	Depth	Width	Height	Weight	Cube	Price
MMC2066 6L	20"	66"	29"	230	26	\$1,570
MMC2072 6L	20"	72"	29"	236	28	\$1,590
MMC2472 6L	24"	72"	29"	260	30	\$1,657

Box drawers do not lock.

Maverick Series



Credenzas

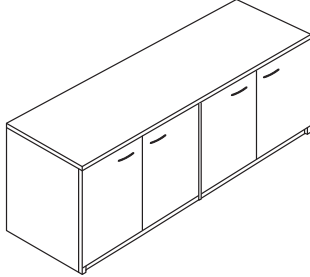

Credenza, Full Storage (H3B handles, hinged doors, two adjustable shelves)

Model#	Depth	Width	Height	Weight	Cube	Price
MMC2060 1FP	20"	60"	29"	220	21	\$1,447
MMC2066 1FP	20"	66"	29"	240	23	\$1,570
MMC2072 1FP	20"	72"	29"	260	25	\$1,590
MMC2472 1FP	24"	72"	29"	295	30	\$1,728

Shelves are $\frac{3}{4}$ " thick. Optional face door locks available (two locks required), add MMFL...\$71 each. Specify H3B-H14, See p.43.

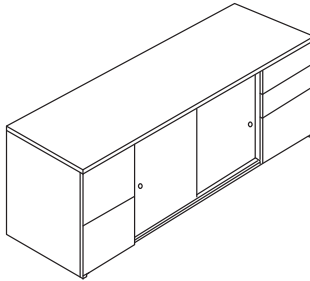

Credenza, Full Pedestal F/F Left and B/B/F Right, Center Storage (Sliding doors)

Model#	Depth	Width	Height	Weight	Cube	Price
MMC2060 2FP	20"	60"	29"	270	21	\$1,570
MMC2066 2FP	20"	66"	29"	300	23	\$1,754
MMC2072 2FP	20"	72"	29"	330	25	\$1,770
MMC2472 2FP	24"	72"	29"	360	30	\$1,816

Storage includes one adjustable $\frac{3}{4}$ " thick shelf. May be upgraded to hinged doors, add MMUPHD2...\$187. For handles and pedestal lock, add MMUHL2 and MMUHL3...\$110 (Specify handle H3B-H14, see p. 43). NOTE: Ped lock is inside doors.

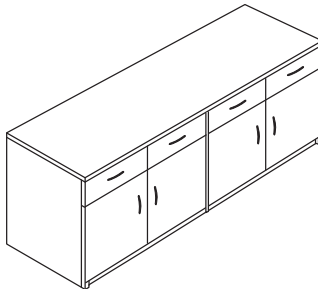

Credenza, Buffet (4 box drawers, full hinged doors, H3B handles)

Model#	Depth	Width	Height	Weight	Cube	Price
MMHDBC2036	20"	36"	36"	220	15	\$1,048
MMHDBC2436	24"	36"	36"	240	18	\$1,150
MMHDBC2072	20"	72"	36"	260	30	\$2,169
MMHDBC2472	24"	72"	36"	290	36	\$2,264

Storage includes one adjustable $\frac{3}{4}$ " thick shelf. Specify H3B-H14, See p.43. Optional face locks available (two locks required for doors), add MMFL...\$71 each.

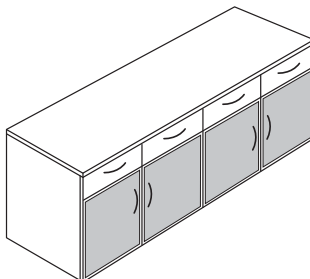

Credenza, Buffet (4 box drawers, full hinged glass doors, H3B handles)

Model#	Depth	Width	Height	Weight	Cube	Price
MMHDBC2072G	20"	72"	36"	240	18	\$2,955
MMHDBC2472G	24"	72"	36"	290	36	\$3,048

Storage includes one adjustable $\frac{3}{4}$ " thick shelf. Locks N/A for glass doors. Specify H3B-H14, See p.43. Optional face locks available for box drawers, add MMFL...\$71 each.



Maverick Series

CompuCorner Credenzas

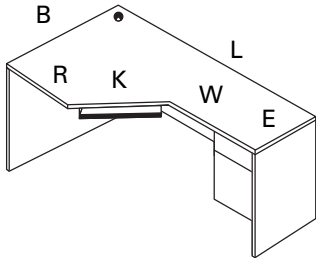

Computer Corner, Box/File Pedestal (3/4 modesty), Right



Model#	(L)	(B)	(E)	(K)	(R)	(W)	Weight	Cube	Price
MMCD66 4R	66"	36"	24"	21"	24"	24"	229	42	\$1,021
MMCD72 3R	72"	36"	20"	24"	20"	33"	249	45	\$1,084
MMCD72 4R	72"	36"	24"	21"	24"	30"	249	45	\$974
MMCD72 7R	72"	36"	24"	23"	20"	32"	285	45	\$1,068
MMCD72 8R	72"	42"	24"	24"	24"	33"	285	53	\$1,310

For full modesty panel upgrade, add MMFMP...\$59. Keyboard tray, worksurface black grommet standard. Upgrade grommet cover to silver, N/C. For handles and pedestal lock, add MMUHL2...\$51 (Specify H3B-H14, see p. 43).

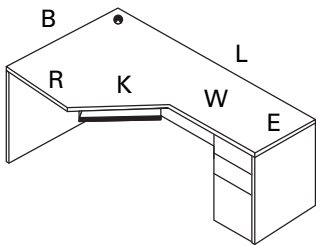

Computer Corner, Box/Box/File Pedestal (Full modesty), Right



Model#	(L)	(B)	(E)	(K)	(R)	(W)	Weight	Cube	Price
MMCD66C 4R	66"	36"	24"	21"	24"	24"	245	42	\$1,351
MMCD72C 3R	72"	36"	20"	24"	20"	33"	265	45	\$1,412
MMCD72C 4R	72"	36"	24"	21"	24"	30"	265	45	\$1,303
MMCD72C 7R	72"	36"	24"	23"	20"	32"	300	45	\$1,400
MMCD72C 8R	72"	42"	24"	24"	24"	33"	300	53	\$1,640

Keyboard tray, worksurface black grommet standard. Upgrade grommet cover to silver, N/C. For handles and pedestal lock, add MMUHL3...\$75. (Specify H3B-H14, see p. 43).

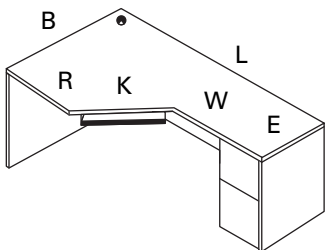

Computer Corner, File/File Pedestal (Full modesty), Right



Model#	(L)	(B)	(E)	(K)	(R)	(W)	Weight	Cube	Price
MMCD66D 4R	66"	36"	24"	21"	24"	24"	245	42	\$1,264
MMCD72D 3R	72"	36"	20"	24"	20"	33"	265	45	\$1,326
MMCD72D 4R	72"	36"	24"	21"	24"	30"	265	45	\$1,264
MMCD72D 7R	72"	36"	24"	23"	20"	32"	300	45	\$1,360
MMCD72D 8R	72"	42"	24"	24"	24"	33"	300	53	\$1,601

Keyboard tray, worksurface black grommet standard. Upgrade grommet cover to silver, N/C. For handles and pedestal lock, add MMUHL2...\$51. (Specify H3B-H14, see p. 43).

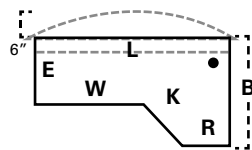

- "L" Length along approach edge
- "B" Back end panel (Fan top adds 6")
- "E" End panel
- "K" Keyboard space
- "R" Return size to attach
- "W" Workarea (kbrd to end)

Maverick Series



CompuCorner Credenzas

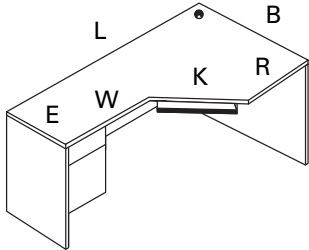

Computer Corner, Box/File Pedestal, Left (¾ modesty)

Model#	(L)	(B)	(E)	(K)	(R)	(W)	Weight	Cube	Price
MMCD66 4L	66"	36"	24"	21"	24"	24"	229	42	\$1,021
MMCD72 3L	72"	36"	20"	24"	20"	33"	249	45	\$1,084
MMCD72 4L	72"	36"	24"	21"	24"	30"	249	45	\$974
MMCD72 7L	72"	36"	24"	23"	20"	32"	285	45	\$1,068
MMCD72 8L	72"	42"	24"	24"	24"	33"	285	53	\$1,310

For full modesty panel upgrade, add MMFMP...\$59. Keyboard tray and worksurface black grommet standard. Upgrade grommet cover to silver, N/C. For handles and pedestal lock, add MMUHL2...\$51 (Specify H3B-H14, see p. 43).

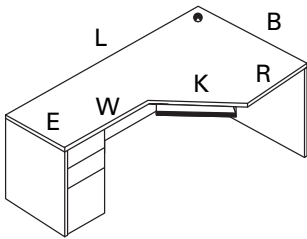

Computer Corner, Box/Box/File Pedestal (Full modesty), Left

Model#	(L)	(B)	(E)	(K)	(R)	(W)	Weight	Cube	Price
MMCD66C 4L	66"	36"	24"	21"	24"	24"	245	42	\$1,351
MMCD72C 3L	72"	36"	20"	24"	20"	33"	265	45	\$1,412
MMCD72C 4L	72"	36"	24"	21"	24"	30"	265	45	\$1,303
MMCD72C 7L	72"	36"	24"	23"	20"	32"	300	45	\$1,400
MMCD72C 8L	72"	42"	24"	24"	24"	33"	300	53	\$1,640

Keyboard tray and worksurface black grommet standard. Upgrade grommet cover to silver, N/C. For handles and pedestal lock, add MMUHL3...\$75. (Specify H3B-H14, see p. 43).

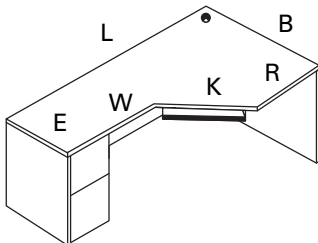

Computer Corner, File/File Pedestal (Full modesty), Left

Model#	(L)	(B)	(E)	(K)	(R)	(W)	Weight	Cube	Price
MMCD66D 4L	66"	36"	24"	21"	24"	24"	245	42	\$1,264
MMCD72D 3L	72"	36"	20"	24"	20"	33"	265	45	\$1,326
MMCD72D 4L	72"	36"	24"	21"	24"	30"	265	45	\$1,264
MMCD72D 7L	72"	36"	24"	23"	20"	32"	300	45	\$1,360
MMCD72D 8L	72"	42"	24"	24"	24"	33"	300	53	\$1,601

Keyboard tray and worksurface black grommet standard. Upgrade grommet cover to silver, N/C. For handles and pedestal lock, add MMUHL2...\$51. (Specify H3B-H14, see p. 43).

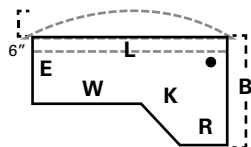

"L" Length along approach edge
 "B" Back end panel (Fan top adds 6")
 "E" End panel
 "K" Keyboard space
 "R" Return size to attach
 "W" Workarea (kbrd to end)



Maverick Series

CompuCorner Credenzas

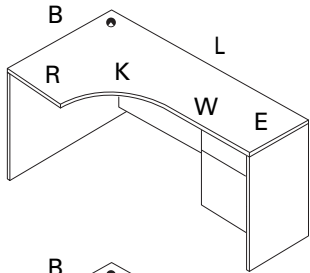

Computer Corner, Curved, $\frac{3}{4}$ Box/File Pedestal ($\frac{3}{4}$ modesty), Right

Model#	(L)	(B)	(E)	(K)	(R)	(W)	Weight	Cube	Price
MMCDQ72 4R	72"	36"	24"	21"	24"	30"	239	45	\$974

No keyboard tray. Worksurface black grommet standard. Upgrade grommet cover to silver, N/C.
For handles and pedestal lock, add MMUHL2...\$51. (Specify H3B-H14, see p. 43).
For full modesty panel upgrade, add MMFMP...\$59.

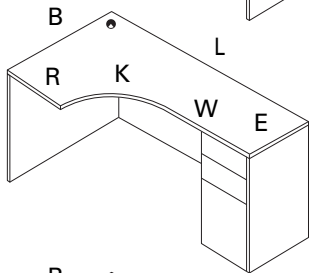

Computer Corner, Curved, Box/Box/File Pedestal (Full modesty), Right

Model#	(L)	(B)	(E)	(K)	(R)	(W)	Weight	Cube	Price
MMCDQ72C 4R	72"	36"	24"	21"	24"	30"	254	45	\$1,303

No keyboard tray. Worksurface black grommet standard. Upgrade grommet cover to silver, N/C.
For handles and pedestal lock, add MMUHL3...\$75. (Specify H3B-H14, see p. 43).

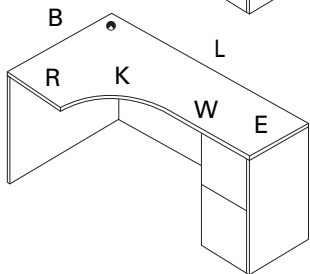

Computer Corner, Curved, File/File Pedestal (Full modesty), Right

Model#	(L)	(B)	(E)	(K)	(R)	(W)	Weight	Cube	Price
MMCDQ72D 4R	72"	36"	24"	21"	24"	30"	254	45	\$1,265

No keyboard tray. Worksurface black grommet standard. Upgrade grommet cover to silver, N/C.
For handles and pedestal lock, add MMUHL2...\$51. (Specify H3B-H14, see p. 43).

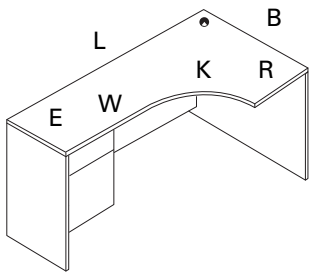

Computer Corner, Curved, $\frac{3}{4}$ Box/File Pedestal ($\frac{3}{4}$ modesty), Left

Model#	(L)	(B)	(E)	(K)	(R)	(W)	Weight	Cube	Price
MMCDQ72 4L	72"	36"	24"	21"	24"	30"	239	45	\$974

No keyboard tray. Worksurface black grommet standard. Upgrade grommet cover to silver, N/C.
For handles and pedestal lock, add MMUHL2...\$51. (Specify H3B-H14, see p. 43).
For full modesty panel upgrade, add MMFMP...\$59.

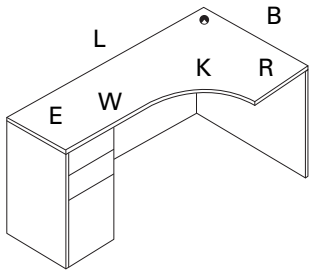

Computer Corner, Curved, Box/Box/File Pedestal (Full modesty), Left

Model#	(L)	(B)	(E)	(K)	(R)	(W)	Weight	Cube	Price
MMCDQ72C 4L	72"	36"	24"	21"	24"	30"	254	45	\$1,303

No keyboard tray. Worksurface black grommet standard. Upgrade grommet cover to silver, N/C.
For handles and pedestal lock, add MMUHL3...\$75. (Specify H3B-H14, see p. 43).

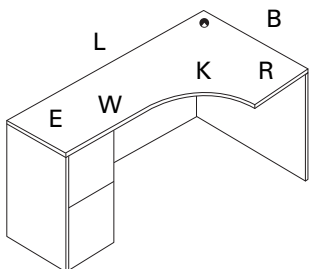

Computer Corner, Curved, File/File Pedestal (Full modesty), Left

Model#	(L)	(B)	(E)	(K)	(R)	(W)	Weight	Cube	Price
MMCDQ72D 4L	72"	36"	24"	21"	24"	30"	254	45	\$1,265

No keyboard tray. Worksurface black grommet standard. Upgrade grommet cover to silver, N/C.
For handles and pedestal lock, add MMUHL2...\$51. (Specify H3B-H14, see p. 43).

Maverick Series



CompuCorner Credenzas

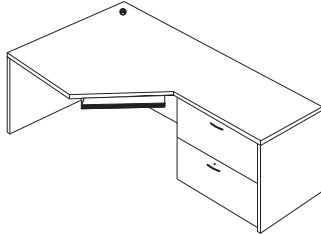

Computer Corner, 30" Lateral File (H3B handles, lock, full modesty), Right

Model#	(L)	(B)	(E)	(K)	(R)	(W)	Weight	Cube	Price
MMCD72LF 3R	72"	36"	20"	24"	20"	33"	249	45	\$1,447
MMCD72LF 4R	72"	36"	24"	21"	24"	30"	265	45	\$1,527
MMCD78LF 5R	78"	42"	24"	24"	24"	36"	275	57	\$1,714
MMCD78LF 6R	78"	48"	30"	24"	30"	31"	249	65	\$1,996

Keyboard tray and worksurface black grommet standard. Specify H3B-H14, see p. 43. For H30 handle...add \$56. Upgrade grommet cover to silver, N/C.

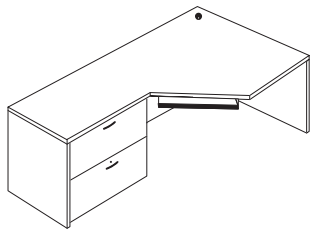

Computer Corner, 30" Lateral File (H3B handles, lock, full modesty), Left

Model#	(L)	(B)	(E)	(K)	(R)	(W)	Weight	Cube	Price
MMCD72LF 3L	72"	36"	20"	24"	20"	33"	249	45	\$1,447
MMCD72LF 4L	72"	36"	24"	21"	24"	30"	265	45	\$1,527
MMCD78LF 5L	78"	42"	24"	24"	24"	36"	275	57	\$1,714
MMCD78LF 6L	78"	48"	30"	24"	30"	31"	249	65	\$1,996

Keyboard tray and worksurface black grommet standard. Specify H3B-H14, see p. 43. For H30 handle...add \$56. Upgrade grommet cover to silver, N/C.

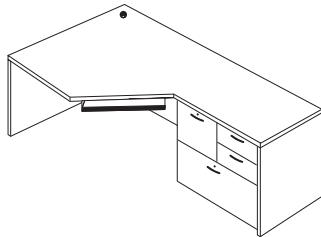

Computer Corner, 30" Personal Lateral File, Right (H3B handles, locks, full modesty)

Model#	(L)	(B)	(E)	(K)	(R)	(W)	Weight	Cube	Price
MMCD72PLF 3R	72"	36"	20"	24"	20"	33"	249	45	\$1,605
MMCD72PLF 4R	72"	36"	24"	21"	24"	30"	265	45	\$1,647
MMCD78PLF 5R	78"	42"	24"	24"	24"	36"	275	57	\$1,728
MMCD78PLF 6R	78"	48"	30"	24"	30"	31"	249	65	\$2,106

Keyboard tray and worksurface black grommet standard. Box drawers do not lock. Specify H3B-H14, see p. 43. For H30 handle...add \$56. Upgrade grommet cover to silver, N/C.

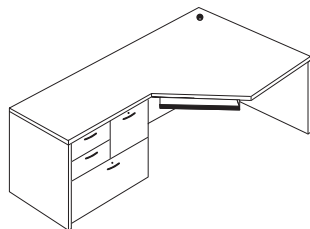

Computer Corner, 30" Personal Lateral File, Left (H3B handles, locks, full modesty)

Model#	(L)	(B)	(E)	(K)	(R)	(W)	Weight	Cube	Price
MMCD72PLF 3L	72"	36"	20"	24"	20"	33"	249	45	\$1,605
MMCD72PLF 4L	72"	36"	24"	21"	24"	30"	265	45	\$1,647
MMCD78PLF 5L	78"	42"	24"	24"	24"	36"	275	57	\$1,728
MMCD78PLF 6L	78"	48"	30"	24"	30"	31"	249	65	\$2,106

Keyboard tray and worksurface black grommet standard. Box drawers do not lock. Specify H3B-H14, see p. 43. For H30 handle...add \$56. Upgrade grommet cover to silver, N/C.

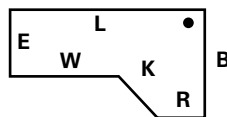

"L" Length along approach edge

"B" Back end panel

"E" End panel

"K" Keyboard space

"R" Return size to attach

"W" Workarea (kbrd to end)



Maverick Series

CompuCorner Credenzas

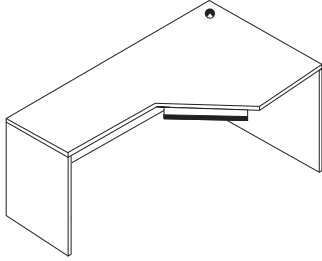

Computer Corner Shell (3/4 modesty), For Right Return

Model#	(L)	(B)	(E)	(K)	(R)	(W)	Weight	Cube	Price
MMCDN60 2R	60"	30"	20"	21"	20"	21"	184	32	\$719
MMCDN72 3R	72"	36"	20"	24"	20"	33"	213	45	\$843
MMCDN72 4R	72"	36"	24"	21"	24"	30"	213	45	\$871
MMCDN78 5R	78"	42"	24"	24"	24"	37"	234	57	\$1,206
MMCDN78 6R	78"	48"	30"	24"	30"	31"	234	65	\$1,378

Keyboard tray and worksurface black grommet standard. Upgrade grommet cover to silver, N/C.
For full modesty panel upgrade, add MMFMP...\$59.

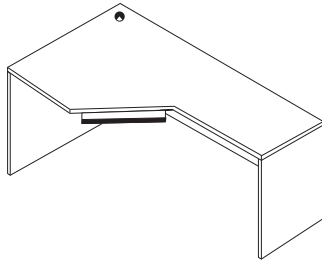

Computer Corner Shell (3/4 modesty), For Left Return

Model#	(L)	(B)	(E)	(K)	(R)	(W)	Weight	Cube	Price
MMCDN60 2L	60"	30"	20"	21"	20"	21"	184	32	\$719
MMCDN72 3L	72"	36"	20"	24"	20"	33"	213	45	\$843
MMCDN72 4L	72"	36"	24"	21"	24"	30"	213	45	\$871
MMCDN78 5L	78"	42"	24"	24"	24"	37"	234	57	\$1,206
MMCDN78 6L	78"	48"	30"	24"	30"	31"	234	65	\$1,378

Keyboard tray and worksurface black grommet standard. Upgrade grommet cover to silver, N/C.
For full modesty panel upgrade, add MMFMP...\$59.

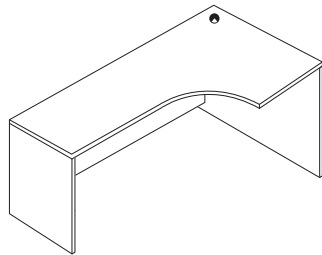

Computer Corner Shell, Curved (3/4 modesty), For Right Return

Model#	(L)	(B)	(E)	(K)	(R)	(W)	Weight	Cube	Price
MMCDNQ72 4R	72"	36"	24"	21"	24"	30"	213	45	\$871

Worksurface black grommet standard. No keyboard tray. Upgrade grommet cover to silver, N/C.
For full modesty panel upgrade, add MMFMP...\$59.

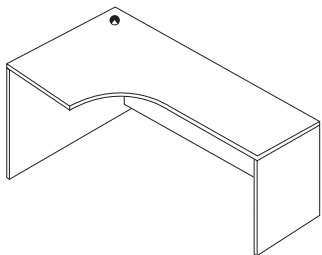

Computer Corner Shell, Curved, For Left Return (3/4 modesty)

Model#	(L)	(B)	(E)	(K)	(R)	(W)	Weight	Cube	Price
MMCDNQ72 4L	72"	36"	24"	21"	24"	30"	213	45	\$871

Worksurface black grommet standard. No keyboard tray. Upgrade grommet cover to silver, N/C.
For full modesty panel upgrade, add MMFMP...\$59.

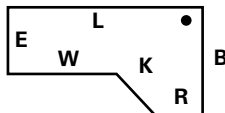

- "L" Length along approach edge
- "B" Back end panel
- "E" End panel
- "K" Keyboard space
- "R" Return size to attach
- "W" Workarea (kbrd to end)

Maverick Series



Hutches (For upgrades see p. 42)

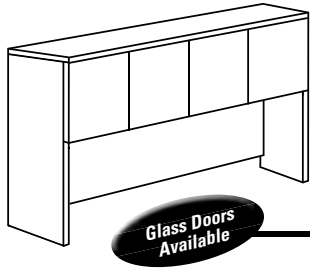

Hutch, with Doors (19" below doors)

Model#	Depth	Width	Height	Weight	Cube	Price
MMH48 WD	14"	48"	36"	130	14	\$932
MMH60 WD	14"	60"	36"	155	18	\$1,008
MMH66 WD	14"	66"	36"	167	20	\$1,097
MMH72 WD	14"	72"	36"	179	21	\$1,125
MMH72 WG	14"	72"	36"	179	21	\$1,601

Optional face locks available (two locks required), add MMFL...\$71 each. Glass doors do NOT lock. May be upgraded to 42" height, add MMUHH...\$162. Add tasklights, fascia and tackboards, see p. 42. Ends are 3/4" thick; doors overlay legs but are inset to the 1"-thick top. Add 25% for HPL White Gloss doors with Brushed metal edge banding.

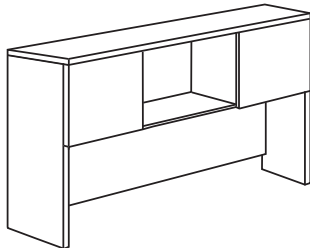

Hutch, Two Doors, Center Opening (19" below doors)

Model#	Depth	Width	Height	Weight	Cube	Price
MMH60 W2D	14"	60"	36"	140	18	\$911
MMH66 W2D	14"	66"	36"	152	20	\$961
MMH72 W2D	14"	72"	36"	164	21	\$1,008

Optional face locks available (two locks required), add MMFL...\$71 each. Doors are same width as open space. May be upgraded to 42" height, add MMUHH...\$162. Add tasklights, fascia and tackboards, see p. 43. Ends are 3/4" thick; doors overlay legs but are inset to the 1"-thick top. Add 25% for HPL White Gloss doors with Brushed metal edge banding.

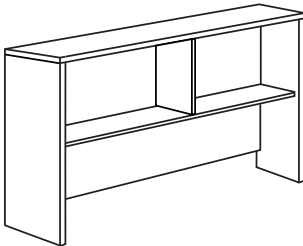

Hutch, No Doors (20" below shelf)

Model#	Depth	Width	Height	Weight	Cube	Price
MMH48 ND	14"	48"	36"	115	14	\$672
MMH60 ND	14"	60"	36"	135	18	\$699
MMH66 ND	14"	66"	36"	148	20	\$762
MMH72 ND	14"	72"	36"	160	21	\$843

May be upgraded to 42" height, add MMUHH...\$162. Add tasklights, fascia and tackboards, see p. 42. Ends are 3/4" thick; doors overlay legs but are inset to the 1"-thick top.



Bookcase Hutch (One adjustable shelf, One fixed shelf, 1"-thick shelves)

Model#	# Shelves	Depth	Width	Height	Weight	Cube	Price
MMBCH	2	14"	36"	36"	72	11	\$411

May be upgraded to 42" height, add MMUHH...\$162. Width coordinates with lateral files and utility cabinets. Ends are 3/4" thick; legs are inset to the 1"-thick top, see p. 42.

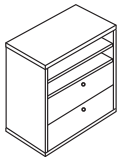

Paper Manager Mail Sorter (One fixed shelf, two drawers, set-on-surface, flat PVC edges)

Model#	Depth	Width	Height	Weight	Cube	Price
MM MS111717 2DR	11"	17"	17"	10	1.4	\$435

Freestanding for desktop placement.

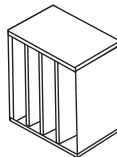

Vertical File Holder (Three fixed shelves, set-on-surface, flat PVC edges)

Model#	Depth	Width	Height	Weight	Cube	Price
MM VFH121414	12"	14"	14"	10	1.4	\$257

Freestanding for desktop placement.

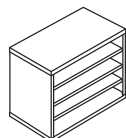

Paper Manager Mail Sorter (Three adjustable shelves, set-on-surface, flat PVC edges)

Model#	Depth	Width	Height	Weight	Cube	Price
MM MS121414	12"	14"	14"	10	1.4	\$279

Freestanding for desktop placement.



Maverick Series

Cabinets

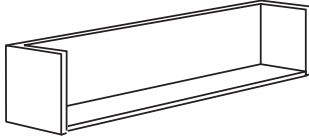

Overhead Wall-Mounted Cabinet, No Doors (Limited weight capacity)

Model#	Depth	Width	Height	Weight	Cube	Price
MMCFOHA48	14 3/4"	48"	14"	65	6	\$561
MMCFOHA60	14 3/4"	60"	14"	75	8	\$644

Limited weight capacity. Requires professional installation and must be mounted to wall stud. Weight 125lbs. @ capacity.

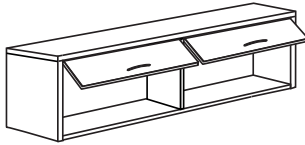

Overhead Wall-Mounted Cabinet With Flip or Hinged Doors (Limited weight capacity, H3B handles)

Model#	Depth	Width	Height	# of Doors	Weight	Cube	Price
MMCFOHB48	14 3/4"	48"	16"	2	110	7	\$975
MMCFOHB60	14 3/4"	60"	16"	2	120	9	\$1,050
MMCFOHD36	14 3/4"	36"	16"	2	110	7	\$793
MMCFOHD48	14 3/4"	48"	16"	4	120	9	\$1,159
MMCFOHD60	14 3/4"	60"	16"	4	120	9	\$1,233

Optional locks are available, two locks required, add MMFL...\$71 each for flip doors and 4-doors. Limited weight capacity. Requires professional installation and must be mounted to wall stud. Weight 125lbs. @ capacity.

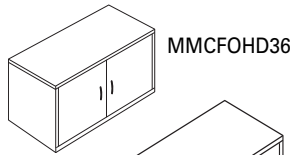

MMCFOHD36

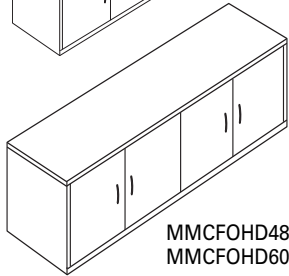
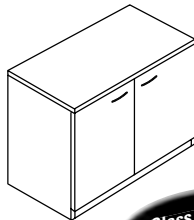
MMCFOHD48
MMCFOHD60

Glass Doors Available

Hinged Door Utility Cabinet (H3B handle, one 3/4"-thick adjustable shelf)

Model#	Depth	Width	Height	Weight	Cube	Price
*MMHDC2036	20"	36"	29"	115	13	\$719
MMHDC2042	20"	42"	29"	165	15	\$762
*MMHDC2436	24"	36"	29"	175	15	\$830
MMHDC2442	24"	42"	29"	180	18	\$899
MMHDC2436G	24"	36"	29"	175	18	\$1,122

Optional lock available, add MMFL...\$71. Width coordinates with bookcase hutch. Glass doors do NOT lock.

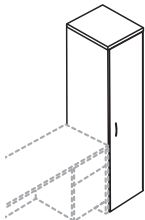

Single Storage Cabinet, Right (H3B handle, three adjustable 3/4"-thick shelves)

Model#	Depth	Width	Height	Weight	Cube	Price
MMSTS1665R	20"	16"	65"	185	12	\$899

Optional lock available, add MMFL...\$71. Add 25% for HPL White Gloss doors with Brushed metal edge banding. Upgrade to H3S handles...N/C. Add \$56 List for H30 Handle.

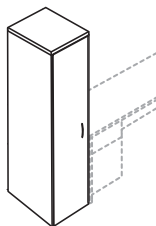

Single Storage Cabinet, Left (H3B handle, three adjustable 3/4"-thick shelves)

Model#	Depth	Width	Height	Weight	Cube	Price
MMSTS1665L	20"	16"	65"	185	12	\$899

Optional lock available, add MMFL...\$71 Add 25% for HPL White Gloss doors with Brushed metal edge banding. Upgrade to H3S handles...N/C. Add \$56 List for H30 Handle.

Maverick Series



Cabinets, Bookcases

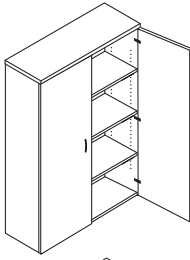

Double Storage Cabinet (H3B handles, 3/4" -thick adjustable shelves)

Model#	# Shelves	Depth	Width	Height	Weight	Cube	Price
MMST3642	2	20"	36"	42"	208	18	\$974
MMST3665	3	20"	36"	65"	290	27	\$1,221
MMST3672	4	20"	36"	72"	370	30	\$1,391

Optional lock available, add MMFL...\$71 Add 25% for HPL White Gloss doors with Brushed metal edge banding. Upgrade to H3S handles...N/C. Add \$56/ea. List for H30 Handle.

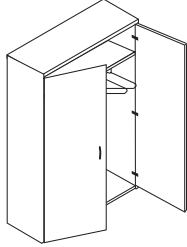

Wardrobe Cabinet (H3B handles, coat rack, one fixed shelf)

Model#	Depth	Width	Height	Weight	Cube	Price
MMWC3665	24"	36"	65"	309	33	\$1,221
MMWC3672	24"	36"	72"	325	36	\$1,391

Optional lock available, add MMFL...\$71. Add 25% for HPL White Gloss doors with Brushed metal edge banding. For H30 Handle, add...\$56 each.

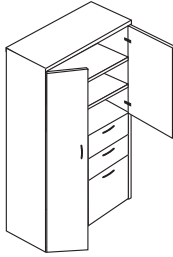

Personal Storage Cabinet

(H3B handles on doors and box/box/file pedestal, 2 adjustable shelves)

Model#	Depth	Width	Height	Weight	Cube	Price
MMWCP2465	24"	24"	65"	309	22	\$1,832
MMWCP2472	24"	24"	72"	325	24	\$1,982

Coat rack in long compartment. Optional face lock available (two locks required for doors), add MMFL...\$71 each. For pedestal lock (inside door), add MMPL...\$71. Add 25% for HPL White Gloss doors with Brushed metal edge banding.

Bookcases

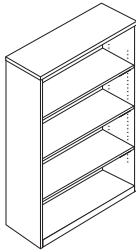

Bookcase (1" -thick adjustable shelves)

Model#	# Shelves	Depth	Width	Height	Weight	Cube	Price
MMBC3630	1	12"	36"	29"	61	18	\$398
MMBC3648	2	12"	36"	48"	86	12	\$535
MMBC3660	3	12"	36"	60"	107	15	\$644
MMBC3665	3	12"	36"	65"	111	17	\$672
MMBC3672	4	12"	36"	72"	128	18	\$699
MMBC3684	5	12"	36"	84"	137	21	\$871

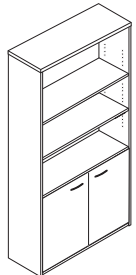

Bookcase with Storage Cabinet (H3B handles, 1" -thick adjustable shelves)

Model#	# Shelves	Depth	Width	Height	Weight	Cube	Price
MMBCD3660	2	14"	36"	60"	135	18	\$1,084
MMBCD3672	3	14"	36"	72"	145	21	\$1,125
MMBCD3684	4	14"	36"	84"	155	25	\$1,296

Optional lock available, add MMFL...\$71. Add 25% for HPL White Gloss doors with Brushed metal edge banding.

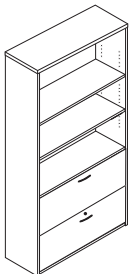

Bookcase with 36" Wide Lateral File (H3B handles, 1" -thick adjustable shelves, lock)

Model#	# Shelves	Depth	Width	Height	Weight	Cube	Price
MMBCLF3660	1	20"	36"	60"	224	25	\$1,482
MMBCLF3672	2	20"	36"	72"	260	30	\$1,557
MMBCLF3684	3	20"	36"	84"	281	35	\$1,714

For H30 Handle, add...\$56 each.

For handle selection...no charge. Specify from H5-H14, see pp. 50. See available accessories and upgrades, pp. 50-54.



Maverick Series

Bookcases

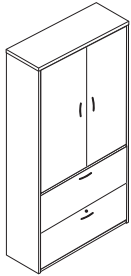

Bookcase with 36" Wide Lateral File & Doors (H3B handles, 1"-thick adjustable shelves, lock)

Model#	# Shelves	Depth	Width	Height	Weight	Cube	Price
MMBCLF3672WD	2	20"	36"	72"	300	30	\$1,885
MMBCLF3684WD	3	20"	36"	84"	331	35	\$2,104

Add 25% for HPL White Gloss doors with Brushed metal edge banding.
For H30 Handle, add...\$56 each.

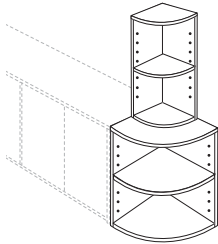

Bookcase, Corner, Right (Order separately, 1"-thick adjustable shelves)

Model#	# Shelves	Depth	Width	Height	Weight	Cube	Price
MMBCC1436R	1	14"	14"	36"	37	4	\$363
MMBCC1442R	2	14"	14"	42"	40	5	\$459
MMBCC2030R	1	20"	20"	29"	58	7	\$473
MMBCC2430R	1	24"	24"	29"	65	8	\$589
MMBCC2065R	3	20"	20"	65"	100	15	\$974
MMBCC2072R	4	20"	20"	72"	115	17	\$1,068

Specify if standalone.

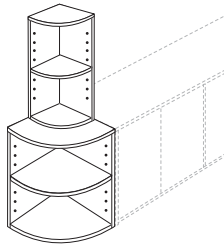

Bookcase, Corner, Left (Order separately, 1"-thick adjustable shelves)

Model#	# Shelves	Depth	Width	Height	Weight	Cube	Price
MMBCC1436L	1	14"	14"	36"	37	4	\$363
MMBCC1442L	2	14"	14"	42"	40	5	\$459
MMBCC2030L	1	20"	20"	29"	58	7	\$473
MMBCC2430L	1	24"	24"	29"	65	8	\$589
MMBCC2065L	3	20"	20"	65"	100	15	\$974
MMBCC2072L	4	20"	20"	72"	115	17	\$1,068

Specify if standalone.

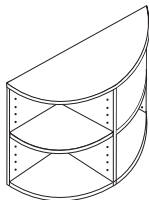

Bookcase, Half-Round (Use with team setup CompuCorners or with desks)

Model#	# Shelves	Depth	Width	Height	Weight	Cube	Price
MMBCHR1530	1	15"	30"	29"	80	8	\$657
MMBCHR1836	1	18"	36"	29"	95	12	\$719
MMBCHR2040	1	20"	40"	29"	110	16	\$774
MMBCHR2448	1	24"	48"	29"	115	20	\$856

Uses for the half-round and corner bookcases:

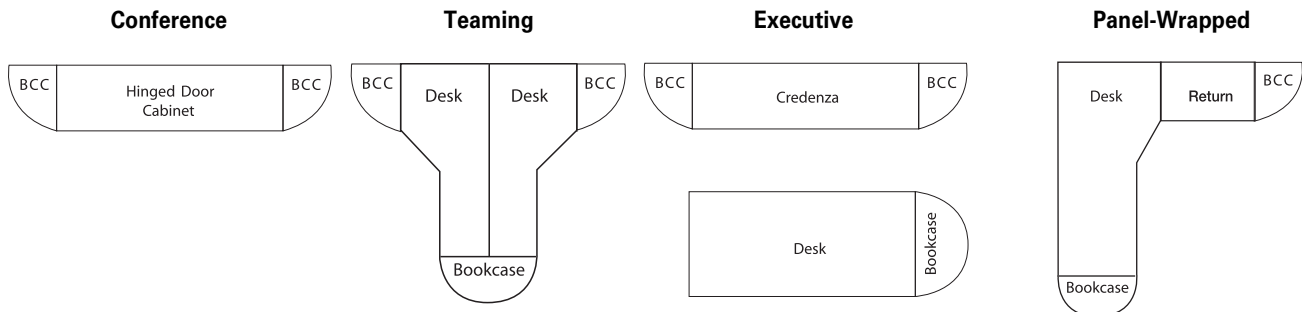



Maverick Series

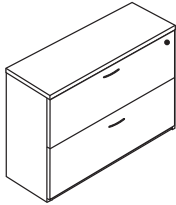

Files



2-drawer Lateral File (H3B handles, anti-tilt lock)

Model#	Depth	Width	Height	Weight	Cube	Price
 MMLF202	20"	36"	29"	160	13	\$973
 MMLF242	24"	36"	29"	176	15	\$1,015

Upgrade to H30 Handle...\$56 each.

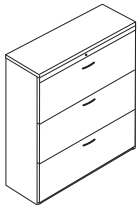

3-drawer Lateral File (H3B handles, anti-tilt lock)

Model#	Depth	Width	Height	Weight	Cube	Price
MMLF203	20"	36"	43"	240	18	\$1,527
MMLF243	24"	36"	43"	264	22	\$1,590

REQUIRES 4-WEEK LEAD TIME. Upgrade to H30 Handle...\$56 each.

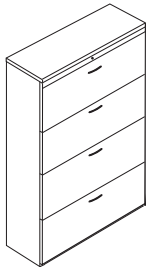

4-drawer Lateral File (H3B handles, anti-tilt lock)

Model#	Depth	Width	Height	Weight	Cube	Price
MMLF204	20"	36"	55"	330	23	\$1,953
MMLF244	24"	36"	55"	335	28	\$2,044

REQUIRES 4-WEEK LEAD TIME. Upgrade to H30 Handle...\$56 each.

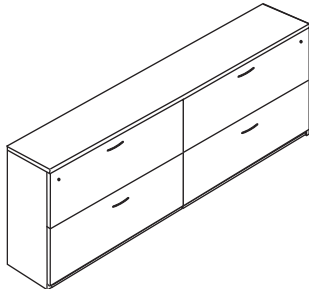

Double Lateral File (H3B handles, anti-tilt locks)

Model#	Depth	Width	Height	Weight	Cube	Price
MMLF202+2	20"	72"	29"	330	25	\$1,783
MMLF242+2	24"	72"	29"	335	30	\$1,860

Upgrade to H30 Handle...\$56 each.

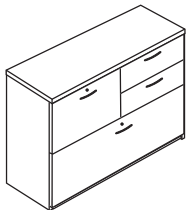

31" Personal Lateral File (H3B handles, locks)

Model#	Depth	Width	Height	Weight	Cube	Price
MMPLF20	20"	31"	29"	189	11	\$974
MMPLF24	24"	31"	29"	205	13	\$1,021

Box drawers do not lock.

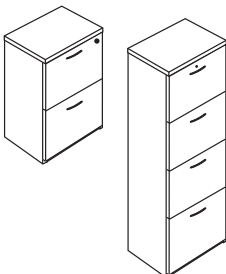

Vertical Files (H3B handles, anti-tilt lock)

Model#	Depth	Width	Height	Weight	Cube	Price
 MMVF2	24"	16"	29"	160	7	\$686
MMVF2LGL	24"	19"	29"	172	8	\$672
MMVF4*	24"	16"	55"	180	7	\$1,436
MMVF4LGL*	24"	19"	55"	190	8	\$1,556

*REQUIRES 4-WEEK LEAD TIME.

For handle selection...no charge. Specify from H5-H14, see pp. 50. See available accessories and upgrades, pp. 50-54.



Maverick Series

Pedestals - Freestanding

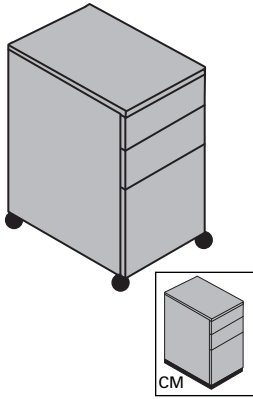

Mobile Pedestal, Box/Box/File (Fully finished, letter size, CX, CX20 with casters)

Model#	Depth	Width	Height	Weight	Cube	Price
MMPED CX	23"	16"	27 5/8"	90	6	\$686
MMPED CX20	19"	16"	27 5/8"	80	6	\$672
MMPED CM	same dimensions as CX, without casters, on a kickbase					\$686
MMPED CM20	same dimensions as CX20, without casters, on a kickbase					\$672

MMPED CX20 and CM20 have 16"-deep drawers. MMPED CX and CM have 20"-deep drawers.

CM20 & CM are on a 2"-high kickbase without casters.

One convenience tray (MM BPT) and one file bar are provided.

For handles and face lock, add MMUHL3...\$75. (Specify H3B-H14, see p. 50).

For face lock, add MMFL...\$71

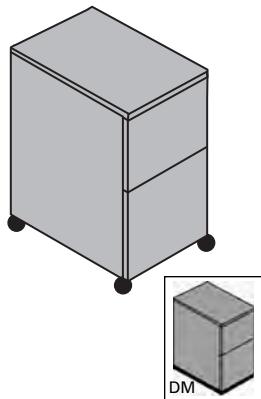

Mobile Pedestal, File/File (Fully finished, letter size, DX, DX20 with casters)

Model#	Depth	Width	Height	Weight	Cube	Price
MMPED DX	23"	16"	27 5/8"	90	6	\$686
MMPED DX20	19"	16"	27 5/8"	80	6	\$672
MMPED DM	same dimensions as DX, without casters, on a kickbase					\$686
MMPED DM20	same dimensions as DX20, without casters, on a kickbase					\$672

MMPED DX20 and DM20 have 16"-deep drawers. MMPED DX and DM have 20"-deep drawers.

DM20 & DM are on a 2"-high kickbase without casters.

One file bar provided for each file drawer.

For handles and face lock, add MMUHL2...\$51. (Specify H3B-H14, see p. 50).

For face lock, add MMFL...\$71

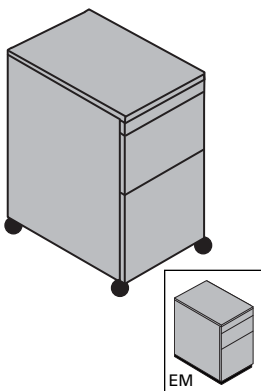

Mobile Pedestal, Pencil/Box/File (Fully finished, letter size, EX, EX20 with casters)

Model#	Depth	Width	Height	Weight	Cube	Price
MMPED EX	23"	16"	24"	90	6	\$686
MMPED EX20	19"	16"	24"	80	6	\$672
MMPED EM	same dimensions as EX, without casters, on a kickbase					\$686
MMPED EM20	same dimensions as EX20, without casters, on a kickbase					\$672

MMPED EX20 and EM20 have 16"-deep drawers. MMPED EX and EM have 20"-deep drawers.

EM20 & EM are on a 2"-high kickbase without casters. One convenience tray (MM BPT) and one file bar are provided. For handles and face lock, add MMUHL2...\$51. (Specify H3B-H14, see p. 50).

For face lock, add MMFL...\$71

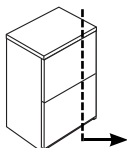

Upgrade From Standard Width Pedestal to Legal Width (Two drawers)

Model#	Depth	Width	Height	Weight	Cube	Price
MM UPEDLGL	24"	19"	varies"	128	8	\$91

NOTE: Use MM Series pedestals for Maverick and Maverick Complete Series only.

See available accessories and upgrades, pp. 49-54.

Maverick Series



Upgrades and Accessories for Hutches

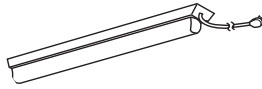

Tasklight (Black, one light only)

Model#	Depth	Width	Height	Weight	Cube	Price
MM TSKLT2	7/8"	24 1/2"	1 7/8"	2	.1	\$202

72" hutch takes 2 lights.

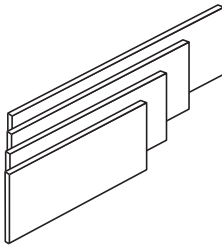

Hutch Tackboards (Uses Guilford of Maine), for Cosmopolitan & Underground fabrics...add 25%*

Model#	Depth	Width	Height	Weight	Cube	Price
MM TKBD30	1"	28"	14 1/4"	9	.5	\$355
MM TKBD42	1"	40"	14 1/4"	12	.6	\$381
MM TKBD54	1"	52"	14 1/4"	15	.7	\$440
MM TKBD60	1"	58"	14 1/4"	17	.8	\$465
MM TKBD66	1"	64"	14 1/4"	19	1	\$498
MM TKBD72	1"	70"	14 1/4"	21	1	\$530
MM TKBD78(2pc.)	1"	76"	14 1/4"	23	1	\$556

For fabric color samples, see inside back cover. COM Tackboards...add \$25/Sq. yd. Required yardage to be provided by customer. 78" width is made in 2 pieces.

Fabric Chart

STANDARD FABRICS

Tempest 2120...Zebra 015, Silk 045 **Sprite 2671**...Snow 7040, Linen 7010 **Anchorage 2335**...Sunshine 2082, Waterfall 2691, Green Apple 2087, Aubergine 2036, Goose 2049, Onyx 2016, Red Delicious 2014
Metro 3077...Storefront 030, Skyscraper 022 **Cape Cod 3073**...Linen 7031, Surf 7062
Metallation 5118...Chrome 1676, Polished Pewter 1678 **Otto 2670**...Pebble 7012, Platinum 7010

25% UPCHARGE*

* **Cosmopolitan 3097**...Ivory 020, Cornsilk 021, Everglade 010, Shadow 060, Earthen 070

* **Underground 2967**...Champagne 010, Tangerine 070, Azure 050, Ocean 041, Pepper 030, Earth 061

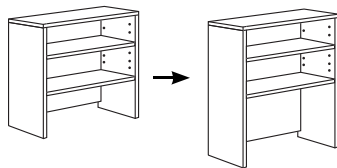

Increase 36"-height Hutch to 42"-height Hutch

MM UHH	\$162
--------	-------

Doors or shelves do not change. Available for hutches (H) and Bookcase Hutch (BCH).
 Bottom clearance increases by 6".

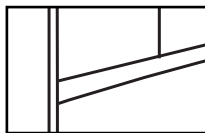

Hutch Fascia/Valance (Decreases clearance under shelf by 2")

Model#	Depth	Width	Height	Weight	Cube	Price
MM VAL	3/4"	varies	2"	varies	varies	\$124

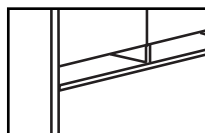

Hutch Mail Slots (Paper Manager) (Decreases clearance under shelf by 5")

Model#	Depth	Width	Height	Weight	Cube	Price
MM HMS	12"	varies	4 3/4"	varies	varies	\$208

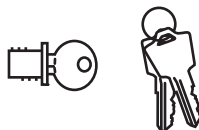

Face Lock (For hutch doors)

Model#	Price
MM FL	\$71

One per set of two doors. Hutch with four doors takes two locks. Glass doors do NOT lock.



Maverick Series

Upgrades and Accessories

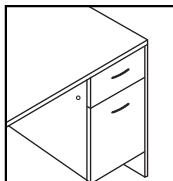

Package Upgrade (Includes 2 Handles and 1 Lock)

Model#	Depth	Width	Height	Weight	Cube	Price
MM UHL2						\$51

Specify handle option. See below for H3-H14.

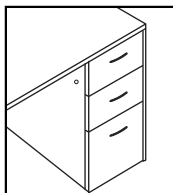

Package Upgrade (Includes 3 Handles and 1 Lock)

Model#	Depth	Width	Height	Weight	Cube	Price
MM UHL3						\$75

Specify handle option. See below for H3-H14.

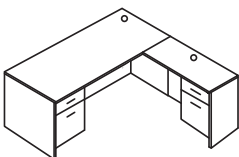

Package Upgrade, For "L" Shape Box/File Ped Units (Includes 2 Grommets, 4 Handles & 2 Locks)

Model#	Depth	Width	Height	Weight	Cube	Price
MM UGL						\$149

Grommets standard locations as shown. Specify handle option. See below for H3-H14.

HANDLE OPTIONS FOR UHL2, UHL3, UGL:

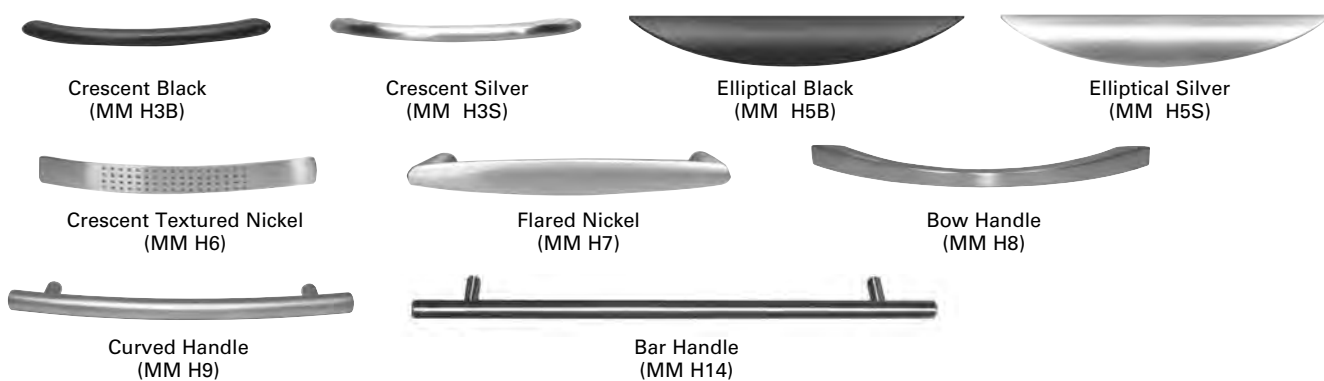

2 3/4" Plastic

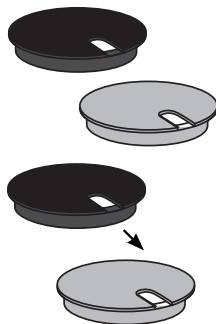

Grommet (Plastic cover, hole in surface, each)

Model#	Color	Depth	Width	Surface Hole Diameter	Price
MM GR234B	Black Plastic	3"	3"	2 3/4"	\$45
MM GR234S	Silver Plastic	3"	3"	2 3/4"	\$45

Grommet Color, Change Standard Black to Silver (2 3/4" hole in surface, each)

Model#	Color	Depth	Width	Price
MM UGR234	Silver Plastic	3"	3"	No Charge

GROMMETS (WORKSURFACE)

Note: While sitting at unit, grommet locations named from left to right.
For grommet location on tops and/or modesty panel specify left, center or right. **No grommets over pedestals.**

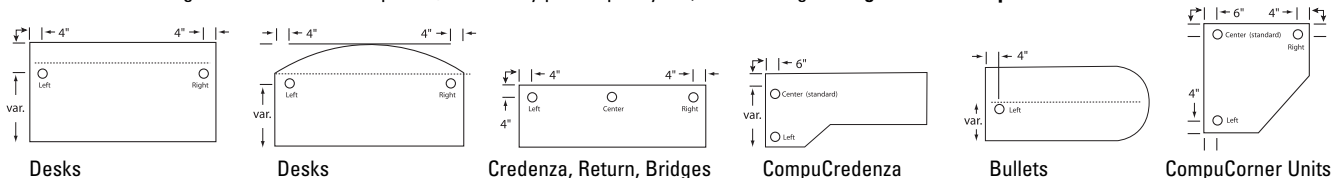

For other available accessories and upgrades, pp. 49-54.

Maverick Series

Statement of Line

RECEPTION:



Reception - Single Ped
Single ped, desk only transaction
(RCAS)

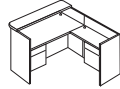

Reception - "L" Shape
Desk transaction counter only
(RCAX)

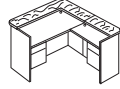

Reception - "L" Shape
Transaction counter on desk & return
(RCAL)

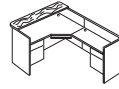

Reception - "L" Shape Computer
Desk transaction counter only
(RCDX)

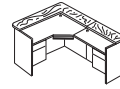

Reception - "L" Shape Computer
Transaction counter on desk & return
(RCDL)



Reception - Double Ped
Desk transaction Counter
(RCAD)

NOTES:

- Before ordering, ensure that the building and room access, including elevators, will accommodate furniture of this size. Use of pin-and-cam construction does facilitate some disassembly.
- Details of front transaction counter vary by series as do pedestals.
- Handles and locks standards vary by series.

How to Order Reception Units

WORKSURFACE UNITS: RECEPTION UNITS

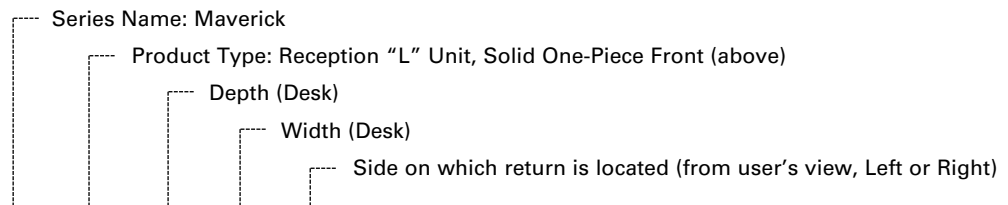

1. Product number: **MM RCAL 36 72 L**
2. Specify worksurface finish. See back cover.
3. Specify worksurface edge trim finish. Matching color edge is standard. See back cover.
4. Specify chassis finish. Matching color edge trim is standard. See back cover.
5. Specify handle (upgrade) options. See page 50 for prices.
6. Specify other accessories and upgrade options. See below and pages 50-54.

HANDLE CHOICES:

NOTE: H3, H5 thru H14 are \$25 each.



Crescent Black
(MM H3B)



Crescent Silver
(MM H3S)



Elliptical Black
(MM H5B)



Elliptical Silver
(MM H5S)



Crescent Textured Nickel
(MM H6)



Flared Nickel
(MM H7)



Bow Handle
(MM H8)



Curved Handle
(MM H9)



Bar Handle
(MM H14)

GROMMET



Black grommet standard.
Upgrade to optional silver
color, N/C.

R
E
C
E
P
T
I
O
N

IMPORTANT NOTE: Handle is optional. See page 50 for handle options and prices.



Maverick Series

Risers for Desks and Returns

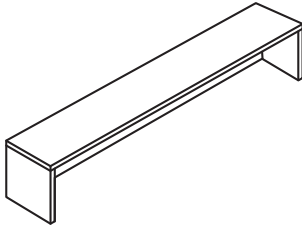

Riser (No approach overhang)

Model#	Depth	Width	Height	Weight	Cube	Price
MMRB36	12"	36"	14"	38	1	\$322
MMRB42	12"	42"	14"	43	2	\$336
MMRB48	12"	48"	14"	47	5	\$363
MMRB60	12"	60"	14"	56	6	\$521
MMRB66	12"	66"	14"	61	7	\$589
MMRB72	12"	72"	14"	65	7	\$657

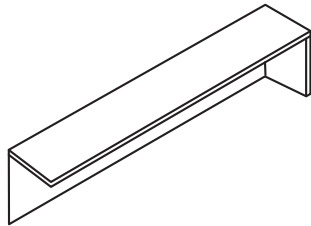

Riser Return, Right (No approach overhang)

Model#	Depth	Width	Height	Weight	Cube	Price
MMRBR36R	12"	36"	14"	32	1	\$322
MMRBR42R	12"	42"	14"	37	2	\$336
MMRBR48R	12"	48"	14"	42	5	\$363
MMRBR54R	12"	54"	14"	47	6	\$440
MMRBR60R	12"	60"	14"	51	6	\$521
MMRBR66R	12"	66"	14"	56	7	\$589
MMRBR72R	12"	72"	14"	60	7	\$657

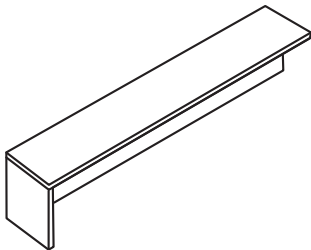

Riser Return, Left (No approach overhang)

Model#	Depth	Width	Height	Weight	Cube	Price
MMRBR36L	12"	36"	14"	32	1	\$322
MMRBR42L	12"	42"	14"	37	2	\$336
MMRBR48L	12"	48"	14"	42	5	\$363
MMRBR54L	12"	54"	14"	47	6	\$440
MMRBR60L	12"	60"	14"	51	6	\$521
MMRBR66L	12"	66"	14"	56	7	\$589
MMRBR72L	12"	72"	14"	60	7	\$657

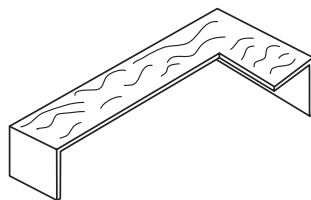

Riser "L" Shape, Right Return (12" deep, one-piece counter top)

Model#	Depth	Width	Height	Weight	Cube	Price
MMRBL3072R	30"	72"	14"	88	18	\$843
MMRBL3672R	36"	72"	14"	92	21	\$961

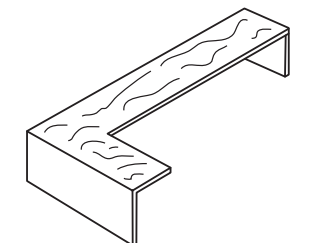

Riser "L" Shape, Left Return (12" deep, one-piece counter top)

Model#	Depth	Width	Height	Weight	Cube	Price
MMRBL3072L	30"	72"	14"	88	18	\$843
MMRBL3672L	36"	72"	14"	92	21	\$961

Notes on standard woodgrain directions:

- The front on the bridge or return unit will display the woodgrain running horizontally for 66" or larger
- On other vertical surfaces, the woodgrain runs vertically
- Worksurface woodgrain on bridge for desk runs left-to-right
- The return countertop grain direction coordinates with the desk surface, running from user's side-to-approach side except on 66" to 72" returns

Maverick Series



Reception Units - Desk and Return Transaction Counters

NOTE: Before ordering, ensure that the building and room access, including elevators, will accommodate furniture of this size. Use of pin-and-cam construction does facilitate some reassembly. **Upgrade to Full Pedestals, See page 47.**
For handles and pedestal lock packages, see page 49.

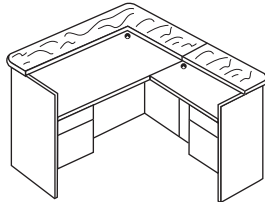

Reception "L" Unit, Solid One-Piece Front, Right Return 24" x 48"*

Model#	Depth	Width	Height	Weight	Cube	Price
*MMRCAL3060 R	72"	66"	42"	400	92	\$2,777
MMRCAL3072 R	84"	78"	42"	435	104	\$2,977
MMRCAL3672 R	90"	78"	42"	439	115	\$3,092
MMRCAL3684 R	90"	90"	42"	522	127	\$3,360

Counter top is 12" deep. Counter top approach overhang is 6". Worksurface black grommets standard. Fan top on approach side of desk counter may be specified at no upcharge, insert F before C (e.g. MMRFCAL3060R). Transaction counter to desktop clearance is 11 3/4". Upgrade grommet cover to silver, N/C.
 *MMRCAL3060 comes with a 20" x 36" return.

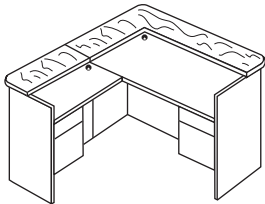

Reception "L" Unit, Solid One-Piece Front, Left Return 24" x 48"*

Model#	Depth	Width	Height	Weight	Cube	Price
*MMRCAL3060 L	72"	66"	42"	400	92	\$2,777
MMRCAL3072 L	84"	78"	42"	435	104	\$2,977
MMRCAL3672 L	90"	78"	42"	439	115	\$3,092
MMRCAL3684 L	90"	90"	42"	522	127	\$3,360

Counter top is 12" deep. Counter top approach overhang is 6". Worksurface black grommets standard. Fan top on approach side of desk counter may be specified at no upcharge, insert F before C (e.g. MMRFCAL3060L). Transaction counter to desktop clearance is 11 3/4". Upgrade grommet cover to silver, N/C.
 *MMRCAL3060 comes with a 20" x 36" return.

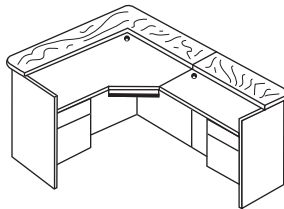

Computer Reception "L" Unit, Solid One-Piece Front, Right Return 24" x 48"

Model#	Depth	Width	Height	Weight	Cube	Price
MMRCDL3672 R	90"	78"	42"	435	88	\$3,092

Counter top is 12" deep. Counter top approach overhang is 6". Worksurface black grommets and keyboard tray standard. Fan top to approach side of desk counter may be specified at no upcharge, insert F before C (e.g. MMRFCDL3672R). Transaction counter to desktop clearance is 11 3/4". Upgrade grommet cover to silver, N/C.

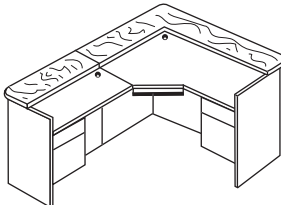

Computer Reception "L" Unit, Solid One-Piece Front, Left Return 24" x 48"

Model#	Depth	Width	Height	Weight	Cube	Price
MMRCDL3672 L	90"	78"	42"	435	88	\$3,092

Counter top is 12" deep. Counter top approach overhang is 6". Worksurface black grommets and keyboard tray standard. Fan top to approach side of desk counter may be specified at no upcharge, insert F before C (e.g. MMRFCDL3672L). Transaction counter to desktop clearance is 11 3/4". Upgrade grommet cover to silver, N/C.

Notes on standard woodgrain directions:

- The one-piece vertical front on the desk of the unit will display the woodgrain running horizontally (except 60")
- On other vertical surfaces, the woodgrain runs vertically
- Worksurface woodgrain on desk runs left-to-right
- The return worksurface grain direction coordinates with the desk surface, running from user's side to the approach side
- Transaction counter woodgrain runs the same direction as the worksurface woodgrain

See available accessories and upgrades, pp. 49-54.



Maverick Series

Reception Units - Desk-Only Transaction Counters, "L"s and Reception Desks

NOTE: Before ordering, ensure that the building and room access, including elevators, will accommodate furniture of this size. Use of pin-and-cam construction does facilitate some reassembly. **Upgrade to Full Pedestals, See below.**
For handles and Pedestal Lock Packages, P. 49.

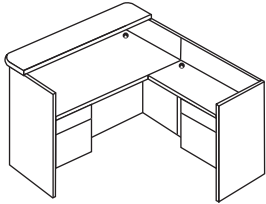

Reception "L" Unit, Solid One-Piece Front, Right Return 24" x 48"* (Desk counter only)

Model#	Depth	Width	Height	Weight	Cube	Price
MMRCAX3060 R*	72"	60"	42"	390	92	\$2,599
MMRCAX3072 R	84"	72"	42"	425	92	\$2,757
MMRCAX3672 R	90"	72"	42"	430	92	\$3,052
MMRCAS3072 R	30"	72"	42"	250	63	\$1,789
MMRCAD3072	30"	72"	42"	320	63	\$2,077

Counter top is 12" deep. Counter top approach overhang is 6". Worksurface black grommets standard.
 Fan top on approach side of desk counter may be specified at no upcharge, insert F before C (e.g. MMRFCAX3060R).
 Transaction counter-to-desktop clearance is 11 3/4". *MMRCAL3060 comes with a 20" x 36" return.
 Upgrade grommet cover to silver, N/C.

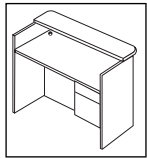

MMRCAS3072R

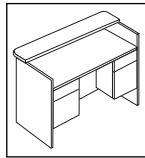

MMRCAD3072

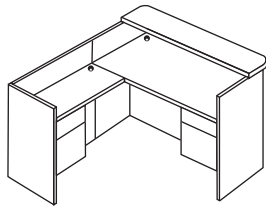

Reception "L" Unit, Solid One-Piece Front, Left Return 24" x 48"* (Desk counter only)

Model#	Depth	Width	Height	Weight	Cube	Price
MMRCAX3060 L*	72"	60"	42"	390	92	\$2,599
MMRCAX3072 L	84"	72"	42"	425	92	\$2,757
MMRCAX3672 L	90"	72"	42"	430	92	\$3,052
MMRCAS3072 L	30"	72"	42"	250	63	\$1,789
MMRCAD3072	30"	72"	42"	320	63	\$2,077

Counter top is 12" deep. Counter top approach overhang is 6". Worksurface black grommets standard.
 Fan top on approach side of desk counter may be specified at no upcharge, insert F before C (e.g. MMRFCAX3060L).
 Transaction counter-to-desktop clearance is 11 3/4". *MMRCAL3060 comes with a 20" x 36" return.
 Upgrade grommet cover to silver, N/C.

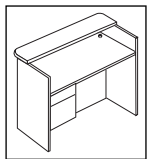

MMRCAS3072L

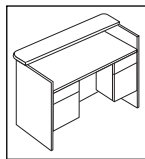

MMRCAD3072

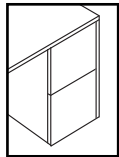
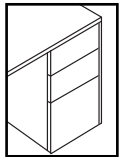

Upgrade to Full Pedestals (19" or 23" deep)

Model#	Depth	Width	Height	Weight	Cube	Price
MMUPEDC	19"	15 3/4"	25 3/16"	75	6	\$274
Box/Box/File (ea.)						
MMUPEDD	19"	15 3/4"	25 3/16"	75	6	\$235
File/File (ea.)						

Notes on standard woodgrain directions:

- The one-piece vertical front on the desk of the unit will display the woodgrain running horizontally (except 60")
- On other vertical surfaces, the woodgrain runs vertically
- Worksurface woodgrain on desk runs left-to-right
- The return worksurface grain direction coordinates with the desk surface, running from user's side to the approach side
- Transaction counter woodgrain runs the same direction as the worksurface woodgrain

For handle packages, specify from H3B-H14, see pp. 50. See available accessories and upgrades, pp. 49-54.

Maverick Series



Reception Units - Desk and Return Transaction Counters

NOTE: Before ordering, ensure that the building and room access, including elevators, will accommodate furniture of this size. Use of pin-and-cam construction does facilitate some reassembly. **Upgrade to Full Pedestals, See below.**
For handles and Pedestal Lock Packages, P. 49.

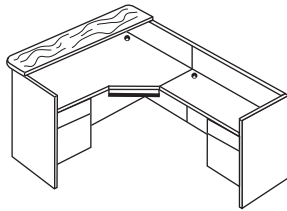

Computer Reception "L" Unit, Solid One-Piece Front, Right Return 24" x 48"

Model#	Depth	Width	Height	Weight	Cube	Price
MMRCDX3672 R	90"	72"	42"	425	88	\$2,757

Counter top is 12" deep. Counter top approach overhang is 6". Worksurface black grommets and keyboard tray standard. Fan top on approach side of desk counter may be specified at no upcharge, insert F before C (e.g. MMRFCDX3672R). Desk counter only. Transaction counter-to-desktop clearance is 11 3/4". Upgrade grommet cover to silver, N/C.

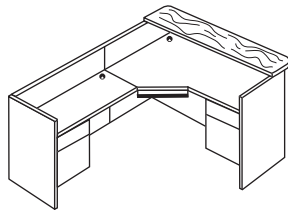

Computer Reception "L" Unit, Solid One-Piece Front, Left Return 24" x 48"

Model#	Depth	Width	Height	Weight	Cube	Price
MMRCDX3672 L	90"	72"	42"	425	88	\$2,757

Counter top is 12" deep. Counter top approach overhang is 6". Worksurface black grommets and keyboard tray standard. Fan top on approach side of desk counter may be specified at no upcharge, insert F before C (e.g. MMRFCDX3672L). Desk counter only. Transaction counter-to-desktop clearance is 11 3/4". Upgrade grommet cover to silver, N/C.

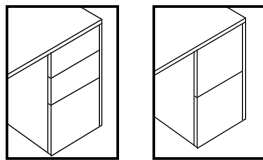

Upgrade to Full Pedestals (19" or 23" deep)

Model#	Depth	Width	Height	Weight	Cube	Price
MMUPEDC	19"	15 3/4"	25 3/16"	75	6	\$274

Box/Box/File (ea.)

MMUPEDD	19"	15 3/4"	25 3/16"	75	6	\$235
---------	-----	---------	----------	----	---	-------

File/File (ea.)

Notes on standard woodgrain directions:

- The one-piece vertical front on the desk of the unit will display the woodgrain running horizontally (except 60")
- On other vertical surfaces, the woodgrain runs vertically
- Worksurface woodgrain on desk runs left-to-right
- The return worksurface grain direction coordinates with the desk surface, running from user's side to the approach side
- Transaction counter woodgrain runs the same direction as the worksurface woodgrain



Maverick Series

Upgrades and Accessories for Reception Units

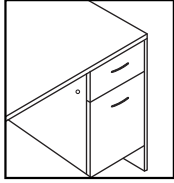

Package Upgrade (Includes 2 Handles and 1 Lock)

Model#	Depth	Width	Height	Weight	Cube	Price
MM UHL2						\$51

Specify handle option.

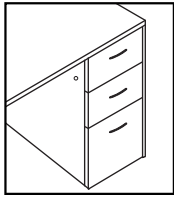

Package Upgrade (Includes 3 Handles and 1 Lock)

Model#	Depth	Width	Height	Weight	Cube	Price
MM UHL3						\$75

Specify handle option.

HANDLE OPTIONS SELECTION FOR PACKAGES ABOVE:



Crescent Black
(MM H3B)



Crescent Silver
(MM H3S)



Elliptical Black
(MM H5B)



Elliptical Silver
(MM H5S)



Crescent Textured Nickel
(MM H6)



Flared Nickel
(MM H7)



Bow Handle
(MM H8)



Curved Handle
(MM H9)



Bar Handle
(MM H14)

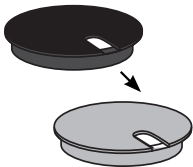

Grommet Color, Change Standard Black to Silver (2 3/4" hole in surface, each)

Model#	Color	Depth	Width	Price
 MM UGR234	Silver Plastic	3"	3"	No Charge

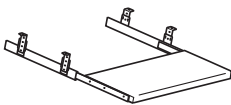

Keyboard Tray, Rollout (Specify laminate color)

Model#	Depth	Width	Height	Weight	Cube	Price
 MM KB	16"	21"	3"	10	.5	\$124

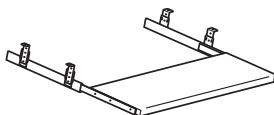

Oversize Keyboard Tray, Rollout (Specify laminate color)

Model#	Depth	Width	Height	Weight	Cube	Price
 MM KBLG	16"	28"	3"	12	.5	\$182



Maverick Series



Accessories





Crescent Handle, Metal - Black or Silver Finish

	Model#	Hole Center	Width	Color	Price
	MM H3B	5"	5 3/4"	Black	\$27/ea.
	MM H3S	5"	5 3/4"	Silver	\$27/ea.



Elliptical Handle, Metal - Black or Silver Finish

	Model#	Hole Center	Width	Color	Price
	MM H5B	5"	6 3/4"	Black	\$27/ea.
	MM H5S	5"	6 3/4"	Silver	\$27/ea.



Crescent Textured Nickel Handle, Metal - Silver Finish

	Model#	Hole Center	Width	Price
	MM H6	5"	6 1/4"	\$27/ea.



Flared Nickel Handle, Metal - Silver Finish

	Model#	Hole Center	Width	Price
	MM H7	5"	6 1/4"	\$27/ea.



Bow Handle, Silver Finish

	Model#	Hole Center	Width	Price
	MM H8	5"	6 1/8"	\$27/ea.



Curved Handle, Silver Finish

	Model#	Hole Center	Width	Price
	MM H9	5"	6 1/2"	\$27/ea.





Bar Handle, Silver Finish

	Model#	Hole Center	Width	Price
	MM H14	11"	14"	\$27/ea.
	MM H30	27"	30"	\$56/ea.

30"W handles do not fit on pedestal drawers or hutch doors.

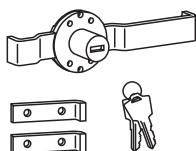
Pedestal Lock (Mounted on side of pedestal - specify user's view L or R for mobile ped)



	Model#	Price
	MM PL	\$71

For mobile pedestals, specify user's view L or R.

Maverick Series

Accessories and Upgrades

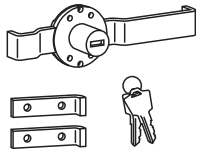

Pedestal Lock (Mounted on side of pedestal - specify user's view L or R for mobile peds)

Model#	Price
Qs MM PL	\$71

For mobile pedestals, specify user's view L or R.

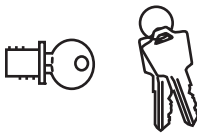

Face Lock (For center drawers & hinged doors)

Model#	Price
Qs MM FL	\$71

One per set of two doors or drawers. Hutch with two or four doors takes two locks.

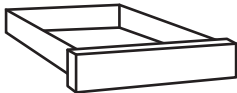

Center Drawer (9-ply birch wood drawer interior, specify front laminate color)

Model#	Depth	Width	Height	Weight	Cube	Price
Qs MM CD	16"	21"	2 1/2"	12	.5	\$135



Box Drawer Convenience Tray (Insets to box drawer)

Model#	Depth	Width	Height	Weight	Cube	Price
Qs MM BPT	5 1/2"	12"	1"	1	.5	\$27

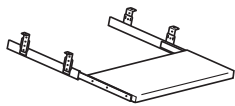

Keyboard Tray, Rollout (Specify laminate color)

Model#	Depth	Width	Height	Weight	Cube	Price
Qs MM KB	16"	21"	3"	10	.5	\$124

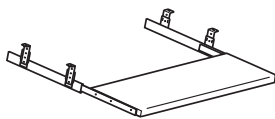

Oversize Keyboard Tray, Rollout (Specify laminate color)

Model#	Depth	Width	Height	Weight	Cube	Price
Qs MM KBLG	16"	28"	3"	12	.5	\$181

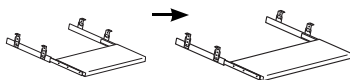

Standard Keyboard Tray to Oversize Keyboard Tray (Upgrade)

Model#	Depth	Width	Height	Weight	Price
Qs MM UKBLG	16"	28"	3"	12	\$64

Maverick Series

Accessories and Upgrades

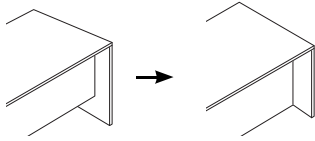

3/4 Modesty Panel Upgrade to Full Modesty Panel

Model#	Depth	Width	Height	Weight	Cube	Price
Qs MM FMP	3/4"	varies	28"	varies	varies	\$59

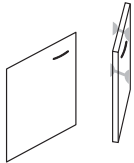

Optional Hinged Doors to Replace Sliding Doors on Storage Credenzas or Flip-up Doors on Overheads (Two doors), choice of handles

Model#	Depth	Width	Height	Weight	Cube	Price
MM UPHD2	3/4"	varies	varies	varies	varies	\$187

H3B handles standard. Handle position for credenza shown.

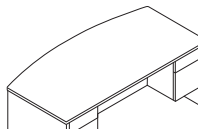

Fantop - Add (Increases depth by 6" at center on approach side)

Model#	Depth	Width	Height	Weight	Cube	Price
Qs MM FAN	varies	varies	1"	varies	varies	\$261

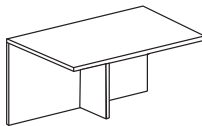

Support Panel with leveler ("Half-leg" - add to long pieces or to computer desk)

Model#	Depth	Width	Height	Weight	Cube	Price
Qs MM SPT	12"	1"	28"	11	3	\$102

Support panel can also be used to create freestanding returns. Specify location left or right 1/2 leg.

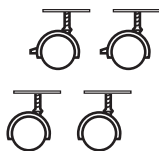

Casters, Set of Four (For stands & HDC only. Two locking, two non-locking)

Model#	Height	Price
MM CAS	2 1/2"	\$91

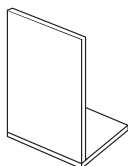

CPU Section (Add to desk, return or credenza, each CPU1 for 3/4 height, CPU2 for full height ped)

Model#	Depth	Width	Height	Weight	Cube	Price
MM CPU1	16"	10"	18 3/4"	15	2	\$103
MM CPU2	16"	10"	27 5/8"	18	3	\$129

Specify left or right mount.

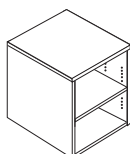

Printer Stand (Adjustable shelf, two back openings. Caster option, see above)

Model#	Depth	Width	Height	Weight	Cube	Price
MM PS2424	24"	24"	29"	65	10	\$530

For casters, add MMCAS...\$91

Maverick Series

Accessories and Upgrades

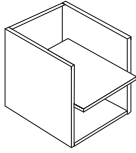

Printer Shelf with Roll-out Shelf (Add to desk, return or credenza, each)

Model#	Depth	Width	Height	Weight	Cube	Price
MM PSS	22"	24"	28"	53	10	\$343

Rollout shelf is installed 1" clear from bottom.

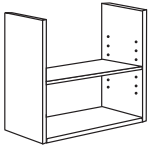

Bookcase Section (One fixed shelf, one adjustable. Add to bridge or return)

Model#	Depth	Width	Height	Weight	Cube	Price
MM BCS	12"	32"	28"	varies	varies	\$240

No back panel.



Additional Bookcase Shelf (1" -thick standard, with shelf pins)

Model#	Depth	Width	Height	Weight	Cube	Price
MM SH1	11 ¹ / ₁₆ "	33 ³ / ₄ "	1"	13	.5	\$103

Fits standard bookcases.

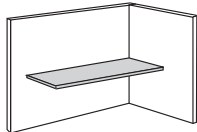

Purse Shelf (Add to desk, return or credenza)

Model#	Depth	Width	Height	Weight	Cube	Price
MM PS	10"	varies	³ / ₄ "	varies	varies	\$100

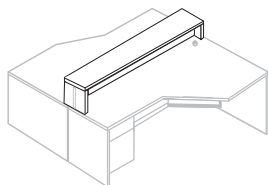

Privacy Shelf/Divider (12" counter top with centered modesty)

Model#	Depth	Width	Height	Weight	Cube	Price
MM B36	12"	36"	14"	40	4	\$304
MM B42	12"	42"	14"	40	4	\$317
MM B48	12"	48"	14"	40	4	\$330
MM B54	12"	54"	14"	41	5	\$414
MM B60	12"	60"	14"	43	5	\$491
MM B66	12"	66"	14"	49	6	\$556
MM B72	12"	72"	14"	55	6	\$621

Maverick Series

Accessories and Upgrades

Cut Charges

Standard Cuts and Reprogramming Charges (Extends lead time)

Model#	Maverick Series Only	Price
MM CUT1	Height or Width or Depth, 90° Cut on 90° Pieces	\$91
MM CUT2	Two Dimensions, 90° Cuts on 90° Pieces	\$142
MM CUT3	Program Charge on Piece with Cut other than 90°	\$142

For Maverick Series cut charges items only.

High Pressure Laminate

HPL Tops (Maverick standard colors only. Extends lead time)

Model#		Price
MM HPLM	Matte High Pressure Laminate Top Only	Call for quote
MM HPLG	Gloss High Pressure Laminate Top Only	Call for quote
MM HPB	Backer Sheet for Underneath Side Top Only	Call for quote

Call Customer Service for quote. For custom HPL color laminates, please submit quote.

Carton

Cartoning Charges

Model#		Price
 MM CAR4	Pallet Cartoning	25%

(Corner & edge protectors w/bubble/shrink wrap, place in carton, strap to pallet)

Maverick Complete

mav • er • ick: (adjective)

being independent in thought and action
or exhibiting such independence



Well Beyond the Ordinary

Complete flexibility for every working environment, from private to open spaces, reception areas to team stations or the big corner office.

You've Made the Right Choice

A perfect balance of performance, appearance and budget-stretching value. Maverick is backed by a solid reputation and superior customer service.



Maverick Complete

Modern, clean-cut, contemporary styling. A full line of stand-alone casegoods and accessories for executive, team and panel-wrapped contract office settings. Our most popular and most complete series.

Product Specifications

Colors

- All 18 standard colors are available on tops and chassis

Tops/Worksurfaces

- 1" TFM (Thermally Fused Melamine) on industrial quality (45 lb.) particleboard
- 2 mm thermally-fused PVC edge banding
- Conference table tops present a 1 3/4" built-up edge
- Metal-to-metal connection fittings are installed for bridges and returns
- Woodgrain direction on tops of bridges and returns runs from user side to approach side to coordinate with main unit tops



Configuration MC4 shown above with additional MCBCB bookcase hutch and white gloss finish.

Chassis Construction

- TFM chassis fastened by screws, steel brackets, and/or concealed fasteners
- 1"-thick end panels on desks, returns, credenzas, and bookcases. 3/4" thick end panels on hutches
- Full-height modesty panel is standard on all desks, credenzas, bridges & returns; 12" modesty may be specified at no upcharge on bridges and returns
- Bullet desks are standard with full modesty panel and have 4" black metal posts
- Conference tables are provided with 7" modesty panel
- Unless otherwise specified, conference and round table bases are the same color as the top. Contrasting colors may be specified at no charge
- The modesty inset on the approach side for 30"-deep tops is 6"; for 36"-deep tops, inset is 12"
- The modesty panel is flush to the approach edge on 20"-and 24"-deep tops
- Visible edges are edged with 2 mm thermally-fused PVC edge banding
- Adjustable leveling glides are provided on all units that are designed to be set on the floor
- Hutches for Maverick Series are designed to fit Maverick Series ONLY.
- Product heights are coordinated to facilitate matching, e.g., credenza plus hutch is 65" high. Optional 72" height is available, see page 94
- Standard woodgrain direction on the modesty of pieces 60" wide or less is vertical. On pieces wider than 60", the grain direction is horizontal
- Lateral file and vertical file chassis are all 3/4" material

Drawer Interiors

- 9-ply Birch wood drawers

Drawer Suspension, Construction and Doors

- Box drawers have full-extension, progressive-action slides with precision steel ball bearings
- Heavy-duty file rods in file drawers
- Handles are standard on all pedestals, lateral files, freestanding pedestals and tower storage
- All units have MMH3B handles standard
- Overlay drawer front and doors are standard on all separate storage units and separate file units. Other furniture with storage and lateral file elements are inset to the end panels of chassis and overlay at the kneespace
- All file and lateral drawers file legal-size from side-to-side
- Each desk only is provided with one box drawer convenience tray. See page 103 for optional additional trays for other units
- File drawer construction accommodates hanging files not stacked material on drawer bottom
- Hutch doors overlay sides before inset to top with 19" clearance below

Cord Management

- Centered grommets in the worksurface and modesty are standard on bridges, credenzas and returns; 3/4" clearance at bottom of hutch backs
- Optional wire management is available - grommets on page 102

Locks

- Locks are standard on all pedestals, lateral files, freestanding pedestals and tower storage
- Black or silver, removable cores are standard for all locks
- Pedestal key numbers are randomly assigned to all locking pedestals, except that double pedestal units will be keyed alike
- Master keys and keyed-alike combinations are available

Note: Dimensions assigned in this price list are nominal. If exact measurements are required, the requirement must be specified in the order and specifically acknowledged by Maverick. Maverick reserves the right to change construction details and standards without notification, if necessary.

Maverick Complete

How to Order Maverick Complete

WORKSURFACE UNITS: DESKS, CREDENZAS AND RETURNS

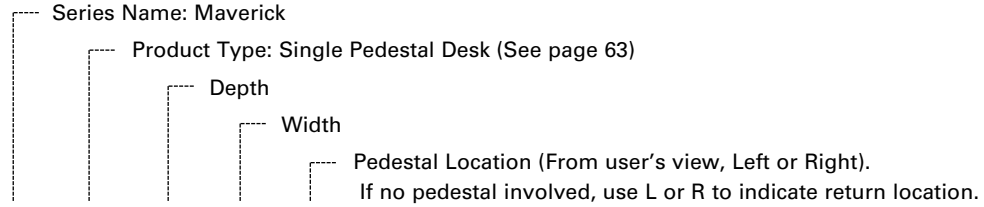

1. Product number: **MC S 36 72 L**
2. Specify Worksurface Finish. See back cover.
3. Specify Worksurface Edge Banding Finish. Matching color edge banding is standard. See back cover.
4. Specify Chassis Finish. Matching color edge banding is standard. See back cover.
5. Specify Handle Upgrade Options. H3B is standard on storage and lateral file units only. See below and page 102.
6. Specify Other Accessories or Upgrades. See below and pages 103-106.

HANDLE UPGRADE OPTIONS:

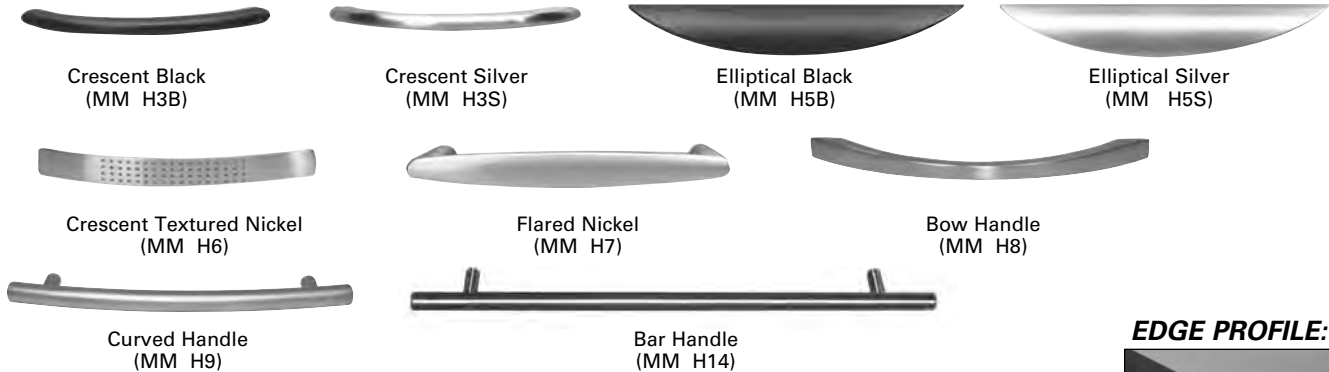

IMPORTANT NOTE: H3B handle is standard only on Maverick Series storage units and lateral files (except sliding door credenzas). See page 103 for prices. H3, H5 thru H14 are \$25 each, H30...\$52 each.

EDGE PROFILE:



2 mm flat PVC edge banding on tops

SIDE VIEW:



GROMMET



Black grommet standard. Upgrade to silver color, N/C.

OTHER OPTIONS/UPGRADES:

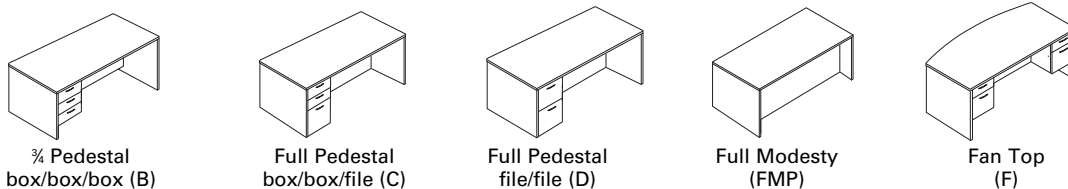

Grommets (WORKSURFACE)

Note: While sitting at unit, grommet locations named from left to right. For grommet location on tops and/or modesty panel specify left, center or right. **No grommets over pedestals.**

*** NOTE: CENTER GROMMET IS STANDARD**

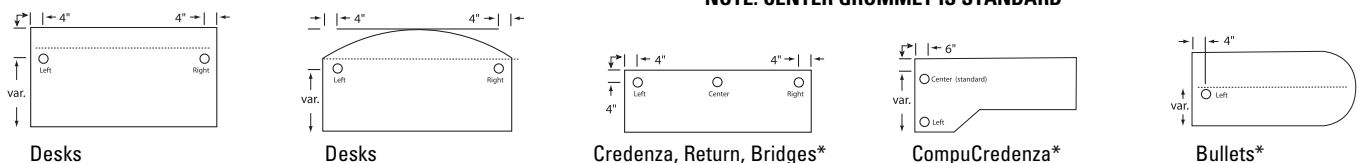

Maverick Complete



Statement of Line

DESKS:

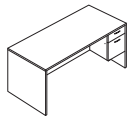

Desk - single pedestal (S)

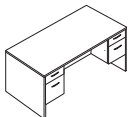

Desk - double pedestal (D)

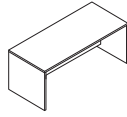

Desk - shell (N)

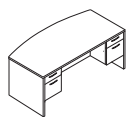

Desk Fan Top - dbl. ped. (FD)

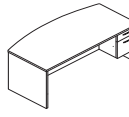

Desk Fan Top - sgl. ped. (FS)



Bullet Desk - standard (BD)

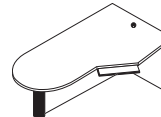

Bullet Computer Desk (BDC)

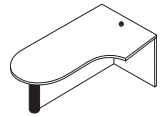

Bullet Computer Desk Curved (BDCQ)

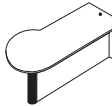

Desk - P-shape (PBD)

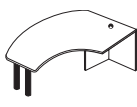

Wedge (BWQ)

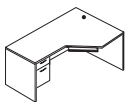

Comp. Desk - sgl. ped. (CD72 9)(Front Unit)

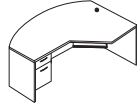

Fan Top Comp. Desk - sgl. ped. (FCD72 9)(Front Unit)

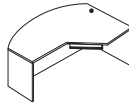

Fan Top Comp. Desk - shell (FCDN72 9)

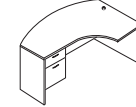

Fan Top Comp. Desk Curved - sgl. ped. (FCDQ72 9)

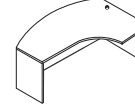

Fan Top Comp. Desk Curved - shell (FCDNQ72 9)

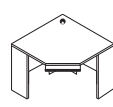

CompuCorner Unit - component (CCU)

CRENZAS:



CompuCorner Unit Curved - component (CCUQ)

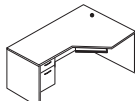

CompuCorner - sgl. ped. (CD)

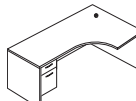

CompuCorner Curved - sgl. ped. (CDQ)

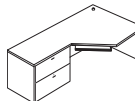

CompuCorner - 31" lateral (CDLF)

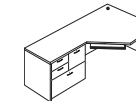

CompuCorner - 31" pers. lat. file (CDPLF)



CompuCorner - shell (CDN)

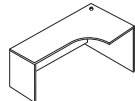

CompuCorner - curved shell (CDNQ)

CRENZAS:

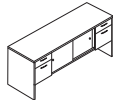

Credenza - dbl. ped. & storage (C_2)

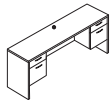

Credenza - dbl. ped. (kneespace) (C_3)

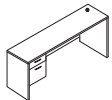

Credenza - sgl. ped. (C_4)

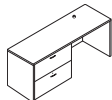

Credenza - lat. file (C_5)

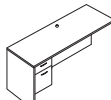

Credenza - pers. lat. file (C_6)

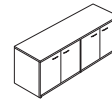

Credenza - full storage (C_1FP)

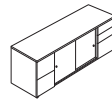

Credenza - 2 full ped./storage (C_2FP)

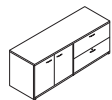

Credenza - Storage File (C_9FP)

RETURNS:

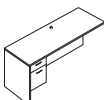

Return - 3/4 ped. (RA)

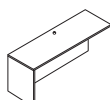

Return - shell (RN)



Return - lat. file (RLF)

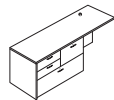

Return - Pers. Lat. File (RPLF)

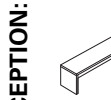

Bridge - reception (RB)

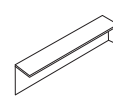

Bridge - reception return (RBR)

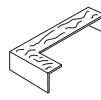

Bridge - reception L (RBL)

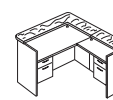

Reception - "L" (RCAL)

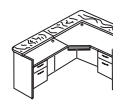

Reception - computer (RCDL)

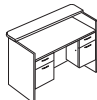

Reception - front (RCAD)

RECEPTION:

BRIDGE:



Bridge (BR)

HUTCHES:

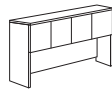

Hutch - with doors (H_WD)

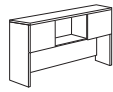

Hutch - 2 door (H_W2D)

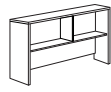

Hutch - no doors (H_ND)



Hutch - bookcase (BCH)

BOOKCASES:

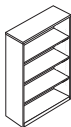

Bookcase (BC)

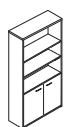

Bookcase - storage (BCD)

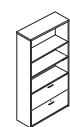

Bookcase - lateral (BCLF)



Bookcase - half round (BCHR)

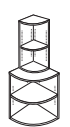

Bookcase - corner (BCC)

FILING:

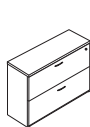

Lateral File (LF2)



Lateral File - 3-drawer (LF3)

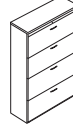

Lateral File - 4-drawer (LF4)

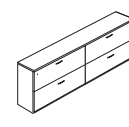

Lateral File - double (LF_2+2)

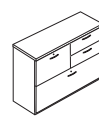

Lateral File - personal (PLF)



Vertical File (VF)

CONFERENCE:

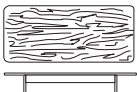

Conference Table - rectangular (RE)

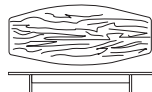

Conference Table - boatshape (BS)

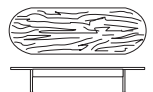

Conference Table - racetrack (RT)



Table - round (RD)

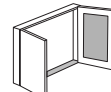

Conference board (CB)



Lectern (LT)

STORAGE:



Cabinet - single (STS)

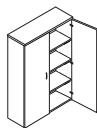

Cabinet - double (ST)

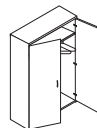

Cabinet - wardrobe (WC)



Personal Storage Unit (WCP)

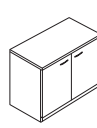

Cabinet - utility (HDC)

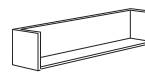

Cabinet - overhead (CFOHA)

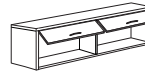

Cabinet - overhead (CFOHB)

STANDS:



Printer Stand (PS)

PEDESTALS:



Mobile - box/box/file (PEDCX)



Mobile - file/file (PEDDX)



Mobile - Pencil/Box/file (PEDEX)



Maverick Complete

Configurations - All are available on

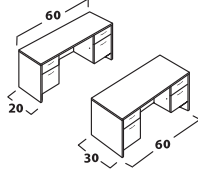

- MC1**
- 1 MCD3060 \$1,097
 - 1 MCC2060 3 \$1,165
 - \$2,114**

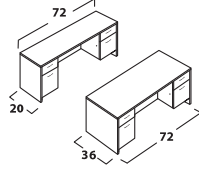

- MM 2**
- 1 MC D3672 \$1,329
 - 1 MC C2072 3 \$1,380
 - \$2,532**

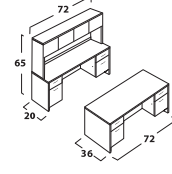

- MC3**
- 1 MCD3672 \$1,329
 - 1 MCC2072 3 \$1,380
 - 1 MCH72WD \$1,240
 - \$3,691**

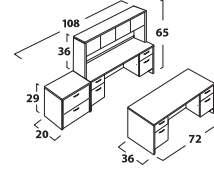

- MC4**
- 1 MCD3672 \$1,329
 - 1 MCC2072 3 \$1,380
 - 1 MCH72WD \$1,240
 - 1 MCLF202 \$973
 - \$4,491**

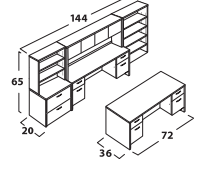

- MC5**
- 1 MCD3672 \$1,329
 - 1 MCC2072 3 \$1,380
 - 1 MCH72WD \$1,240
 - 1 MCLF202 \$973
 - 1 MCBCH \$411
 - 1 MCBC3665 \$672
 - \$5,503**

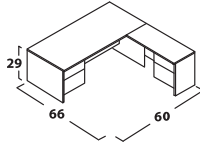

- MC6R**
- 1 MCS3060L \$890
 - 1 MCRA2036R \$830
 - \$1,608**

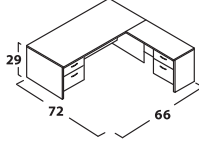

- MC7R**
- 1 MCS3066L \$985
 - 1 MCRA2442R \$948
 - \$1,807**

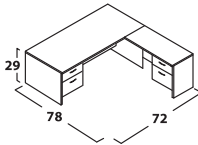

- MC8R**
- 1 MCS3672L \$1,049
 - 1 MCRA2442R \$948
 - \$1,866**

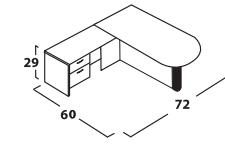

- MC9L**
- 1 MCB3060L \$843
 - 1 MCRA2042L \$843
 - \$1,576**

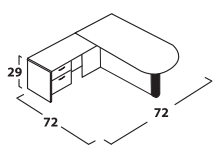

- MC10L**
- 1 MCB3672L \$1,007
 - 1 MCRA2436L \$921
 - \$1,802**

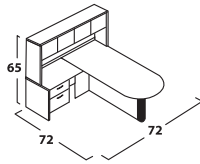

- MC11L**
- 1 MCB3672L \$1,007
 - 1 MCRA2436L \$921
 - 1 MCH72WD \$1,240
 - \$2,961**

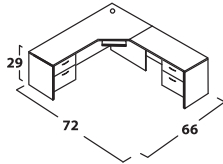

- MC13R**
- 1 MCCD66 4L \$1,124
 - 1 MCRA2436R \$921
 - \$1,911**

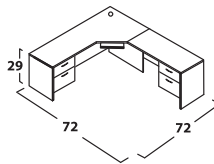

- MC14R**
- 1 MCCD72 4L \$1,076
 - 1 MCRA2436R \$921
 - \$1,867**

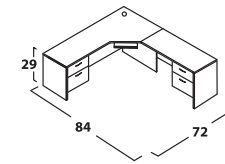

- MC15R**
- 1 MCCD72 4L \$1,076
 - 1 MCRA2448R \$960
 - \$1,903**

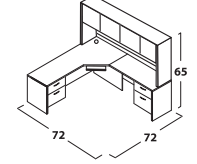

- MC16R**
- 1 MCCD72 4L \$1,076
 - 1 MCRA2436R \$921
 - 1 MCH72WD \$1,240
 - \$3,026**

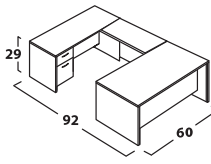

- MC17L**
- 1 MCS3060R \$890
 - 1 MCBR2042 \$378
 - 1 MCC2060 4L \$948
 - \$2,071**

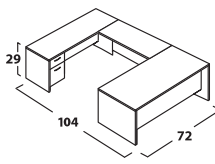

- MC18L**
- 1 MCS3672R \$1,048
 - 1 MCBR2448 \$501
 - 1 MCC2072 4L \$1,057
 - \$2,436**

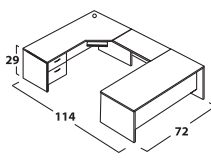

- MC19L**
- 1 MCS3672R \$1,048
 - 1 MCBR2442 \$460
 - 1 MCCD72 4L \$1,076
 - \$2,416**

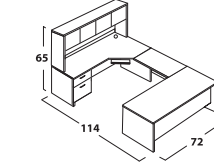

- MC20L**
- 1 MCS3672R \$1,048
 - 1 MCBR2442 \$460
 - 1 MCCD72 4L \$1,076
 - 1 MCH72WD \$1,240
 - \$3,575**

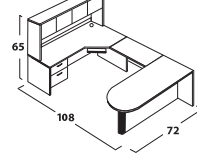

- MC22L**
- 1 MCB3072L \$952
 - 1 MCBR2442 \$460
 - 1 MCCD72 4L \$1,076
 - 1 MCH72WD \$1,240
 - \$3,485**

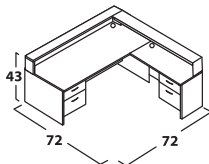

- MC23R**
- 1 MCS3072L \$1,002
 - 1 MCRA2442R \$948
 - 1 MCRB72 \$657
 - 1 MCRBR60R \$521
 - 2 MC GR234 \$90
 - \$3,007**

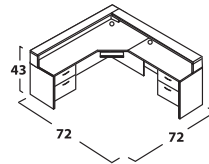

- MC25R**
- 1 MCCD72 4L \$1,076
 - 1 MCRA2436R \$921
 - 1 MCRB72 \$657
 - 1 MCRBR60R \$521
 - 1 MC GR234 \$45
 - \$3,010**

Maverick Complete - Curved

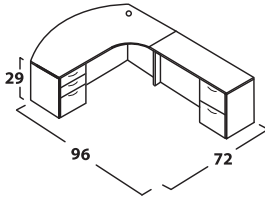

Curved Configurations

**MQ1R**

1 MCFCDQ72C9L	\$1,920
1 MCRD2448R	\$1,186
	\$2,980

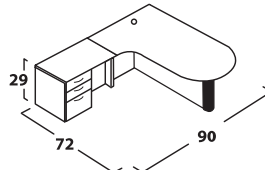
**MQ2L**

1 MCBDCQ427230L FMP	\$1,028
1 MCRC2448L	\$1,328
	\$2,202

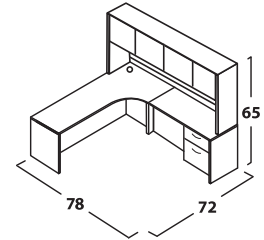
**MQ3R**

1 MCCDNQ72 4R	\$926
1 MCRA2436R	\$921
1 MCH 72 WD	\$1,240
	\$2,885

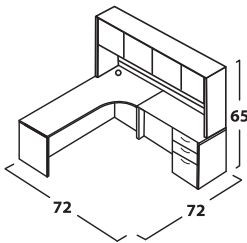
**MQ4R**

1 MCCDNQ72 4R	\$926
1 MCRC2436R	\$921
1 MCH72 WD	\$1,240
	\$3,229

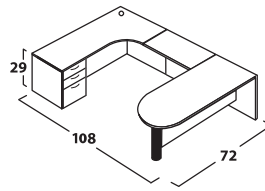
**MQ5L**

1 MCB3672 L	\$1,007
1 MCBR2436	\$393
1 MCCDQ72C4L	\$1,446
	\$2,659

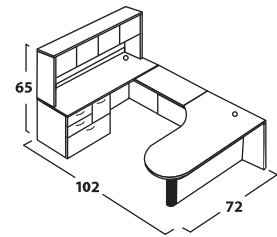
**MQ6L**

1 MCBDCQ427230L	\$1,028
MCBR2436	\$393
1 MCC24726L	\$1,741
1 MCH72 WD	\$1,240
	\$4,114

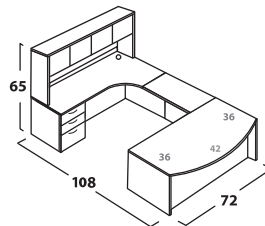
**MQ7L**

1 MCFSC3672R	\$1,637
1 MCBR2436	\$393
1 MCCDQ72C 4L	\$1,816
1 MCPED CM	\$755
1 MCH72 WD	\$1,240
	\$5,113

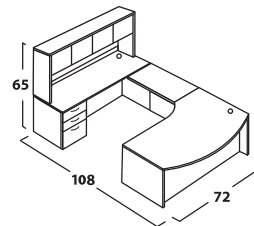
**MQ8L**

1 MCFCDQ72C 9R	\$1,920
1 MCBR2436	\$393
1 MCC2472 4L	\$1,453
1 MCH72 WD	\$1,240
	\$4,678



Maverick Complete

Quickship Teaming Set-up Suggestions **Qs**

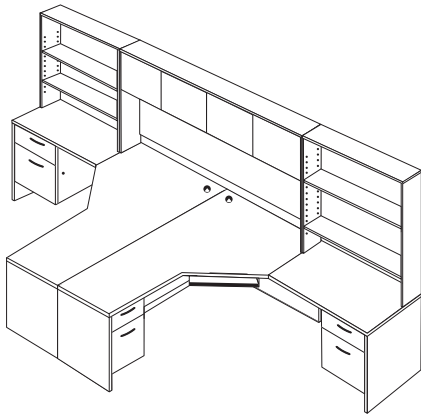

- 1 MCCD72 4R \$1,076
- 1 MCCD72 4L \$1,076
- 1 MCRA2436R \$921
- 1 MCRA2436L \$921
- 2 MCBCH \$822
- 1 MCH72 WD \$1,240
- \$5,277**

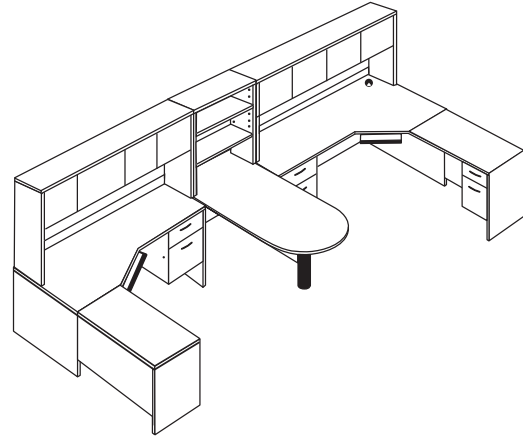

- 1 MCCD72 4R \$1,076
- 1 MCCD72 4L \$1,076
- 1 MCRA2436R \$921
- 1 MCRA2436L \$921
- 1 MCB3672 \$1,007
- 2 MCH72WD \$2,480
- 1 MCBCH \$411
- \$7,377**

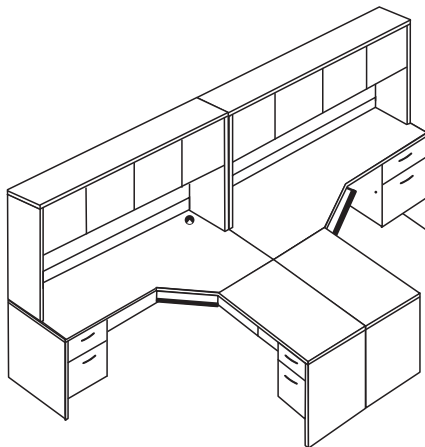

- 1 MCCD72 4R \$1,076
- 1 MCCD72 4L \$1,076
- 1 MCRA2436R \$921
- 1 MCRA2436L \$921
- 2 MCH72WD \$2,480
- \$6,052**

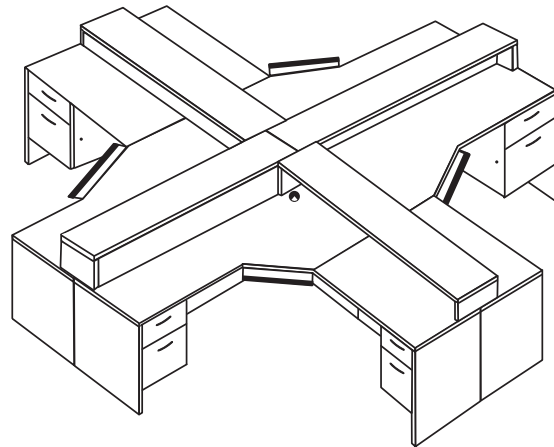

- 2 MCCD72 4R \$2,152
- 2 MCCD72 4L \$2,152
- 2 MCRA2436R \$1,842
- 2 MCRA2436L \$1,842
- 2 MCB66 \$1,112
- 2 MCB72 \$1,242
- \$9,668**

For pricing on other Maverick Series teaming set-ups, contact your sales representative or Customer Service.

Maverick Complete



Desks

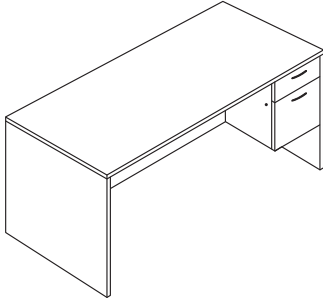

Single Pedestal Desk, Box/File Pedestal (Full modesty, handles, lock), Right

Model#	Depth	Width	Height	Weight	Cube	Price
MCS2042R	20"	42"	29"	120	15	\$822
MCS2060R	20"	60"	29"	150	20	\$876
MCS2066R	20"	66"	29"	156	23	\$974
MCS2072R	20"	72"	29"	163	24	\$985
MCS2442R	24"	42"	29"	127	18	\$850
MCS2448R	24"	48"	29"	130	20	\$865
MCS3048R	30"	48"	29"	142	25	\$876
MCS3060R	30"	60"	29"	190	32	\$890
MCS3066R	30"	66"	29"	197	35	\$985
MCS3072R	30"	72"	29"	210	38	\$1,002
MCS3672R	36"	72"	29"	225	45	\$1,049

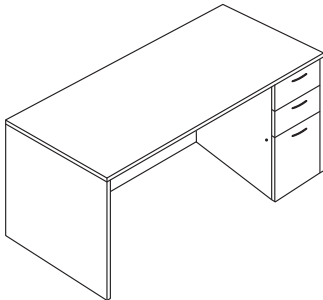

Single Pedestal Desk, Box/Box/File Pedestal (Full modesty, handles, lock), Right

Model#	Depth	Width	Height	Weight	Cube	Price
MCSC2042R	20"	42"	29"	155	15	\$1,191
MCSC2060R	20"	60"	29"	180	20	\$1,244
MCSC2066R	20"	66"	29"	190	23	\$1,343
MCSC2072R	20"	72"	29"	200	24	\$1,356
MCSC2442R	24"	42"	29"	175	18	\$1,220
MCSC2448R	24"	48"	29"	183	20	\$1,234
MCSC3048R	30"	48"	29"	203	25	\$1,244
MCSC3060R	30"	60"	29"	224	32	\$1,259
MCSC3066R	30"	66"	29"	234	35	\$1,356
MCSC3072R	30"	72"	29"	244	38	\$1,370
MCSC3672R	36"	72"	29"	267	45	\$1,418

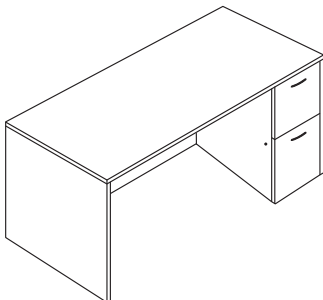

Single Pedestal Desk, File/File Pedestal (Full modesty, handles, lock), Right

Model#	Depth	Width	Height	Weight	Cube	Price
MCSD2042R	20"	42"	29"	155	15	\$1,133
MCSD2060R	20"	60"	29"	180	20	\$1,186
MCSD2066R	20"	66"	29"	190	23	\$1,283
MCSD2072R	20"	72"	29"	200	24	\$1,296
MCSD2442R	24"	42"	29"	175	18	\$1,158
MCSD2448R	24"	48"	29"	183	20	\$1,173
MCSD3048R	30"	48"	29"	203	25	\$1,186
MCSD3060R	30"	60"	29"	224	32	\$1,201
MCSD3066R	30"	66"	29"	234	35	\$1,296
MCSD3072R	30"	72"	29"	244	38	\$1,311
MCSD3672R	36"	72"	29"	267	45	\$1,359



Maverick Complete

Desks

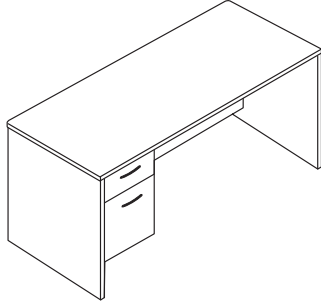

Single Pedestal Desk, Box/File Pedestal (Full modesty, handles, lock), Left

Model#	Depth	Width	Height	Weight	Cube	Price
MCS2042L	20"	42"	29"	120	15	\$822
MCS2060L	20"	60"	29"	150	20	\$876
MCS2066L	20"	66"	29"	156	23	\$974
MCS2072L	20"	72"	29"	163	24	\$985
MCS2442L	24"	42"	29"	127	18	\$850
MCS2448L	24"	48"	29"	130	20	\$865
MCS3048L	30"	48"	29"	142	25	\$876
MCS3060L	30"	60"	29"	190	32	\$890
MCS3066L	30"	66"	29"	197	35	\$985
MCS3072L	30"	72"	29"	210	38	\$1,002
MCS3672L	36"	72"	29"	225	45	\$1,049

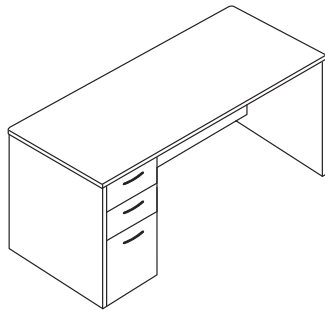

Single Pedestal Desk, Box/Box/File Pedestal (Full modesty, handles, lock), Left

Model#	Depth	Width	Height	Weight	Cube	Price
MCSC2042L	20"	42"	29"	155	15	\$1,191
MCSC2060L	20"	60"	29"	180	20	\$1,244
MCSC2066L	20"	66"	29"	190	23	\$1,343
MCSC2072L	20"	72"	29"	200	24	\$1,356
MCSC2442L	24"	42"	29"	175	18	\$1,220
MCSC2448L	24"	48"	29"	183	20	\$1,234
MCSC3048L	30"	48"	29"	203	25	\$1,259
MCSC3060L	30"	60"	29"	224	32	\$1,259
MCSC3066L	30"	66"	29"	234	35	\$1,356
MCSC3072L	30"	72"	29"	244	38	\$1,370
MCSC3672L	36"	72"	29"	267	45	\$1,418

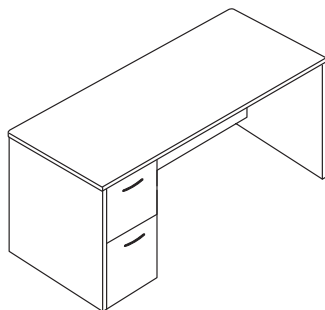

Single Pedestal Desk, File/File Pedestal (Full modesty, handles, lock), Left

Model#	Depth	Width	Height	Weight	Cube	Price
MCSD2042L	20"	42"	29"	155	15	\$1,133
MCSD2060L	20"	60"	29"	180	20	\$1,186
MCSD2066L	20"	66"	29"	190	23	\$1,283
MCSD2072L	20"	72"	29"	200	24	\$1,296
MCSD2442L	24"	42"	29"	175	18	\$1,158
MCSD2448L	24"	48"	29"	183	20	\$1,173
MCSD3048L	30"	48"	29"	203	25	\$1,186
MCSD3060L	30"	60"	29"	224	32	\$1,201
MCSD3066L	30"	66"	29"	234	35	\$1,296
MCSD3072L	30"	72"	29"	244	38	\$1,343
MCSD3672L	36"	72"	29"	267	45	\$1,359

Maverick Complete



Desks

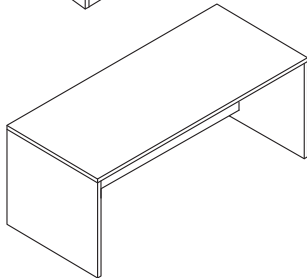
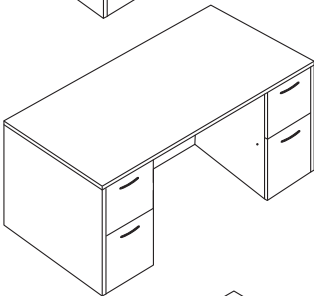
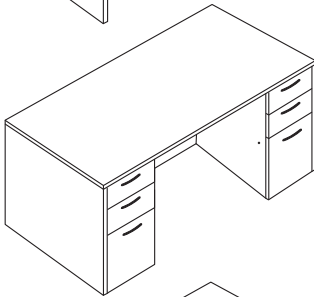
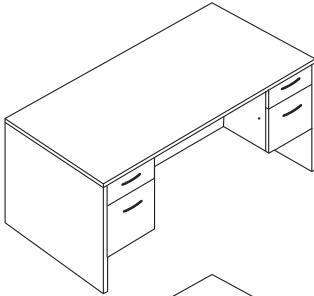

Double Pedestal Desk, Box/File Pedestals (Full modesty), Left and Right

Model#	Depth	Width	Height	Weight	Cube	Price
MCD3060	30"	60"	29"	260	32	\$1,097
MCD3066	30"	66"	29"	266	35	\$1,296
MCD3072	30"	72"	29"	270	38	\$1,316
MCD3672	36"	72"	29"	276	45	\$1,329

Double Pedestal Desk, Box/Box/File Pedestals (Full modesty), Left and Right

Model#	Depth	Width	Height	Weight	Cube	Price
MCDC3060	30"	60"	29"	294	32	\$1,560
MCDC3066	30"	66"	29"	304	35	\$1,805
MCDC3072	30"	72"	29"	314	38	\$1,826
MCDC3672	36"	72"	29"	337	45	\$1,840

Double Pedestal Desk, File/File Pedestals (Full modesty), Left and Right

Model#	Depth	Width	Height	Weight	Cube	Price
MCDD3060	30"	60"	29"	294	32	\$1,480
MCDD3066	30"	66"	29"	304	35	\$1,725
MCDD3072	30"	72"	29"	314	38	\$1,745
MCDD3672	36"	72"	29"	337	45	\$1,759

No-Pedestal Credenza (20"D & 24"D, Full flush modesty)

Model#	Depth	Width	Height	Weight	Cube	Price
MCN2042	20"	42"	29"	84	17	\$479
MCN2048	20"	48"	29"	84	17	\$493
MCN2060	20"	60"	29"	92	20	\$528
MCN2066	20"	66"	29"	96	23	\$562
MCN2072	20"	72"	29"	100	24	\$576
MCN2436	24"	36"	29"	89	16	\$485
MCN2442	24"	42"	29"	95	18	\$528
MCN2448	24"	48"	29"	104	20	\$541
MCN2460	24"	60"	29"	120	25	\$576
MCN2466	24"	66"	29"	127	28	\$643
MCN2472	24"	72"	29"	132	30	\$685

No-Pedestal Desk (Inset Modesty...30"D-6" Inset Modesty, 36"D-12" Inset Modesty)

Model#	Depth	Width	Height	Weight	Cube	Price
MCN3042	30"	42"	29"	114	22	\$576
MCN3048	30"	48"	29"	120	25	\$590
MCN3060	30"	60"	29"	126	32	\$605
MCN3066	30"	66"	29"	132	35	\$664
MCN3072	30"	72"	29"	138	38	\$685
MCN3672	36"	72"	29"	152	45	\$699



For left or right 1/2 leg specify on order...N/C. For full modesty panel upgrade, add MMFMP...\$59.
For fan top desk, add upgrade MMFAN...\$261 (Center depth increases by 6")

See available accessories and upgrades, pp. 102-106



Maverick Complete

Desks

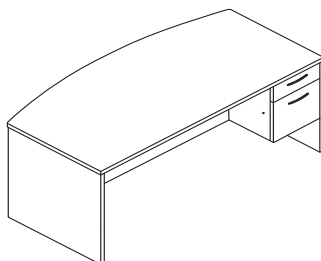

Fan Top Single Pedestal Conference Desk, Box/File Pedestal (Full modesty), Right

	Model#	Depth	Width	Height	Weight	Cube	Price
	MCFS3672R	30-36"	72"	29"	233	45	\$1,268
	MCFS4272R	36-42"	72"	29"	258	53	\$1,309

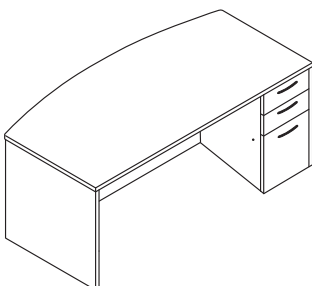

Fan Top Single Pedestal Conference Desk, Box/Box/File Pedestal (Full modesty), Right

	Model#	Depth	Width	Height	Weight	Cube	Price
	MCFSC3672R	30-36"	72"	29"	265	45	\$1,637
	MCFSC4272R	36-42"	72"	29"	280	53	\$1,678

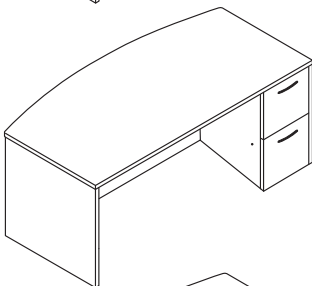

Fan Top Single Pedestal Conference Desk, File/File Pedestal (Full modesty), Right

	Model#	Depth	Width	Height	Weight	Cube	Price
	MCFSD3672R	30-36"	72"	29"	265	45	\$1,577
	MCFSD4272R	36-42"	72"	29"	280	53	\$1,617

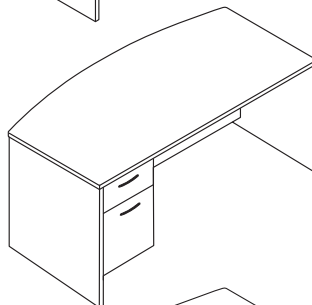

Fan Top Single Pedestal Conference Desk, Box/File Pedestal (Full modesty), Left

	Model#	Depth	Width	Height	Weight	Cube	Price
	MCFS3672L	30-36"	72"	29"	233	45	\$1,268
	MCFS4272L	36-42"	72"	29"	258	53	\$1,309

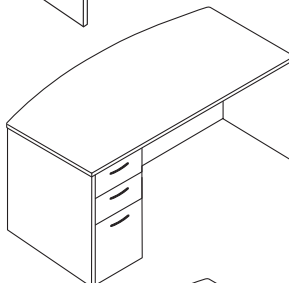

Fan Top Single Pedestal Conference Desk, Box/Box/File Pedestal (Full modesty), Left

	Model#	Depth	Width	Height	Weight	Cube	Price
	MCFSC3672L	30-36"	72"	29"	265	45	\$1,637
	MCFSC4272L	36-42"	72"	29"	280	53	\$1,678

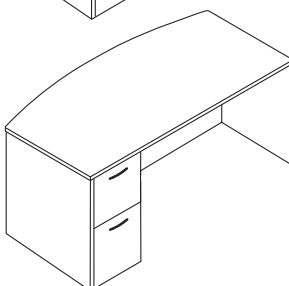

Fan Top Single Pedestal Conference Desk, File/File Pedestal (Full modesty), Left

	Model#	Depth	Width	Height	Weight	Cube	Price
	MCFSD3672L	30-36"	72"	29"	265	45	\$1,577
	MCFSD4272L	36-42"	72"	29"	280	53	\$1,617

Maverick Complete



Desks

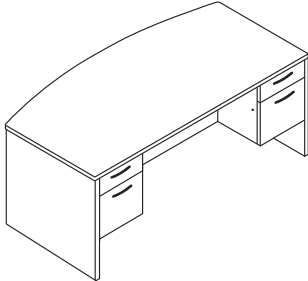

Fan Top Double Pedestal Conference Desk, Box/File Pedestals (Full modesty),
Left and Right

	Model#	Depth	Width	Height	Weight	Cube	Price
Qs	MCFD3672	30-36"	72"	29"	280	45	\$1,571
Qs	MCFD4272	36-42"	72"	29"	305	53	\$1,584

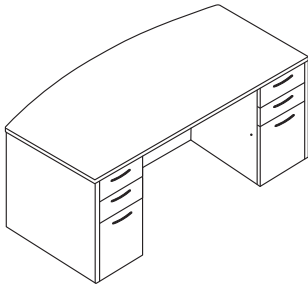

Fan Top Double Pedestal Conference Desk, Box/Box/File Pedestals (Full modesty),
Left and Right

	Model#	Depth	Width	Height	Weight	Cube	Price
Qs	MCFDC3672	30-36"	72"	29"	335	45	\$2,034
Qs	MCFDC4272	36-42"	72"	29"	350	53	\$2,047

For File/File, Box/Box/File configuration please specify...N/C.

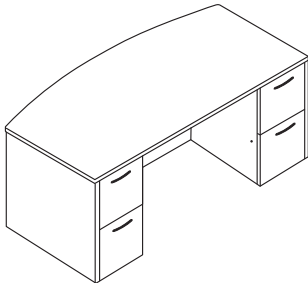

Fan Top Double Pedestal Conference Desk, File/File Pedestals (Full modesty),
Left and Right

	Model#	Depth	Width	Height	Weight	Cube	Price
Qs	MCFDD3672	30-36"	72"	29"	335	45	\$1,953
Qs	MCFDD4272	36-42"	72"	29"	350	53	\$1,965

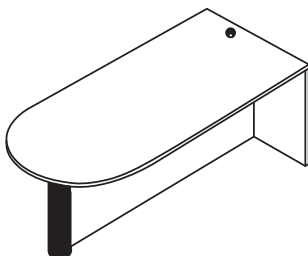

Bullet Desk, (Full modesty, 4" black post, centered grommet)

	Model#	Depth	Width	Height	Weight	Cube	Price
Qs	MCBD3060	30"	60"	29"	180	32	\$843
Qs	MCBD3072	30"	72"	29"	195	35	\$952
Qs	MCBD3660	36"	60"	29"	185	38	\$952
Qs	MCBD3672	36"	72"	29"	205	45	\$1,007

For silver post upgrade, add MM UHLEGJS...\$26. Set-up for left or right connection.



Maverick Complete

Desks

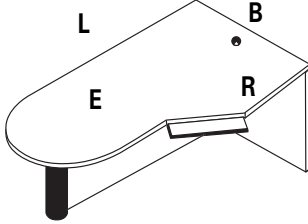

Bullet Computer Desk (Full modesty, 4" black post), For Right Return

	Model#	Depth (B,E)	Width (L,R)	Height	Weight	Cube	Price
	MCBDC427230R	42/30"	72"/24"	29"	195	53	\$1,028
	MCBDC427830R	42/30"	78"/24"	29"	205	58	\$1,248

Keyboard tray and worksurface black grommet are standard. Upgrade grommet cover to silver, N/C.
For silver post upgrade, add MM UHLEGJS...\$26.

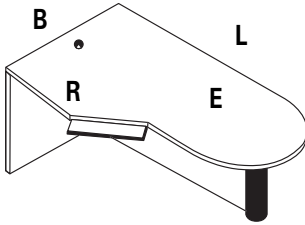

Bullet Computer Desk (Full modesty, 4" black post), For Left Return

	Model#	Depth (B,E)	Width (L,R)	Height	Weight	Cube	Price
	MCBDC427230L	42/30"	72"/24"	29"	195	53	\$1,028
	MCBDC427830L	42/30"	78"/24"	29"	205	58	\$1,248

Keyboard tray and worksurface black grommet are standard. Upgrade grommet cover to silver, N/C.
For silver post upgrade, add MM UHLEGJS...\$26.

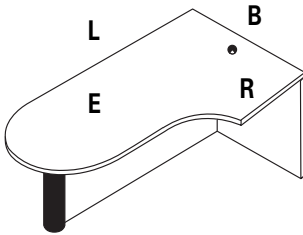

Bullet Computer Desk, Curved (Full modesty, 4" black post), For Right Return

	Model#	Depth (B,E)	Width (L,R)	Height	Weight	Cube	Price
	MCBDCQ427230R	42/30"	72"/24"	29"	195	53	\$1,028

Worksurface black grommet standard. Upgrade grommet cover to silver, N/C.
For silver post upgrade, add MM UHLEGJS...\$26.

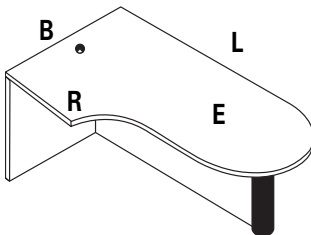

Bullet Computer Desk, Curved (Full modesty, 4" black post), For Left Return

	Model#	Depth (B,E)	Width (L,R)	Height	Weight	Cube	Price
	MCBDCQ427230L	42/30"	72"/24"	29"	195	53	\$1,028

Worksurface black grommet standard. Upgrade grommet cover to silver, N/C.
For silver post upgrade, add MM UHLEGJS...\$26.

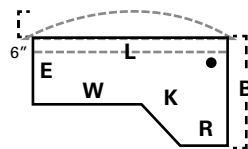

- "L" Length along approach edge
- "B" Back end panel (Fan top adds 6")
- "E" End panel
- "K" Keyboard space
- "R" Return size to attach
- "W" Workarea (kbrd to end)

Maverick Complete



Desks

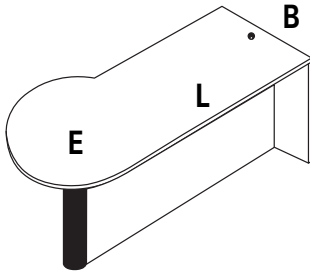

P-shape Desk (Full modesty, 4" black post), For Right Return

Model#	Depth (B,E)	Width (L)	Height	Weight	Cube	Price
MCPBD3072R	30/36"	72"	29"	200	45	\$1,137
MCPBD3672R	36/42"	72"	29"	205	53	\$1,193
MCPBD3678R	36/42"	78"	29"	215	49	\$1,289
MCPBD3684R	36/42"	84"	29"	225	62	\$1,474

For silver post upgrade, add MM UHLEGJS...\$26.

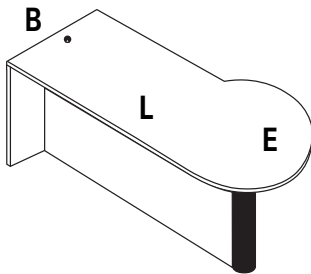

P-shape Desk (Full modesty, 4" black post), For Left Return

Model#	Depth (B,E)	Width (L)	Height	Weight	Cube	Price
MCPBD3072L	30/36"	72"	29"	200	45	\$1,137
MCPBD3672L	36/42"	72"	29"	205	53	\$1,193
MCPBD3678L	36/42"	78"	29"	215	49	\$1,289
MCPBD3684L	36/42"	84"	29"	225	62	\$1,474

For silver post upgrade, add MM UHLEGJS...\$26.

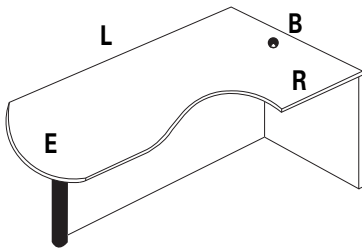

Arc End Computer Desk (Full modesty, 4" black post), For Right Return

Model#	Depth (B,E)	Width (L,R)	Height	Weight	Cube	Price
MCAE427236R	42/36"	72"/24"	29"	205	53	\$1,262
MCAE427836R	42/36"	78"/24"	29"	215	58	\$1,366

Black grommet standard. Upgrade grommet cover to silver, N/C. For silver post upgrade, add MM UHLEGJS...\$26.

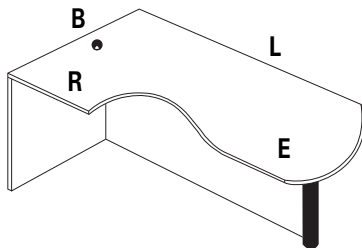

Arc End Computer Desk (Full modesty, 4" black post), For Left Return

Model#	Depth (B,E)	Width (L,R)	Height	Weight	Cube	Price
MCAE427236L	42/36"	72"/24"	29"	205	53	\$1,262
MCAE427836L	42/36"	78"/24"	29"	215	58	\$1,366

Black grommet standard. Upgrade grommet cover to silver, N/C. For silver post upgrade, add MM UHLEGJS...\$26.

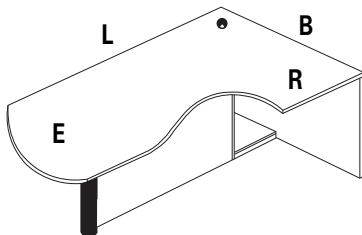

Arc End Computer Desk w/CPU Storage Cabinet (Full modesty, 4" black post), For Right Return

Model#	Depth (B,E)	Width (L,R)	Height	Weight	Cube	Price
MCAEC427236R	42/36"	72"/24"	29"	205	53	\$1,364
MCAEC427836R	42/36"	78"/24"	29"	215	58	\$1,554

Black grommet standard. Upgrade grommet cover to silver, N/C. For silver post upgrade, add MM UHLEGJS...\$26.

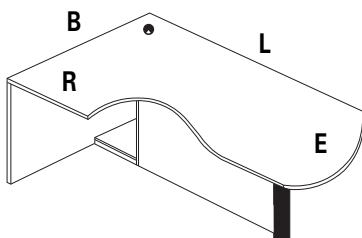

Arc End Computer Desk w/CPU Storage Cabinet (Full modesty, 4" black post), For Left Return

Model#	Depth (B,E)	Width (L,R)	Height	Weight	Cube	Price
MC AEC427236L	42/36"	72"/24"	29"	205	53	\$1,364
MCAEC427836L	42/36"	78"/24"	29"	215	58	\$1,554

Black grommet standard. Upgrade grommet cover to silver, N/C. For silver post upgrade, add MM UHLEGJS...\$26.

See available accessories and upgrades, pp. 102-106



Maverick Complete

Desks

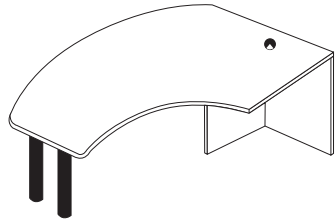

Desk, Wedge Bullet Curve (Two black 2" post legs, black grommet), For Right Return

Model#	(L)	(B)	(E)	(K)	(R)	(W)	Weight	Cube	Price
MMBWQ3672R	72"	36"+	24"	24"	24"	27"	215	45	\$1,083

Worksurface black grommet standard. No keyboard tray. Upgrade grommet color to silver, N/C.
For silver post upgrade, add MM UHLEGLS...\$13 each.

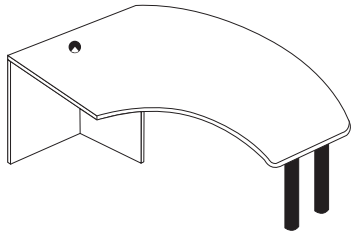

Desk, Wedge Bullet Curve (Two black 2" post legs, black grommet), For Left Return

Model#	(L)	(B)	(E)	(K)	(R)	(W)	Weight	Cube	Price
MMBWQ3672L	72"	36"+	24"	24"	24"	27"	215	45	\$1,083

Worksurface black grommet standard. No keyboard tray. Upgrade grommet color to silver, N/C.
For silver post upgrade, add MM UHLEGLS...\$13 each.

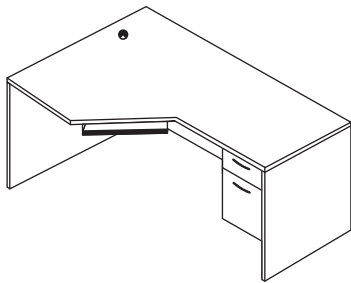

Computer Desk, Box/File Pedestal (Front unit, full modesty inset 6"), Right

Model#	(L)	(B)	(E)	(K)	(R)	(W)	Weight	Cube	Price
MCCD72 9R	72"	42"	30"	24"	24"	27"	285	45	\$1,447

Keyboard tray and worksurface black grommet are standard. Upgrade grommet cover to silver, N/C.

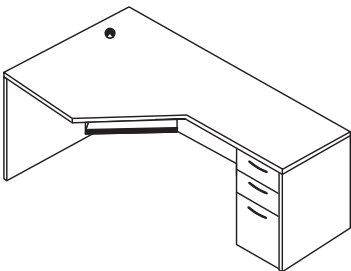

Computer Desk, Box/Box/File Pedestal (Front unit, full modesty inset 6"), Right

Model#	(L)	(B)	(E)	(K)	(R)	(W)	Weight	Cube	Price
MCCD72C 9R	72"	42"	30"	24"	24"	27"	300	45	\$1,816

Keyboard tray and worksurface black grommet are standard. Upgrade grommet cover to silver, N/C.

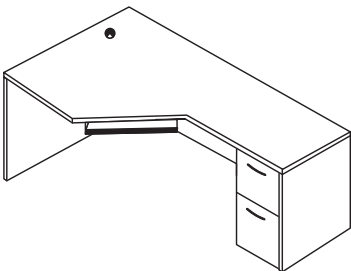

Computer Desk, File/File Pedestal (Front unit, full modesty inset 6"), Right

Model#	(L)	(B)	(E)	(K)	(R)	(W)	Weight	Cube	Price
MCCD72D 9R	72"	42"	30"	24"	24"	27"	300	45	\$1,757

Keyboard tray and worksurface black grommet are standard. Upgrade grommet cover to silver, N/C.

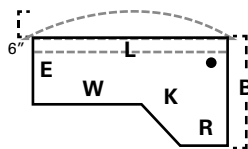

- "L" Length along approach edge
- "B" Back end panel (Fan top adds 6")
- "E" End panel
- "K" Keyboard space
- "R" Return size to attach
- "W" Workarea (kbrd to end)

Maverick Complete



Desks

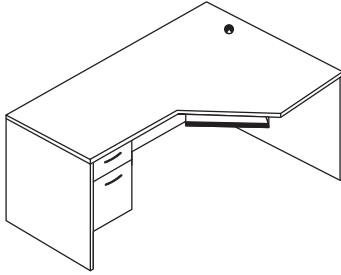

Computer Desk, Box/File Pedestal (Front unit, Full modesty inset 6"), Left

Model#	(L)	(B)	(E)	(K)	(R)	(W)	Weight	Cube	Price
MCCD72 9L	72"	42"	30"	24"	24"	27"	285	45	\$1,447

Keyboard tray and worksurface black grommet are standard. Upgrade grommet cover to silver, N/C.

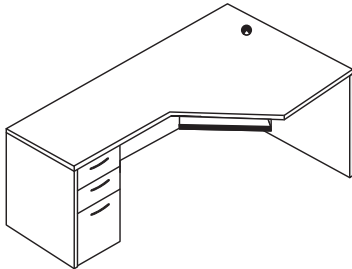

Computer Desk, Box/Box/File Pedestal (Front unit, Full modesty inset 6"), Left

Model#	(L)	(B)	(E)	(K)	(R)	(W)	Weight	Cube	Price
MCCD72C 9L	72"	42"	30"	24"	24"	27"	300	45	\$1,816

Keyboard tray and worksurface black grommet are standard. Upgrade grommet cover to silver, N/C.

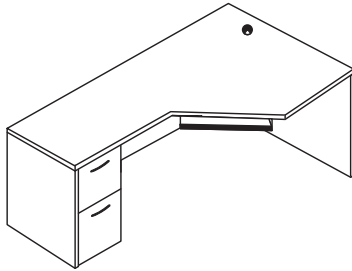

Computer Desk, File/File Pedestal (Front unit, Full modesty inset 6"), Left

Model#	(L)	(B)	(E)	(K)	(R)	(W)	Weight	Cube	Price
MCCD72D 9L	72"	42"	30"	24"	24"	27"	300	45	\$1,757

Keyboard tray and worksurface black grommet are standard. Upgrade grommet cover to silver, N/C.

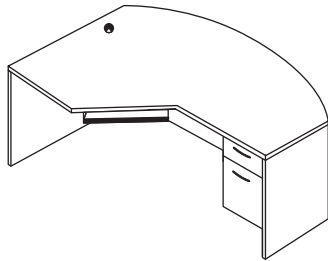

Fan Top Computer Desk, Box/File Pedestal (Front unit, Full modesty inset 6"), Right

Model#	(L)	(B)	(E)	(K)	(R)	(W)	Weight	Cube	Price
MCFC72 9R	72"	42"+	30"	24"	24"	27"	295	48	\$1,549

Keyboard tray and worksurface black grommet are standard. Fan front adds 6" to overall depth. Upgrade grommet cover to silver, N/C.

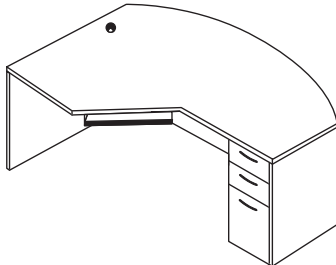

Fan Top Computer Desk, Box/Box/File Pedestal, (Front Unit, full modesty inset 6"), Right

Model#	(L)	(B)	(E)	(K)	(R)	(W)	Weight	Cube	Price
MCFC72C 9R	72"	42"+	30"	24"	24"	27"	310	48	\$1,920

Keyboard tray and worksurface black grommet are standard. Fan front adds 6" to overall depth. Upgrade grommet cover to silver, N/C.

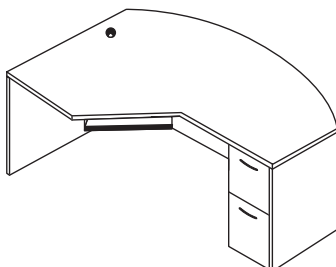

Fan Top Computer Desk, File/File Pedestal (Front Unit, full modesty inset 6"), Right

Model#	(L)	(B)	(E)	(K)	(R)	(W)	Weight	Cube	Price
MCFC72D 9R	72"	42"+	30"	24"	24"	27"	310	48	\$1,859

Keyboard tray and worksurface black grommet are standard. Fan front adds 6" to overall depth. Upgrade grommet cover to silver, N/C.



Maverick Complete

Desks

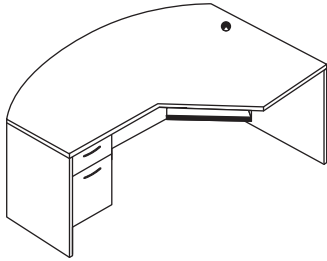

Fan Top Computer Desk, Box/File Pedestal (Front unit, Full modesty inset 6"), Left

Model#	(L)	(B)	(E)	(K)	(R)	(W)	Weight	Cube	Price
MCFC72 9L	72"	42"+	30"	24"	24"	27"	295	48	\$1,549

Keyboard tray and worksurface black grommet are standard. Upgrade grommet cover to silver, N/C.
Fan front adds 6" to overall depth.

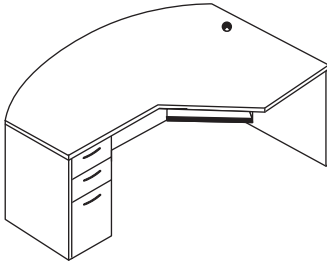

Fan Top Computer Desk, Box/Box/File Pedestal (Front unit, Full modesty inset 6"), Left

Model#	(L)	(B)	(E)	(K)	(R)	(W)	Weight	Cube	Price
MCFC72C 9L	72"	42"+	30"	24"	24"	27"	310	48	\$1,920

Keyboard tray and worksurface black grommet are standard. Upgrade grommet cover to silver, N/C.
Fan front adds 6" to overall depth.

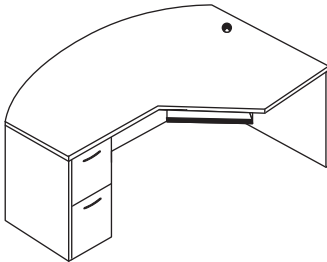

Fan Top Computer Desk, File/File Pedestal (Front unit, Full modesty inset 6"), Left

Model#	(L)	(B)	(E)	(K)	(R)	(W)	Weight	Cube	Price
MCFC72D 9L	72"	42"+	30"	24"	24"	27"	310	48	\$1,859

Keyboard tray and worksurface black grommet are standard. Upgrade grommet cover to silver, N/C.
Fan front adds 6" to overall depth.

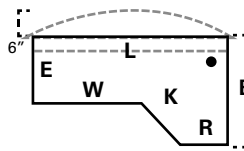

- "L" Length along approach edge
- "B" Back end panel (Fan top adds 6")
- "E" End panel
- "K" Keyboard space
- "R" Return size to attach
- "W" Workarea (kbrd to end)

Maverick Complete



Desks

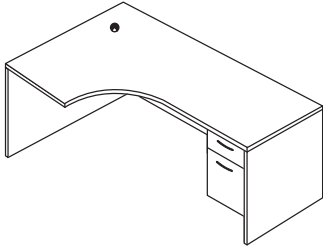

Computer Desk, Curved, Box/File Pedestal (Front unit, Full modesty inset 6"), Right

Model#	(L)	(B)	(E)	(K)	(R)	(W)	Weight	Cube	Price
MCCDQ72 9R	72"	42"	30"	24"	24"	27"	285	45	\$1,447

No keyboard tray. Worksurface black grommet standard. Upgrade grommet cover to silver, N/C.

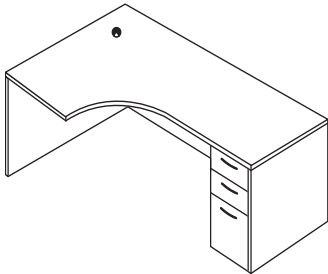

Computer Desk, Curved, Box/Box/File Pedestal (Front unit, Full modesty inset 6"), Right

Model#	(L)	(B)	(E)	(K)	(R)	(W)	Weight	Cube	Price
MCCDQ72C 9R	72"	42"	30"	24"	24"	27"	300	45	\$1,816

No keyboard tray. Worksurface black grommet standard. Upgrade grommet cover to silver, N/C.

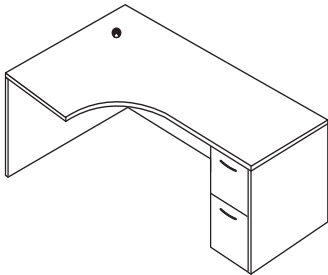

Computer Desk, Curved, File/File Pedestal (Front unit, Full modesty inset 6"), Right

Model#	(L)	(B)	(E)	(K)	(R)	(W)	Weight	Cube	Price
MCCDQ72D 9R	72"	42"	30"	24"	24"	27"	300	45	\$1,757

No keyboard tray. Worksurface black grommet standard. Upgrade grommet cover to silver, N/C.

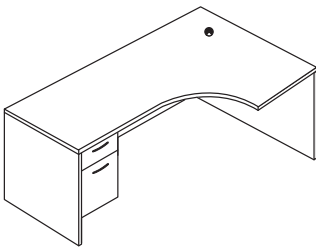

Computer Desk, Curved, Box/File Pedestal (Front unit, Full modesty inset 6"), Left

Model#	(L)	(B)	(E)	(K)	(R)	(W)	Weight	Cube	Price
MCCDQ72 9L	72"	42"	30"	24"	24"	27"	285	45	\$1,447

No keyboard tray. Worksurface black grommet standard. Upgrade grommet cover to silver, N/C.

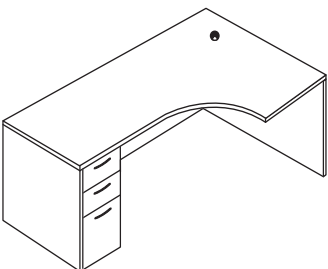

Computer Desk, Curved, Box/Box/File Pedestal (Front unit, Full modesty inset 6"), Left

Model#	(L)	(B)	(E)	(K)	(R)	(W)	Weight	Cube	Price
MCCDQ72C 9L	72"	42"	30"	24"	24"	27"	300	45	\$1,816

No keyboard tray. Worksurface black grommet standard. Upgrade grommet cover to silver, N/C.

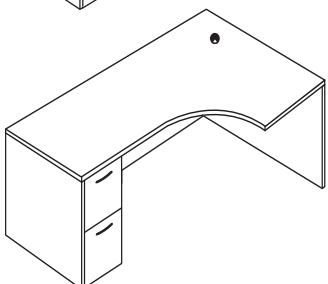

Computer Desk, Curved, File/File Pedestal (Front unit, Full modesty inset 6"), Left

Model#	(L)	(B)	(E)	(K)	(R)	(W)	Weight	Cube	Price
MCCDQ72D 9L	72"	42"	30"	24"	24"	27"	300	45	\$1,757

No keyboard tray. Worksurface black grommet standard. Upgrade grommet cover to silver, N/C.



Maverick Complete

Desks

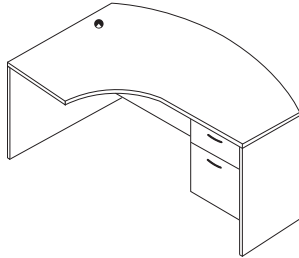

Fan Top Computer Desk, Curved, Box/File Pedestal (Front unit, Full modesty inset 6\"/>

Model#	(L)	(B)	(E)	(K)	(R)	(W)	Weight	Cube	Price
MCFCDQ72 9R	72"	42"+	30"	24"	24"	27"	295	48	\$1,549

No keyboard tray. Worksurface black grommet standard. Fan front adds 6" to overall depth.
Upgrade grommet cover to silver, N/C.

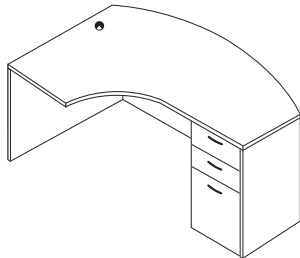

Fan Top Computer Desk, Curved, Box/Box/File Pedestal (Front unit, Full modesty inset 6\"/>

Model#	(L)	(B)	(E)	(K)	(R)	(W)	Weight	Cube	Price
MCFCDQ72C 9R	72"	42"+	30"	24"	24"	27"	310	48	\$1,920

No keyboard tray, worksurface black grommet standard. Fan front adds 6" to overall depth.
Upgrade grommet cover to silver, N/C.

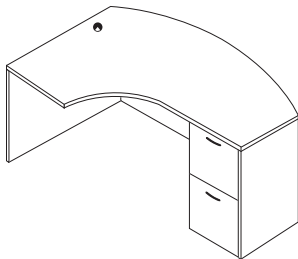

Fan Top Computer Desk, Curved, File/File Pedestal (Front unit, Full modesty inset 6\"/>

Model#	(L)	(B)	(E)	(K)	(R)	(W)	Weight	Cube	Price
MCFCDQ72D 9R	72"	42"+	30"	24"	24"	27"	310	48	\$1,859

No keyboard tray, worksurface black grommet standard. Fan front adds 6" to overall depth.
Upgrade grommet cover to silver, N/C.

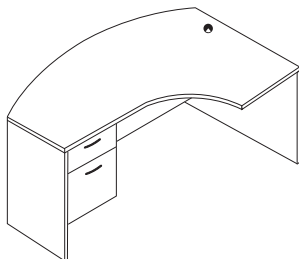

Fan Top Computer Desk, Curved, Box/File Pedestal (Front Unit, Full modesty inset 6\"/>

Model#	(L)	(B)	(E)	(K)	(R)	(W)	Weight	Cube	Price
MCFCDQ72 9L	72"	42"+	30"	24"	24"	27"	295	48	\$1,549

No Keyboard tray, worksurface black grommet standard. Fan front adds 6" to overall depth.
Upgrade grommet cover to silver, N/C.

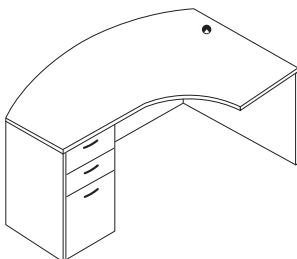

Fan Top Computer Desk, Curved, Box/Box/File Pedestal (Front unit, Full modesty inset 6\"/>

Model#	(L)	(B)	(E)	(K)	(R)	(W)	Weight	Cube	Price
MCFCDQ72C 9L	72"	42"+	30"	24"	24"	27"	310	48	\$1,920

No keyboard tray. Worksurface black grommet standard. Fan front adds 6" to overall depth.
Upgrade grommet cover to silver, N/C.

Maverick Complete



Desks

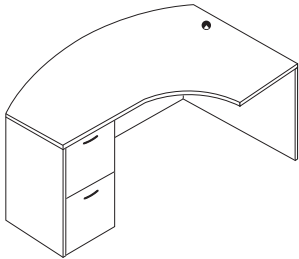

Fan Top Computer Desk, Curved, File/File Pedestal (Front unit, Full modesty inset 6''), Left

Model#	(L)	(B)	(E)	(K)	(R)	(W)	Weight	Cube	Price
MCFCDO72D 9L	72"	42"+ 30"	24"	24"	27"	310	48	\$1,859	

No keyboard tray worksurface black grommet standard. Fan front adds 6" to overall depth.
Upgrade grommet cover to silver, N/C. .

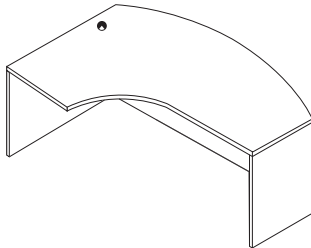

Fan Top Computer Desk Shell, Curved (Front unit, Full modesty inset 6''), For Left Return

Model#	(L)	(B)	(E)	(K)	(R)	(W)	Weight	Cube	Price
MCFCDNQ72 9L	72"	42"+ 30"	24"	24"	27"	215	48	\$1,179	

No keyboard tray. Worksurface black grommet standard. Upgrade grommet cover to silver, N/C.
Fan front adds 6" to overall depth.

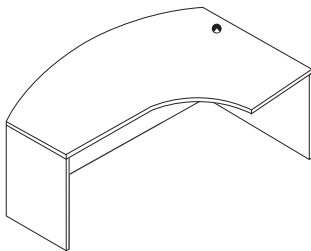

Fan Top Computer Desk Shell, Curved (Front unit, Full modesty inset 6''), For Right Return

Model#	(L)	(B)	(E)	(K)	(R)	(W)	Weight	Cube	Price
MCFCDNQ72 9R	72"	42"+ 30"	24"	24"	27"	215	48	\$1,179	

No keyboard tray. Worksurface black grommet standard. Upgrade grommet cover to silver, N/C.
Fan front adds 6" to overall depth.

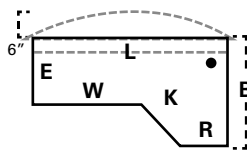

"L" Length along approach edge
"B" Back end panel (Fan top adds 6")
"E" End panel
"K" Keyboard space
"R" Return size to attach
"W" Workarea (kbrd to end)

CompuCorner Units

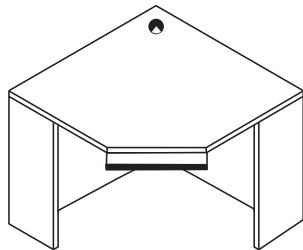

Computer Corner Unit (Full modesty), Component

Model#	Depth	Width	Return	Height	Weight	Cube	Price
*MCCCU363620	36"	36"	20"	29"	165	23	\$774
*MCCCU363624	36"	36"	24"	29"	180	23	\$774
MCCCU424220	42"	42"	20"	29"	180	31	\$953
MCCCU424224	42"	42"	24"	29"	180	31	\$953
MCCCU484824	48"	48"	24"	29"	195	40	\$1,028
MCCCU484830	48"	48"	30"	29"	195	40	\$1,028

Keyboard tray and worksurface black grommet are standard. *Keyboard tray is shipped uninstalled to be added after returns are attached. Upgrade grommet color to silver, N/C.

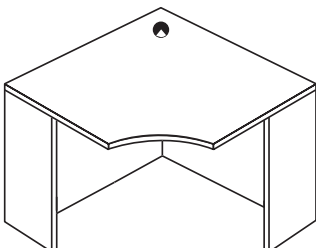

Computer Corner Unit, Curved (Full modesty), Component

Model#	Depth	Width	Return	Height	Weight	Cube	Price
MCCCUQ363620	36"	36"	20"	29"	180	31	\$774
MCCCUQ363624	36"	36"	24"	29"	180	31	\$774
MCCCUQ424220	42"	42"	20"	29"	180	31	\$953
MCCCUQ424224	42"	42"	24"	29"	180	31	\$953

Worksurface black grommet are standard. Upgrade grommet color to silver, N/C. No keyboard.



Maverick Complete

Bridges, Returns

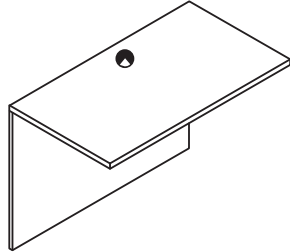

Bridge Section (Full modesty, flush height), Component

Model#	Depth	Width	Height	Weight	Cube	Price
MCBR2036	20"	36"	29"	41	9	\$363
MCBR2042	20"	42"	29"	48	10	\$378
MCBR2048	20"	48"	29"	55	12	\$419
MCBR2436	24"	36"	29"	47	10	\$393
MCBR2442	24"	42"	29"	55	12	\$460
MCBR2448	24"	48"	29"	63	14	\$501
MCBR2460	24"	60"	29"	78	15	\$578

Full modesty standard. ½ modesty on bridges may be specified at no upcharge.

Returns

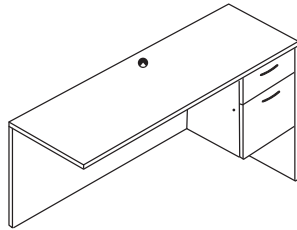

Return, ¾ Box/File Pedestal (Full modesty, flush height), Right

Model#	Depth	Width	Height	Weight	Cube	Price
MCRA2036R	20"	36"	29"	95	13	\$830
MCRA2042R	20"	42"	29"	104	15	\$843
MCRA2048R	20"	48"	29"	110	17	\$858
MCRA2054R	20"	54"	29"	117	19	\$885
MCRA2436R	24"	36"	29"	100	15	\$921
MCRA2442R	24"	42"	29"	107	18	\$948
MCRA2448R	24"	48"	29"	114	20	\$960
MCRA2454R	24"	54"	29"	121	23	\$1,017
MCRA2460R	24"	60"	29"	124	24	\$1,029
MCRA3048R	30"	48"	29"	127	25	\$1,029

Full modesty standard. ½ modesty on returns may be specified at no upcharge.

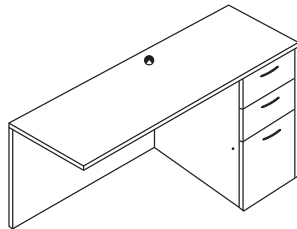

Return, Box/Box/File Pedestal (Full modesty), Right

Model#	Depth	Width	Height	Weight	Cube	Price
MCRC2036R	20"	36"	29"	130	13	\$1,201
MCRC2042R	20"	42"	29"	140	15	\$1,212
MCRC2048R	20"	48"	29"	150	17	\$1,227
MCRC2054R	20"	54"	29"	160	19	\$1,255
MCRC2436R	24"	36"	29"	140	15	\$1,289
MCRC2442R	24"	42"	29"	150	18	\$1,317
MCRC2448R	24"	48"	29"	160	20	\$1,328
MCRC2454R	24"	54"	29"	170	23	\$1,386
MCRC2460R	24"	60"	29"	180	24	\$1,398
MCRC3048R	30"	48"	29"	175	25	\$1,398

Full modesty standard. ½ modesty on returns may be specified at no upcharge.

Maverick Complete



Returns

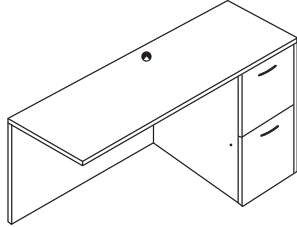

Return, File/File Pedestal (Full modesty), Right

	Model#	Depth	Width	Height	Weight	Cube	Price
Qs	MCRD2036R	20"	36"	29"	130	13	\$1,140
Qs	MCRD2042R	20"	42"	29"	140	15	\$1,152
Qs	MCRD2048R	20"	48"	29"	150	17	\$1,167
Qs	MCRD2054R	20"	54"	29"	160	19	\$1,195
Qs	MCRD2436R	24"	36"	29"	140	15	\$1,231
Qs	MCRD2442R	24"	42"	29"	150	18	\$1,245
Qs	MCRD2448R	24"	48"	29"	160	20	\$1,269
Qs	MCRD2454R	24"	54"	29"	170	23	\$1,326
Qs	MCRD2460R	24"	60"	29"	180	24	\$1,338
Qs	MCRD3048R	30"	48"	29"	175	25	\$1,338

Full modesty standard. ½ modesty on returns may be specified at no upcharge.

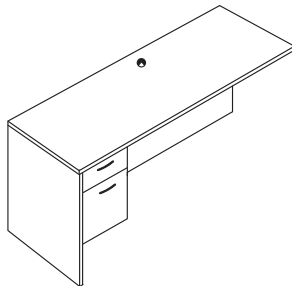

Return, ¾ Box/File Pedestal (Full modesty), Left

	Model#	Depth	Width	Height	Weight	Cube	Price
Qs	MCRA2036L	20"	36"	29"	95	13	\$830
Qs	MCRA2042L	20"	42"	29"	104	15	\$843
Qs	MCRA2048L	20"	48"	29"	110	17	\$858
Qs	MCRA2054L	20"	54"	29"	117	19	\$885
Qs	MCRA2436L	24"	36"	29"	100	15	\$921
Qs	MCRA2442L	24"	42"	29"	107	18	\$948
Qs	MCRA2448L	24"	48"	29"	114	20	\$960
Qs	MCRA2454L	24"	54"	29"	121	23	\$1,017
Qs	MCRA2460L	24"	60"	29"	124	24	\$1,029
Qs	MCRA3048L	30"	48"	29"	127	25	\$1,029

Full modesty standard. ½ modesty on returns may be specified at no upcharge.

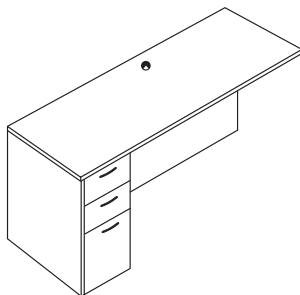

Return, Box/Box/File Pedestal (Full modesty), Left

	Model#	Depth	Width	Height	Weight	Cube	Price
Qs	MCRC2036L	20"	36"	29"	130	13	\$1,201
Qs	MCRC2042L	20"	42"	29"	140	15	\$1,211
Qs	MCRC2048L	20"	48"	29"	150	17	\$1,227
Qs	MCRC2054L	20"	54"	29"	160	19	\$1,255
Qs	MCRC2436L	24"	36"	29"	140	15	\$1,289
Qs	MCRC2442L	24"	42"	29"	150	18	\$1,317
Qs	MCRC2448L	24"	48"	29"	160	20	\$1,328
Qs	MCRC2454L	24"	54"	29"	170	23	\$1,386
Qs	MCRC2460L	24"	60"	29"	180	24	\$1,398
Qs	MCRC3048L	30"	48"	29"	175	25	\$1,398

Full modesty standard. ½ modesty on returns may be specified at no upcharge.

See available accessories and upgrades, pp. 102-106



Maverick Complete

Returns

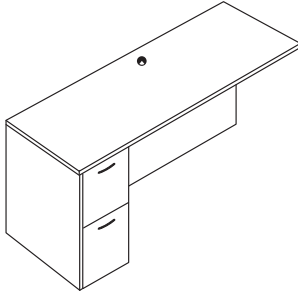

Return, File/File Pedestal (Full modesty), Left

Model#	Depth	Width	Height	Weight	Cube	Price
MCRD2036L	20"	36"	29"	130	13	\$1,140
MCRD2042L	20"	42"	29"	140	15	\$1,152
MCRD2048L	20"	48"	29"	150	17	\$1,167
MCRD2054L	20"	54"	29"	160	19	\$1,195
MCRD2436L	24"	36"	29"	140	15	\$1,231
MCRD2442L	24"	42"	29"	150	18	\$1,245
MCRD2448L	24"	48"	29"	160	20	\$1,269
MCRD2454L	24"	54"	29"	170	23	\$1,326
MCRD2460L	24"	60"	29"	180	24	\$1,338
MCRD3048L	30"	48"	29"	175	25	\$1,338

Full modesty standard. ½ modesty on returns may be specified at no upcharge.

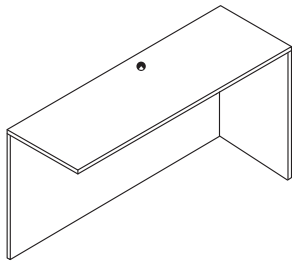

Return Shell (Full modesty, Flush height), Right

Model#	Depth	Width	Height	Weight	Cube	Price
MCRN2036R	20"	36"	29"	60	13	\$460
MCRN2042R	20"	42"	29"	67	15	\$472
MCRN2048R	20"	48"	29"	73	17	\$520
MCRN2054R	20"	54"	29"	80	19	\$563
MCRN2442R	24"	42"	29"	67	18	\$597
MCRN2448R	24"	48"	29"	74	20	\$625
MCRN2454R	24"	54"	29"	80	23	\$659
MCRN3048R	30"	48"	29"	89	25	\$699

Full modesty standard. ½ modesty on returns may be specified at no upcharge.

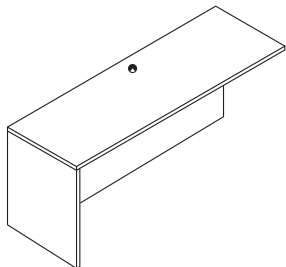

Return Shell (Full modesty, Flush height), Left

Model#	Depth	Width	Height	Weight	Cube	Price
MCRN2036L	20"	36"	29"	60	13	\$460
MCRN2042L	20"	42"	29"	67	15	\$472
MCRN2048L	20"	48"	29"	73	17	\$520
MCRN2054L	20"	54"	29"	80	19	\$563
MCRN2442L	24"	42"	29"	67	18	\$597
MCRN2448L	24"	48"	29"	74	20	\$625
MCRN2454L	24"	54"	29"	80	23	\$659
MCRN3048L	30"	48"	29"	89	25	\$699

Full modesty standard. ½ modesty on returns may be specified at no upcharge.

Maverick Complete



Returns

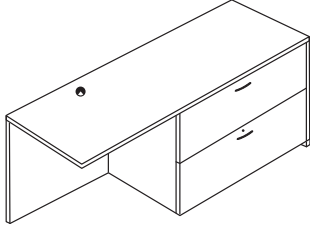

Return, 31" Lateral File (H3B handles, lock, full modesty), Right

Model#	Depth	Width	Height	Weight	Cube	Price
MCRLF2054R	20"	54"	29"	192	19	\$1,331
MCRLF2060R	20"	60"	29"	198	21	\$1,352
MCRLF2072R	20"	72"	29"	212	25	\$1,462
MCRLF2454R	24"	54"	29"	201	23	\$1,407
MCRLF2460R	24"	60"	29"	208	25	\$1,441
MCRLF2472R	24"	72"	29"	219	30	\$1,530

For H30 handles...add \$56/ea.

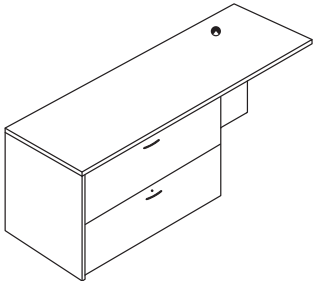

Return, 31" Lateral File (H3B handles, lock, full modesty), Left

Model#	Depth	Width	Height	Weight	Cube	Price
MCRLF2054L	20"	54"	29"	192	19	\$1,331
MCRLF2060L	20"	60"	29"	198	21	\$1,352
MCRLF2072L	20"	72"	29"	212	25	\$1,462
MCRLF2454L	24"	54"	29"	201	23	\$1,407
MCRLF2460L	24"	60"	29"	208	25	\$1,441
MCRLF2472L	24"	72"	29"	219	30	\$1,530

For H30 handles...add \$56/ea.

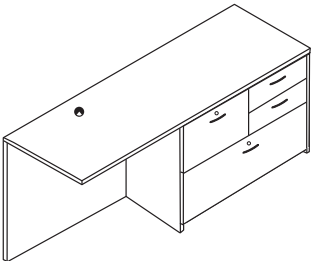

Return, 31" Personal Lateral File (H3B handles, locks, full modesty), Right

Model#	Depth	Width	Height	Weight	Cube	Price
MCRPLF2054R	20"	54"	29"	195	19	\$1,427
MCRPLF2060R	20"	60"	29"	201	23	\$1,474
MCRPLF2072R	20"	72"	29"	216	25	\$1,578
MCRPLF2454R	24"	54"	29"	205	23	\$1,441
MCRPLF2460R	24"	60"	29"	213	28	\$1,503
MCRPLF2472R	24"	72"	29"	223	30	\$1,626

Box drawers do not lock.

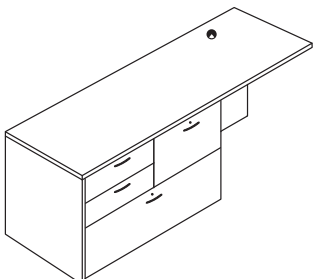

Return, 31" Personal Lateral File (H3B handles, locks, full modesty), Left

Model#	Depth	Width	Height	Weight	Cube	Price
MCRPLF2054L	20"	54"	29"	195	19	\$1,427
MCRPLF2060L	20"	60"	29"	201	23	\$1,474
MCRPLF2072L	20"	72"	29"	216	25	\$1,578
MCRPLF2454L	24"	54"	29"	205	23	\$1,441
MCRPLF2460L	24"	60"	29"	213	28	\$1,503
MCRPLF2472L	24"	72"	29"	223	30	\$1,626

Box drawers do not lock.

For handle selection...no charge. Specify from H5-H14, see pp. 102. See available accessories and upgrades, pp. 103-106



Maverick Complete

Credenzas

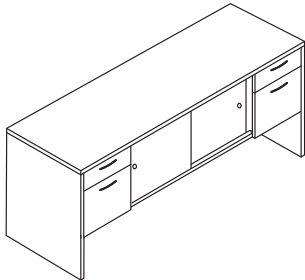

**Credenza, Double Pedestal, Box/File Left and Right, Center Storage
(Sliding doors, H3B handles, lock)**

	Model#	Depth	Width	Height	Weight	Cube	Price
Qs	MCC2060 2	20"	60"	29"	230	21	\$1,159
Qs	MCC2066 2	20"	66"	29"	240	23	\$1,344
Qs	MCC2072 2	20"	72"	29"	250	25	\$1,357
Qs	MCC2472 2	24"	72"	29"	270	30	\$1,433

Storage includes one adjustable ¾" thick shelf. May be upgraded to hinged doors, add UPHD2...\$187.
NOTE: Ped lock is inside doors.

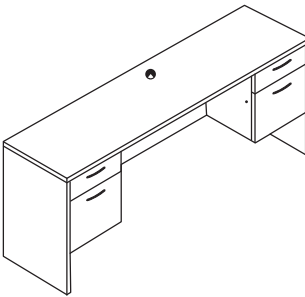

**Credenza, Double Pedestal, Box/File Left and Right
(Knee space, Full modesty, H3B handles, lock)**

	Model#	Depth	Width	Height	Weight	Cube	Price
Qs	MCC2060 3	20"	60"	29"	196	21	\$1,165
Qs	MCC2066 3	20"	66"	29"	205	23	\$1,359
Qs	MCC2072 3	20"	72"	29"	210	25	\$1,380
Qs	MCC2472 3	24"	72"	29"	230	30	\$1,412

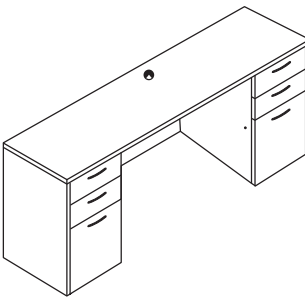

**Credenza, Double Pedestal, Box/Box/File Left and Right
(Knee space, full modesty, H3B handles, lock)**

	Model#	Depth	Width	Height	Weight	Cube	Price
Qs	MCCC2060 3	20"	60"	29"	245	21	\$1,630
Qs	MCCC2066 3	20"	66"	29"	255	23	\$1,823
Qs	MCCC2072 3	20"	72"	29"	265	25	\$1,843
Qs	MCCC2472 3	24"	72"	29"	290	30	\$1,876

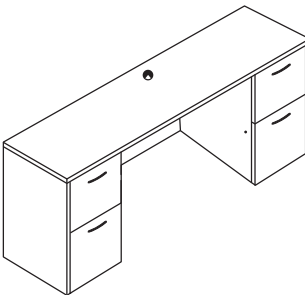

**Credenza, Double Pedestal, File/File Left and Right
(Knee space, full modesty, H3B handles, lock)**

	Model#	Depth	Width	Height	Weight	Cube	Price
Qs	MCCD2060 3	20"	60"	29"	245	21	\$1,548
Qs	MCCD2066 3	20"	66"	29"	255	23	\$1,742
Qs	MCCD2072 3	20"	72"	29"	265	25	\$1,762
Qs	MCCD2472 3	24"	72"	29"	290	30	\$1,794

Maverick Complete



Credenzas

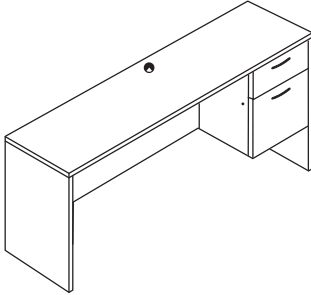

Credenza, Single Box/File Pedestal (Full modesty, H3B handles, lock), Right

Model#	Depth	Width	Height	Weight	Cube	Price
MCC2060 4R	20"	60"	29"	150	21	\$948
MCC2066 4R	20"	66"	29"	157	23	\$1,042
MCC2072 4R	20"	72"	29"	164	25	\$1,057
MCC2472 4R	24"	72"	29"	168	30	\$1,085

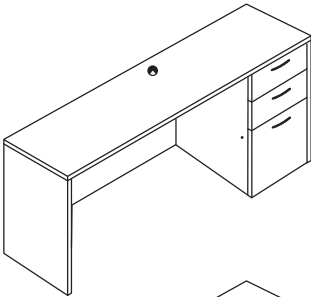

Credenza, Single Box/Box/File Pedestal (Knee space, full modesty, H3B handles, lock), Right

Model#	Depth	Width	Height	Weight	Cube	Price
MCCC2060 4R	20"	60"	29"	185	21	\$1,304
MCCC2066 4R	20"	66"	29"	190	23	\$1,412
MCCC2072 4R	20"	72"	29"	200	25	\$1,426
MCCC2472 4R	24"	72"	29"	220	30	\$1,453

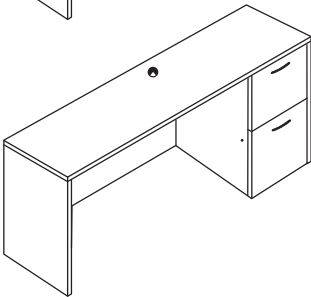

Credenza, Single File/File Pedestal (Knee space, full modesty, H3B handles, lock), Right

Model#	Depth	Width	Height	Weight	Cube	Price
MCCD2060 4R	20"	60"	29"	183	21	\$1,244
MCCD2066 4R	20"	66"	29"	190	23	\$1,351
MCCD2072 4R	20"	72"	29"	200	25	\$1,366
MCCD2472 4R	24"	72"	29"	220	30	\$1,394

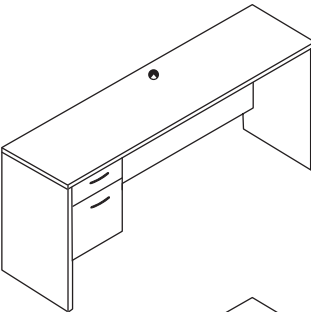

Credenza, Single Box/File Pedestal (Full modesty, H3B handles, lock), Left

Model#	Depth	Width	Height	Weight	Cube	Price
MCC2060 4L	20"	60"	29"	150	21	\$948
MCC2066 4L	20"	66"	29"	157	23	\$1,042
MCC2072 4L	20"	72"	29"	164	25	\$1,057
MCC2472 4L	24"	72"	29"	168	30	\$1,085

For full modesty panel upgrade, add MM FMP...\$55.

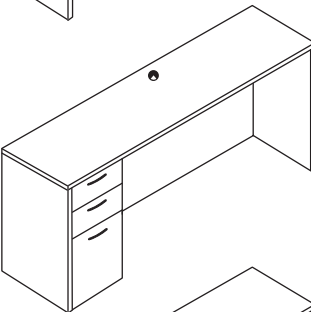

Credenza, Single Box/Box/File Pedestal (Knee space, full modesty, H3B handles, lock), Left

Model#	Depth	Width	Height	Weight	Cube	Price
MCCC2060 4L	20"	60"	29"	185	21	\$1,304
MCCC2066 4L	20"	66"	29"	190	23	\$1,412
MCCC2072 4L	20"	72"	29"	200	25	\$1,426
MCCC2472 4L	24"	72"	29"	220	30	\$1,453

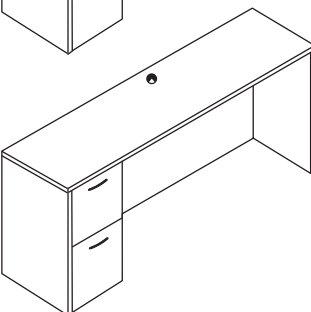

Credenza, Single File/File Pedestal (Knee space, full modesty, H3B handles, lock), Left

Model#	Depth	Width	Height	Weight	Cube	Price
MCCD2060 4L	20"	60"	29"	183	21	\$1,244
MCCD2066 4L	20"	66"	29"	190	23	\$1,351
MCCD2072 4L	20"	72"	29"	200	25	\$1,366
MCCD2472 4L	24"	72"	29"	220	30	\$1,394



Maverick Complete

Credenzas

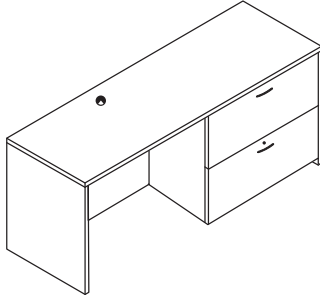

Credenza, 36" Lateral File Pedestal (H3B handles, lock, full modesty), Right

Model#	Depth	Width	Height	Weight	Cube	Price
MCC2066 5R	20"	66"	29"	223	23	\$1,462
MCC2072 5R	20"	72"	29"	230	25	\$1,474
MCC2472 5R	24"	72"	29"	270	30	\$1,543

For H30 handles...add \$56/ea.

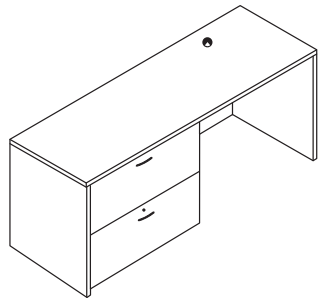

Credenza, 36" Lateral File Pedestal (H3B handles, lock, full modesty), Left

Model#	Depth	Width	Height	Weight	Cube	Price
MCC2066 5L	20"	66"	29"	223	23	\$1,462
MCC2072 5L	20"	72"	29"	230	25	\$1,474
MCC2472 5L	24"	72"	29"	270	30	\$1,543

For H30 handles...add \$56/ea.

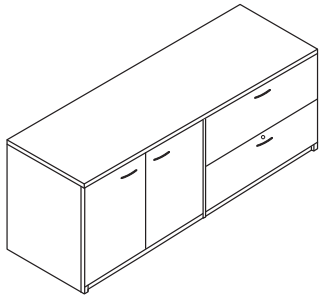

Credenza, Hinged Door Cabinet Left and Lateral File (H3B handles, lock), Right

Model#	Depth	Width	Height	Weight	Cube	Price
MCC2072 9FP	20"	72"	29"	270	30	\$1,768
MCC2472 9FP	24"	72"	29"	290	30	\$1,815

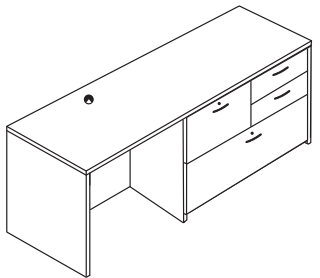

Credenza, 31" Personal Lateral File Pedestal (H3B handles, locks, full modesty), Right

Model#	Depth	Width	Height	Weight	Cube	Price
MCC2066 6R	20"	66"	29"	230	26	\$1,653
MCC2072 6R	20"	72"	29"	236	28	\$1,673
MCC2472 6R	24"	72"	29"	260	30	\$1,741

Box drawers do not lock.

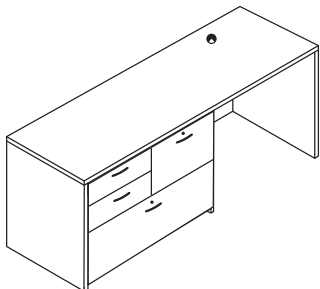

Credenza, 31" Personal Lateral File Pedestal (H3B handles, locks, full modesty), Left

Model#	Depth	Width	Height	Weight	Cube	Price
MCC2066 6L	20"	66"	29"	230	26	\$1,653
MCC2072 6L	20"	72"	29"	236	28	\$1,673
MCC2472 6L	24"	72"	29"	260	30	\$1,741

Box drawers do not lock.

For handle selection...no charge. Specify from H5-H14, see pp. 102. See available accessories and upgrades, pp. 103-106.

Maverick Complete



Credenzas

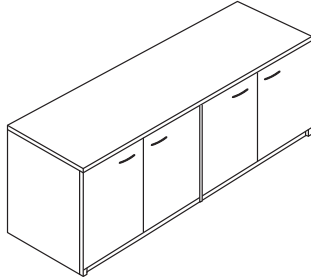

Credenza, Full Storage (H3B handles, hinged doors, two adjustable shelves, locking)

Model#	Depth	Width	Height	Weight	Cube	Price
MCC2060 1FP	20"	60"	29"	220	21	\$1,579
MCC2066 1FP	20"	66"	29"	240	23	\$1,702
MCC2072 1FP	20"	72"	29"	260	25	\$1,723
MCC2472 1FP	24"	72"	29"	295	30	\$1,861

Shelves are 3/4" thick. For H30 handles...add \$56/ea.

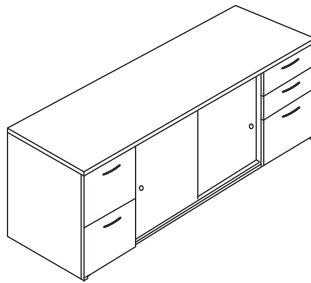

Credenza, Full Pedestal F/F Left and B/B/F Right, Center Storage (Sliding doors)

Model#	Depth	Width	Height	Weight	Cube	Price
MCC2060 2FP	20"	60"	29"	270	21	\$1,687
MCC2066 2FP	20"	66"	29"	300	23	\$1,871
MCC2072 2FP	20"	72"	29"	330	25	\$1,887
MCC2472 2FP	24"	72"	29"	360	30	\$1,933

Storage includes one adjustable 3/4" thick shelf. May be upgraded to hinged doors, add MM UPHD2...\$187.

NOTE: Ped lock is inside doors...add MMPL...\$71/ea

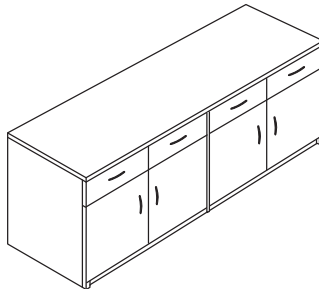

Credenza, Buffet (4 box drawers, full hinged doors, H3B handles, locking doors only)

Model#	Depth	Width	Height	Weight	Cube	Price
MCHDBC2036	20"	36"	36"	220	15	\$1,118
MCHDBC2436	24"	36"	36"	240	18	\$1,221
MCHDBC2072	20"	72"	36"	260	30	\$2,310
MCHDBC2472	24"	72"	36"	290	36	\$2,405

Storage includes two adjustable 3/4" thick shelves.

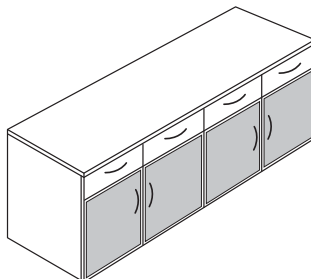

Credenza, Buffet (4 box drawers, full hinged glass doors, H3B handles)

Model#	Depth	Width	Height	Weight	Cube	Price
MMHDBC2072G	20"	72"	36"	240	18	\$2,955
MMHDBC2472G	24"	72"	36"	290	36	\$3,049

Storage includes two adjustable 3/4" thick shelves. Locks N/A for glass doors.

Optional face locks available for box drawers, add MM FL...\$71 each.



Maverick Complete

CompuCorner Credenzas

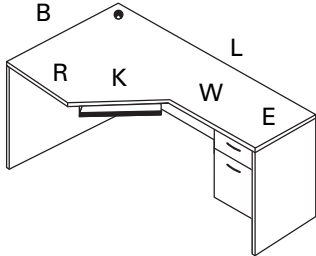

Computer Corner, Box/File Pedestal (H3B handles, locks, Full modesty), Right

Model#	(L)	(B)	(E)	(K)	(R)	(W)	Weight	Cube	Price
MCCD66 4R	66"	36"	24"	21"	24"	24"	229	42	\$1,124
MCCD72 3R	72"	36"	20"	24"	20"	33"	249	45	\$1,187
MCCD72 4R	72"	36"	24"	21"	24"	30"	249	45	\$1,076
MCCD72 7R	72"	36"	24"	23"	20"	32"	285	45	\$1,171
MCCD72 8R	72"	42"	24"	24"	24"	33"	285	53	\$1,412

Keyboard tray and worksurface black grommet standard. Upgrade grommet cover to silver, N/C.

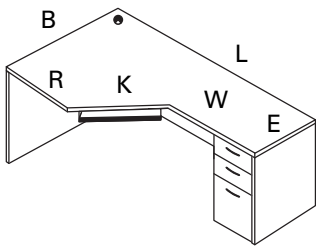

Computer Corner, Box/Box/File Pedestal (H3B handles, locks, Full modesty), Right

Model#	(L)	(B)	(E)	(K)	(R)	(W)	Weight	Cube	Price
MCCD66C 4R	66"	36"	24"	21"	24"	24"	245	42	\$1,494
MCCD72C 3R	72"	36"	20"	24"	20"	33"	265	45	\$1,555
MCCD72C 4R	72"	36"	24"	21"	24"	30"	265	45	\$1,446
MCCD72C 7R	72"	36"	24"	23"	20"	32"	300	45	\$1,542
MCCD72C 8R	72"	42"	24"	24"	24"	33"	300	53	\$1,783

Keyboard tray and worksurface black grommet standard. Upgrade grommet cover to silver, N/C.

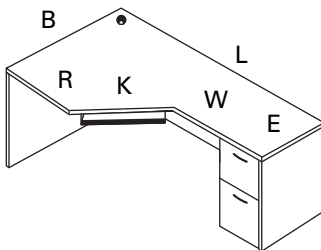

Computer Corner, File/File Pedestal (H3B handles, locks, Full modesty), Right

Model#	(L)	(B)	(E)	(K)	(R)	(W)	Weight	Cube	Price
MCCD66D 4R	66"	36"	24"	21"	24"	24"	245	42	\$1,385
MCCD72D 3R	72"	36"	20"	24"	20"	33"	265	45	\$1,447
MCCD72D 4R	72"	36"	24"	21"	24"	30"	265	45	\$1,385
MCCD72D 7R	72"	36"	24"	23"	20"	32"	300	45	\$1,481
MCCD72D 8R	72"	42"	24"	24"	24"	33"	300	53	\$1,722

Keyboard tray and worksurface black grommet standard. Upgrade grommet cover to silver, N/C.

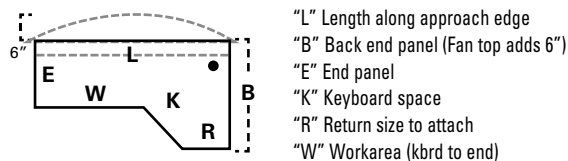

Maverick Complete



CompuCorner Credenzas

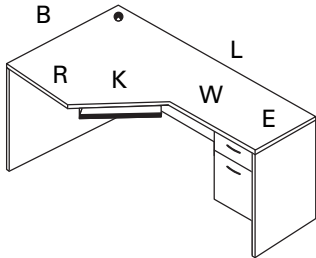

Computer Corner, Box/File Pedestal (H3B handles, locks, Full modesty), Right

Model#	(L)	(B)	(E)	(K)	(R)	(W)	Weight	Cube	Price
MCCD66 4L	66"	36"	24"	21"	24"	24"	229	42	\$1,124
MCCD72 3L	72"	36"	20"	24"	20"	33"	249	45	\$1,187
MCCD72 4L	72"	36"	24"	21"	24"	30"	249	45	\$1,076
MCCD72 7L	72"	36"	24"	23"	20"	32"	285	45	\$1,171
MCCD72 8L	72"	42"	24"	24"	24"	33"	285	53	\$1,412

Keyboard tray and worksurface black grommet standard. Upgrade grommet cover to silver, N/C.

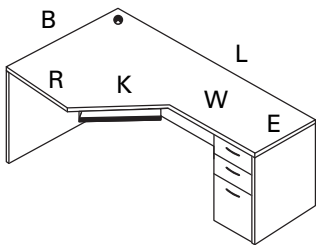

Computer Corner, Box/Box/File Pedestal (H3B handles, locks, Full modesty), Right

Model#	(L)	(B)	(E)	(K)	(R)	(W)	Weight	Cube	Price
MCCD66C 4L	66"	36"	24"	21"	24"	24"	245	42	\$1,494
MCCD72C 3L	72"	36"	20"	24"	20"	33"	265	45	\$1,555
MCCD72C 4L	72"	36"	24"	21"	24"	30"	265	45	\$1,446
MCCD72C 7L	72"	36"	24"	23"	20"	32"	300	45	\$1,542
MCCD72C 8L	72"	42"	24"	24"	24"	33"	300	53	\$1,783

Keyboard tray and worksurface black grommet standard. Upgrade grommet cover to silver, N/C.

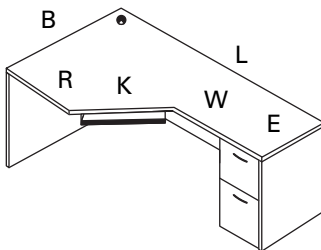

Computer Corner, File/File Pedestal (H3B handles, locks, Full modesty), Right

Model#	(L)	(B)	(E)	(K)	(R)	(W)	Weight	Cube	Price
MCCD66D 4L	66"	36"	24"	21"	24"	24"	245	42	\$1,385
MCCD72D 3L	72"	36"	20"	24"	20"	33"	265	45	\$1,447
MCCD72D 4L	72"	36"	24"	21"	24"	30"	265	45	\$1,385
MCCD72D 7L	72"	36"	24"	23"	20"	32"	300	45	\$1,481
MCCD72D 8L	72"	42"	24"	24"	24"	33"	300	53	\$1,722

Keyboard tray and worksurface black grommet standard. Upgrade grommet cover to silver, N/C.

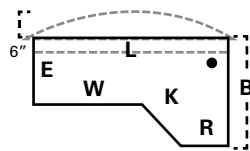

- "L" Length along approach edge
- "B" Back end panel (Fan top adds 6")
- "E" End panel
- "K" Keyboard space
- "R" Return size to attach
- "W" Workarea (kbrd to end)



Maverick Complete

CompuCorner Credenzas

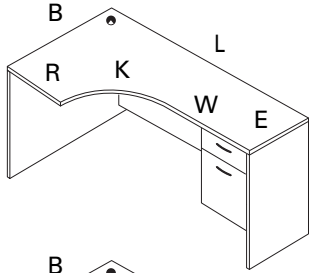

Computer Corner, Curved, 3/4 Box/File Pedestal (H3B handles, locks, Full modesty), Right

Model#	(L)	(B)	(E)	(K)	(R)	(W)	Weight	Cube	Price
MCCDQ72 4R	72"	36"	24"	21"	24"	30"	239	45	\$1,076

No keyboard tray. Worksurface black grommet standard. Upgrade grommet cover to silver, N/C.

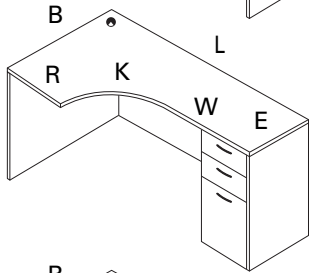

Computer Corner, Curved, Box/Box/File Pedestal (H3B handles, locks, Full modesty), Right

Model#	(L)	(B)	(E)	(K)	(R)	(W)	Weight	Cube	Price
MCCDQ72C 4R	72"	36"	24"	21"	24"	30"	254	45	\$1,446

No keyboard tray. Worksurface black grommet standard. Upgrade grommet cover to silver, N/C.

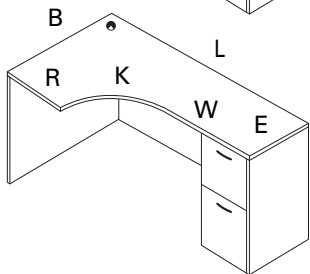

Computer Corner, Curved, File/File Pedestal (H3B handles, locks, Full modesty), Right

Model#	(L)	(B)	(E)	(K)	(R)	(W)	Weight	Cube	Price
MCCDQ72D 4R	72"	36"	24"	21"	24"	30"	254	45	\$1,386

No keyboard tray. Worksurface black grommet standard. Upgrade grommet cover to silver, N/C.

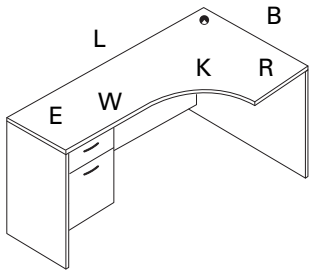

Computer Corner, Curved, 3/4 Box/File Pedestal (H3B handles, locks, Full modesty), Left

Model#	(L)	(B)	(E)	(K)	(R)	(W)	Weight	Cube	Price
MCCDQ72 4L	72"	36"	24"	21"	24"	30"	239	45	\$1,076

No keyboard tray. Worksurface black grommet standard. Upgrade grommet cover to silver, N/C.

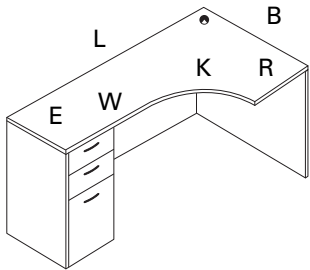

Computer Corner, Curved, Box/Box/File Pedestal (H3B handles, locks, Full modesty), Left

Model#	(L)	(B)	(E)	(K)	(R)	(W)	Weight	Cube	Price
MCCDQ72C 4L	72"	36"	24"	21"	24"	30"	254	45	\$1,446

No keyboard tray. Worksurface black grommet standard. Upgrade grommet cover to silver, N/C.

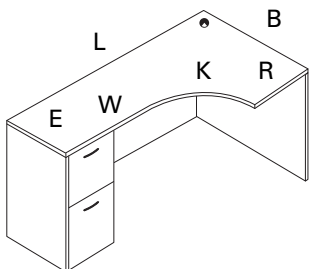

Computer Corner, Curved, File/File Pedestal (H3B handles, locks, Full modesty), Left

Model#	(L)	(B)	(E)	(K)	(R)	(W)	Weight	Cube	Price
MCCDQ72D 4L	72"	36"	24"	21"	24"	30"	254	45	\$1,386

No keyboard tray. Worksurface black grommet standard. Upgrade grommet cover to silver, N/C.

Maverick Complete



CompuCorner Credenzas

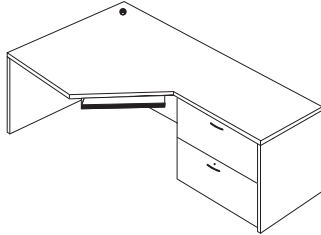

Computer Corner, 31" Lateral File (H3B handles, lock, full modesty), Right

Model#	(L)	(B)	(E)	(K)	(R)	(W)	Weight	Cube	Price
MMCD72LF 3R	72"	36"	20"	24"	20"	33"	249	45	\$1,447
MMCD72LF 4R	72"	36"	24"	21"	24"	30"	265	45	\$1,527

Keyboard tray and worksurface black grommet standard. Upgrade to H3S handles...N/C.
Upgrade grommet cover to silver, N/C.

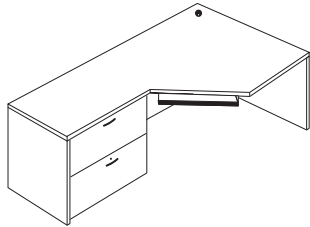

Computer Corner, 31" Lateral File (H3B handles, lock, full modesty), Left

Model#	(L)	(B)	(E)	(K)	(R)	(W)	Weight	Cube	Price
MMCD72LF 3L	72"	36"	20"	24"	20"	33"	249	45	\$1,447
MMCD72LF 4L	72"	36"	24"	21"	24"	30"	265	45	\$1,527

Keyboard tray and worksurface black grommet standard. Upgrade to H3S handles...N/C.
Upgrade grommet cover to silver, N/C.

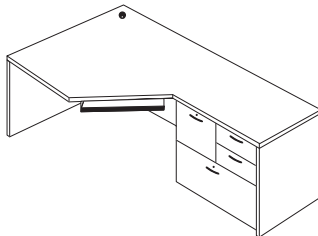

Computer Corner, 31" Personal Lateral File, Right (H3B handles, locks, full modesty)

Model#	(L)	(B)	(E)	(K)	(R)	(W)	Weight	Cube	Price
MMCD72PLF 3R	72"	36"	20"	24"	20"	33"	249	45	\$1,605
MMCD72PLF 4R	72"	36"	24"	21"	24"	30"	265	45	\$1,647

Keyboard tray and worksurface black grommet standard. Box drawers do not lock. Upgrade to H3S handles...N/C.
Upgrade grommet cover to silver, N/C.

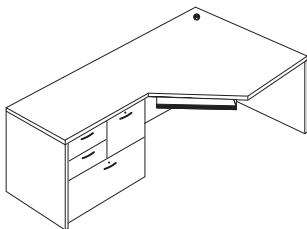

Computer Corner, 31" Personal Lateral File, Left (H3B handles, locks, full modesty)

Model#	(L)	(B)	(E)	(K)	(R)	(W)	Weight	Cube	Price
MMCD72PLF 3L	72"	36"	20"	24"	20"	33"	249	45	\$1,605
MMCD72PLF 4L	72"	36"	24"	21"	24"	30"	265	45	\$1,647

Keyboard tray and worksurface black grommet standard. Box drawers do not lock. Upgrade to H3S handles...N/C.
Upgrade grommet cover to silver, N/C.

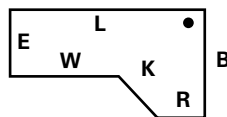

"L" Length along approach edge

"B" Back end panel

"E" End panel

"K" Keyboard space

"R" Return size to attach

"W" Workarea (kbd to end)



Maverick Complete

CompuCorner Credenzas

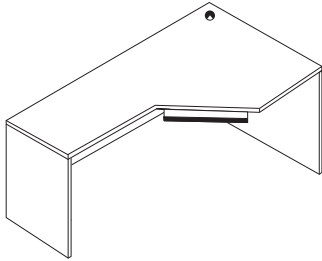

Computer Corner Shell (Full modesty), For Right Return

Model#	(L)	(B)	(E)	(K)	(R)	(W)	Weight	Cube	Price
MCCDN60 2R	60"	30"	20"	21"	20"	21"	184	32	\$774
MCCDN72 3R	72"	36"	20"	24"	20"	33"	213	45	\$898
MCCDN72 4R	72"	36"	24"	21"	24"	30"	213	45	\$926

Keyboard tray and worksurface black grommet standard. Upgrade grommet cover to silver, N/C.

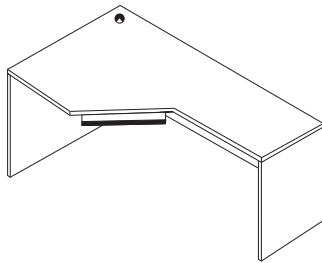

Computer Corner Shell (Full modesty), For Left Return

Model#	(L)	(B)	(E)	(K)	(R)	(W)	Weight	Cube	Price
MCCDN60 2L	60"	30"	20"	21"	20"	21"	184	32	\$774
MCCDN72 3L	72"	36"	20"	24"	20"	33"	213	45	\$898
MCCDN72 4L	72"	36"	24"	21"	24"	30"	213	45	\$926

Keyboard tray and worksurface black grommet standard. Upgrade grommet cover to silver, N/C.

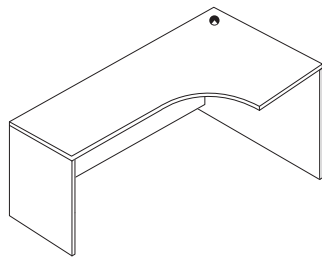

Computer Corner Shell, Curved (Full modesty), For Right Return

Model#	(L)	(B)	(E)	(K)	(R)	(W)	Weight	Cube	Price
MCCDNQ72 4R	72"	36"	24"	21"	24"	30"	213	45	\$926

Worksurface black grommet standard. No keyboard tray. Upgrade grommet cover to silver, N/C.

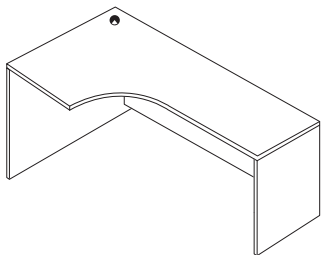

Computer Corner Shell, Curved, For Left Return (Full modesty)

Model#	(L)	(B)	(E)	(K)	(R)	(W)	Weight	Cube	Price
MCCDNQ72 4L	72"	36"	24"	21"	24"	30"	213	45	\$926

Worksurface black grommet standard. No keyboard tray. Upgrade grommet cover to silver, N/C.

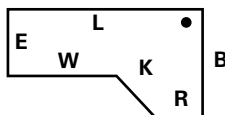

- "L" Length along approach edge
- "B" Back end panel
- "E" End panel
- "K" Keyboard space
- "R" Return size to attach
- "W" Workarea (kbrd to end)

See available accessories and upgrades, pp. 102-106.

Maverick Complete



Hutches

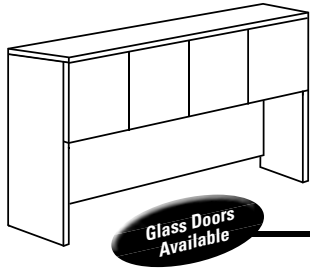

Hutch, with Doors (18" below Fascia)

Model#	Depth	Width	Height	Weight	Cube	Price
MCH48 WD	14"	48"	36"	130	14	\$1,048
MCH60 WD	14"	60"	36"	155	18	\$1,124
MCH66 WD	14"	66"	36"	167	20	\$1,212
MCH72 WD	14"	72"	36"	179	21	\$1,240
MCH72 WG	14"	72"	36"	179	21	\$1,716

Optional face locks available (two locks required), add MM FL...\$71 each. Glass doors do NOT lock.

May be upgraded to 42" height, add MM UHH...\$151. Add tasklights and tackboards, see p. 94.

Ends are 3/4" thick; doors overlay legs but are inset to the 1"-thick top.

Add 25% for HPL White Gloss doors with Brushed metal edge banding.

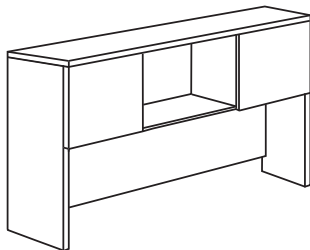

Hutch, Two Doors, Center Opening (18" below Fascia)

Model#	Depth	Width	Height	Weight	Cube	Price
MCH60 W2D	14"	60"	36"	140	18	\$1,026
MCH66 W2D	14"	66"	36"	152	20	\$1,076
MCH72 W2D	14"	72"	36"	164	21	\$1,124

Optional face locks available (two locks required), add MM FL...\$71 each. Doors are same width as open space.

May be upgraded to 42" height, add MM UHH...\$151. Add tasklights and tackboards, see p. 94. Ends are 3/4" thick; doors overlay legs but are inset to the 1"-thick top. Add 25% for HPL White Gloss doors with Brushed metal edge banding.

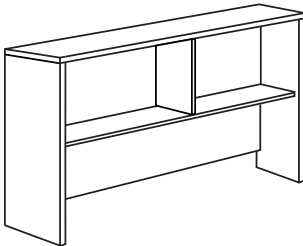

Hutch, No Doors (18" below Fascia)

Model#	Depth	Width	Height	Weight	Cube	Price
MCH48 ND	14"	48"	36"	115	14	\$788
MCH60 ND	14"	60"	36"	135	18	\$814
MCH66 ND	14"	66"	36"	148	20	\$877
MCH72 ND	14"	72"	36"	160	21	\$959

May be upgraded to 42" height, add MM UHH...\$151. Add tasklights, fascia and tackboards, see p. 94. Ends are 3/4" thick; doors overlay legs but are inset to the 1"-thick top.



Bookcase Hutch (One adjustable shelf, One fixed shelf, 1"-thick shelves)

Model#	# Shelves	Depth	Width	Height	Weight	Cube	Price
MMBCH	2	14"	36"	36"	72	11	\$411

May be upgraded to 42" height, add MM UHH...\$141. Width coordinates with lateral files and utility cabinets.

Ends are 3/4" thick; legs are inset to the 1"-thick top, see p. 94.

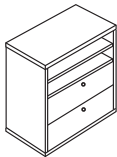

Paper Manager Mail Sorter (One fixed shelf, two drawers, set-on-surface, flat PVC edges)

Model#	Depth	Width	Height	Weight	Cube	Price
MM MS111717 2DR	11"	17"	17"	10	1.4	\$435

Freestanding for desktop placement.

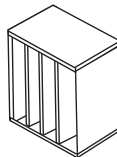

Vertical File Holder (Three fixed shelves, set-on-surface, flat PVC edges)

Model#	Depth	Width	Height	Weight	Cube	Price
MM VFH121414	12"	14"	14"	10	1.4	\$256

Freestanding for desktop placement.

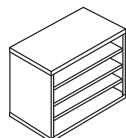

Paper Manager Mail Sorter (Three adjustable shelves, set-on-surface, flat PVC edges)

Model#	Depth	Width	Height	Weight	Cube	Price
MM MS121414	12"	14"	14"	10	1.4	\$279

Freestanding for desktop placement.



Maverick Complete

Cabinets

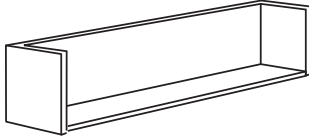

Overhead Wall-Mounted Cabinet, No Doors (Limited weight capacity)

Model#	Depth	Width	Height	Weight	Cube	Price
MMCFOHA48	14 3/4"	48"	14"	65	6	\$561
MMCFOHA60	14 3/4"	60"	14"	75	8	\$644

125lb. weight capacity. Requires professional installation and must be mounted to wall stud.

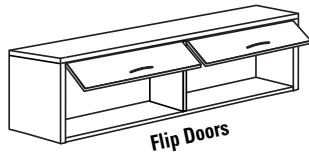

Overhead Wall-Mounted Cabinet With Flip or Hinged Doors (Limited weight capacity, H3B handles)

Model#	Depth	Width	Height	# of Doors	Weight	Cube	Price
MCCFOHB48	14 3/4"	48"	16"	2	110	7	\$1,117
MCCFOHB60	14 3/4"	60"	16"	2	120	9	\$1,210
MCCFOHD36	14 3/4"	36"	16"	2	110	7	\$864
MCCFOHD48	14 3/4"	48"	16"	4	120	9	\$1,301
MCCFOHD60	14 3/4"	60"	16"	4	120	9	\$1,375

Limited weight capacity. Requires professional installation and must be mounted to wall stud.
Weight 125lbs. @ capacity.

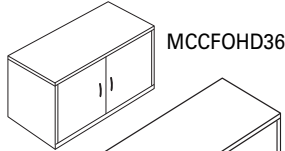

MCCFOHD36

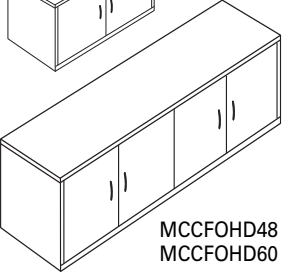

MCCFOHD48
MCCFOHD60

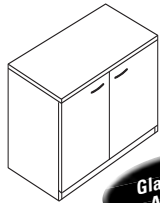

Glass Doors Available

Hinged Door Utility Cabinet (H3B handle, one 3/4"-thick adjustable shelf, locking)

Model#	Depth	Width	Height	Weight	Cube	Price
*MCHDC2036	20"	36"	29"	115	13	\$785
MCHDC2042	20"	42"	29"	165	15	\$828
*MCHDC2436	24"	36"	29"	175	15	\$897
MCHDC2442	24"	42"	29"	180	18	\$965
MCHDC2436G	24"	36"	29"	175	18	\$1,189

Width coordinates with bookcase hutch. Glass doors do NOT lock.

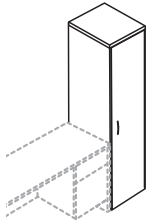

Single Storage Cabinet, Right (H3B handle, three adjustable 3/4"-thick shelves, locking)

Model#	Depth	Width	Height	Weight	Cube	Price
MCSTS1665R	20"	16"	65"	185	12	\$965

Add 25% for HPL White Gloss doors with Brushed metal edge banding.
Add \$56 List for H30 Handle.

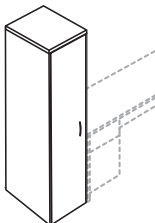

Single Storage Cabinet, Left (H3B handle, three adjustable 3/4"-thick shelves, locking)

Model#	Depth	Width	Height	Weight	Cube	Price
MCSTS1665L	20"	16"	65"	185	12	\$965

Add 25% for HPL White Gloss doors with Brushed metal edge banding.
Add \$56 List for H30 Handle.

Maverick Complete



Cabinets, Bookcases

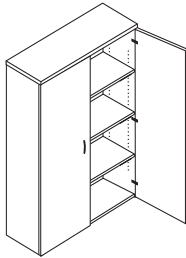

Double Storage Cabinet (H3B handles, 3/4"-thick adjustable shelves, locking)

Model#	# Shelves	Depth	Width	Height	Weight	Cube	Price
MCST3642	2	20"	36"	42"	208	18	\$1,040
MCST3665	3	20"	36"	65"	290	27	\$1,287
MCST3672	4	20"	36"	72"	370	30	\$1,457

Add 25% for HPL White Gloss doors with Brushed metal edge banding.
Add \$56/ea. List for H30 Handle.

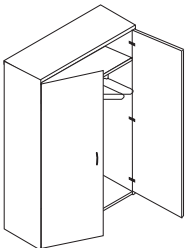

Wardrobe Cabinet (H3B handles, coat rack, one fixed shelf, locking)

Model#	Depth	Width	Height	Weight	Cube	Price
MCWC3665	24"	36"	65"	309	33	\$1,287
MCWC3672	24"	36"	72"	325	36	\$1,457

Add 25% for HPL White Gloss doors with Brushed metal edge banding.
For H30 Handle, add...\$56 each.

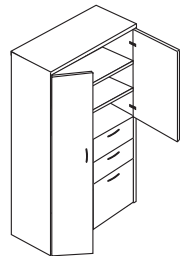

Personal Storage Cabinet (H3B handles on doors and box/box/file pedestal, 2 adjustable shelves, locking pedestal (lock inside door))

Model#	Depth	Width	Height	Weight	Cube	Price
MCWCP2465	24"	24"	65"	309	22	\$2,031
MCWCP2472	24"	24"	72"	325	24	\$2,181

Coat rack in long compartment. Add 25% for HPL White Gloss doors with Brushed metal edge banding.

Bookcases

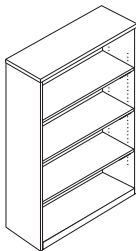

Bookcase (1"-thick adjustable shelves)

Model#	# Shelves	Depth	Width	Height	Weight	Cube	Price
MMBC3630	1	12"	36"	29"	61	18	\$398
MMBC3648	2	12"	36"	48"	86	12	\$535
MMBC3660	3	12"	36"	60"	107	15	\$645
MMBC3665	3	12"	36"	65"	111	17	\$672
MMBC3672	4	12"	36"	72"	128	18	\$698
MMBC3684	5	12"	36"	84"	137	21	\$871

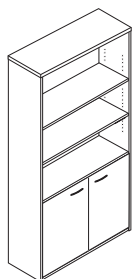

Bookcase with Storage Cabinet (H3B handles, 1"-thick adjustable shelves, locking)

Model#	# Shelves	Depth	Width	Height	Weight	Cube	Price
MCBCD3660	2	14"	36"	60"	135	18	\$1,150
MCBCD3672	3	14"	36"	72"	145	21	\$1,191
MCBCD3684	4	14"	36"	84"	155	25	\$1,362

Add 25% for HPL White Gloss doors with Brushed metal edge banding.



Maverick Complete

Bookcases

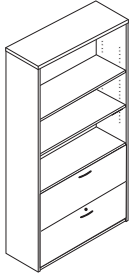

Bookcase with 36" Wide Lateral File (H3B handles, 1"-thick adjustable shelves, lock)

Model#	# Shelves	Depth	Width	Height	Weight	Cube	Price
MMBCLF3660	1	20"	36"	60"	224	25	\$1,482
MMBCLF3672	2	20"	36"	72"	260	30	\$1,557
MMBCLF3684	3	20"	36"	84"	281	35	\$1,714

For H30 Handle, add...\$56 each.

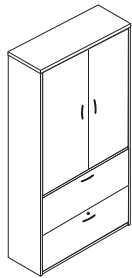

Bookcase with 36" Wide Lateral File & Doors (H3B handles, 1"-thick adjustable shelves, lock)

Model#	# Shelves	Depth	Width	Height	Weight	Cube	Price
MCBCLF3672WD	2	20"	36"	72"	300	30	\$1,952
MCBCLF3684WD	3	20"	36"	84"	331	35	\$2,170

Add 25% for HPL White Gloss doors with Brushed metal edge banding.
For H30 Handle, add...\$56 each.

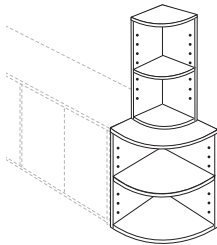

Bookcase, Corner, Right (Order separately, 1"-thick adjustable shelves)

Model#	# Shelves	Depth	Width	Height	Weight	Cube	Price
MMBCC1436R	1	14"	14"	36"	37	4	\$363
MMBCC1442R	2	14"	14"	42"	40	5	\$459
MMBCC2030R	1	20"	20"	29"	58	7	\$473
MMBCC2430R	1	24"	24"	29"	65	8	\$588
MMBCC2065R	3	20"	20"	65"	100	15	\$973
MMBCC2072R	4	20"	20"	72"	115	17	\$1,068

Specify if standalone.

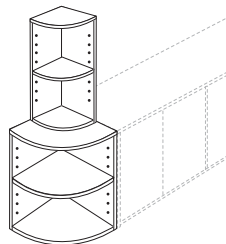

Bookcase, Corner, Left (Order separately, 1"-thick adjustable shelves)

Model#	# Shelves	Depth	Width	Height	Weight	Cube	Price
MMBCC1436L	1	14"	14"	36"	37	4	\$363
MMBCC1442L	2	14"	14"	42"	40	5	\$459
MMBCC2030L	1	20"	20"	29"	58	7	\$473
MMBCC2430L	1	24"	24"	29"	65	8	\$588
MMBCC2065L	3	20"	20"	65"	100	15	\$973
MMBCC2072L	4	20"	20"	72"	115	17	\$1,068

Specify if standalone.

Maverick Complete



Files

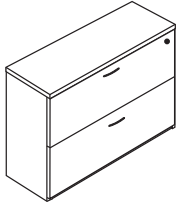

2-drawer Lateral File (H3B handles, Anti-tilt lock)

Model#	Depth	Width	Height	Weight	Cube	Price
 MMLF202	20"	36"	29"	160	13	\$973
 MMLF242	24"	36"	29"	176	15	\$1,015

Upgrade to H30 Handle...\$56 each.

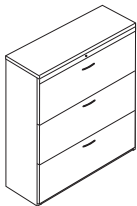

3-drawer Lateral File (H3B handles, anti-tilt lock)

Model#	Depth	Width	Height	Weight	Cube	Price
MMLF203	20"	36"	43"	240	18	\$1,527
MMLF243	24"	36"	43"	264	22	\$1,590

REQUIRES 4-WEEK LEAD TIME. Upgrade to H30 Handle...\$56 each.

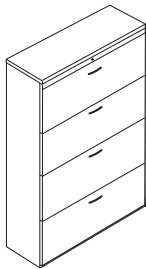

4-drawer Lateral File (H3B handles, anti-tilt lock)

Model#	Depth	Width	Height	Weight	Cube	Price
MMLF204	20"	36"	55"	330	23	\$1,953
MMLF244	24"	36"	55"	335	28	\$2,044

REQUIRES 4-WEEK LEAD TIME. Upgrade to H30 Handle...\$56 each.

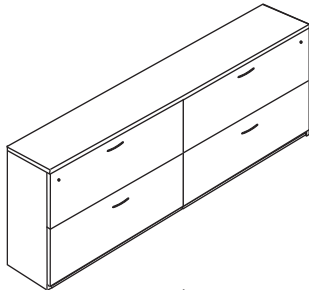

Double Lateral File (H3B handles, Anti-tilt locks)

Model#	Depth	Width	Height	Weight	Cube	Price
MMLF202+2	20"	72"	29"	330	25	\$1,783
MMLF242+2	24"	72"	29"	335	30	\$1,859

Upgrade to H30 Handle...\$56 each.

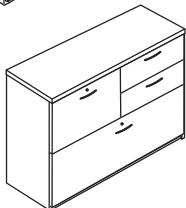

31" Personal Lateral File (H3B handles, locks)

Model#	Depth	Width	Height	Weight	Cube	Price
MMPLF20	20"	31"	29"	189	11	\$973
MMPLF24	24"	31"	29"	205	13	\$1,021

Box drawers do not lock.

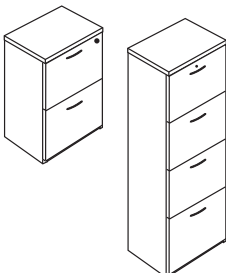

Vertical Files (H3B handles, Anti-tilt lock)

Model#	Depth	Width	Height	Weight	Cube	Price
 MMVF2	24"	16"	29"	160	7	\$686
MMVF2LGL	24"	19"	29"	172	8	\$774
MMVF4*	24"	16"	55"	180	7	\$1,436
MMVF4LGL*	24"	19"	55"	190	8	\$1,556

*REQUIRES 4-WEEK LEAD TIME.



Maverick Complete

Pedestals - Freestanding

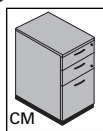

Mobile Pedestal, Box/Box/File (Fully finished, letter size, CX, CX20 with casters)

Model#	Depth	Width	Height	Weight	Cube	Price
MCPED CX	23"	16"	27 5/8"	90	6	\$755
MCPED CX20	19"	16"	27 5/8"	80	6	\$742
MCPED CM	same dimensions as CX, without casters, on a kickbase					\$755
MCPED CM20	same dimensions as CX20, without casters, on a kickbase					\$742

NOTE: Specify placement of lock from user's view. Right is standard. MCPED CX20 and CM20 have 16"-deep drawers. MCPED CX and CM have 20"-deep drawers. CM20 & CM are on a 2"-high kickbase without casters. One convenience tray (MM BPT), one file bar are provided for each drawer.

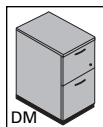
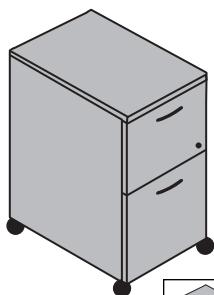

Mobile Pedestal, File/File (Fully finished, letter size, DX, DX20 with casters)

Model#	Depth	Width	Height	Weight	Cube	Price
MCPED DX	23"	16"	27 5/8"	90	6	\$734
MCPED DX20	19"	16"	27 5/8"	80	6	\$720
MCPED DM	same dimensions as DX, without casters, on a kickbase					\$734
MCPED DM20	same dimensions as DX20, without casters, on a kickbase					\$720

NOTE: Specify placement of lock from user's view. Right is standard. MCPED DX20 and DM20 have 16"-deep drawers. MCPED DX and DM have 20"-deep drawers. DM20 & DM are on a 2"-high kickbase without casters. One file bar are provided for each drawer.

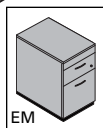
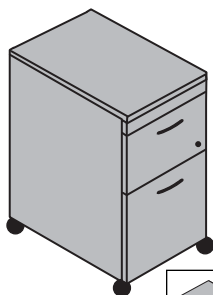

Mobile Pedestal, Pencil/Box/File (Fully finished, letter size, EX, EX20 with casters)

Model#	Depth	Width	Height	Weight	Cube	Price
MCPED EX	23"	16"	24"	90	6	\$734
MCPED EX20	19"	16"	24"	80	6	\$720
MCPED EM	same dimensions as EX, without casters, on a kickbase					\$734
MCPED EM20	same dimensions as EX20, without casters, on a kickbase					\$720

NOTE: Specify placement of lock from user's view. Right is standard. For legal width upgrade, see p. 174. MCPED EX20 and EM20 have 16"-deep drawers. MCPED EX and EM have 20"-deep drawers. EM20 & EM are on a 2"-high kickbase without casters. One convenience tray (MM BPT), one file bar are provided for each drawer.

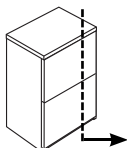

Upgrade from Standard to Legal Width (Two drawers)

Model#	Depth	Width	Height	Weight	Cube	Price
MM UPEDLGL	24"	19"	varies"	128	8	\$90

See available accessories and upgrades, pp. 102-106.

Maverick Complete



Upgrades and Accessories for Hutches

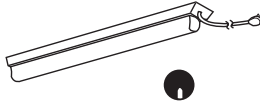

Tasklight (Black, one light only) grommet on hutch back

Model#	Depth	Width	Height	Weight	Cube	Price
MC TSKLTX	7/8"	24 1/2"	1 7/8"	2	.1	\$202/ea.

72" hutch takes 2 lights.

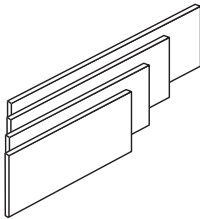

Hutch Tackboards (Uses Guilford of Maine), for Cosmopolitan & Underground fabrics...add 25%*

Model#	Depth	Width	Height	Weight	Cube	Price
MM TKBD30	1"	28"	14 1/4"	9	.5	\$355
MM TKBD42	1"	40"	14 1/4"	12	.6	\$381
MM TKBD54	1"	52"	14 1/4"	15	.7	\$440
MM TKBD60	1"	58"	14 1/4"	17	.8	\$466
MM TKBD66	1"	64"	14 1/4"	19	1	\$498
MM TKBD72	1"	70"	14 1/4"	21	1	\$530
MM TKBD78 (2pc.)	1"	76"	14 1/4"	21	1	\$566

For fabric color samples, see inside back cover. COM tackboards...add \$25/Sq. yd.
Required yardage to be provided by customer. 78" width is made in 2 pieces.

Fabric Chart

STANDARD FABRICS

Tempest 2120...Zebra 015, Silk 045 **Sprite 2671**...Snow 7040, Linen 7010 **Anchorage 2335**...Sunshine 2082, Waterfall 2691, Green Apple 2087, Aubergine 2036, Goose 2049, Onyx 2016, Red Delicious 2014

Metro 3077...Storefront 030, Skyscraper 022 **Cape Cod 3073**...Linen 7031, Surf 7062

Metallation 5118...Chrome 1676, Polished Pewter 1678 **Otto 2670**...Pebble 7012, Platinum 7010

25% UPCHARGE*

* **Cosmopolitan 3097**...Ivory 020, Cornsilk 021, Everglade 010, Shadow 060, Earthen 070

* **Underground 2967**...Champagne 010, Tangerine 070, Azure 050, Ocean 041, Pepper 030, Earth 061

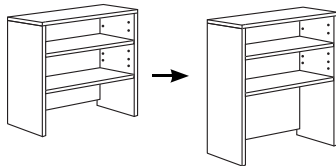

Increase 36"-height Hutch to 42"-height Hutch

MM UHH		\$162
--------	--	-------

Doors or shelves do not change. Available for hutches (H) and Bookcase Hutch (BCH).
Bottom clearance increases by 6".

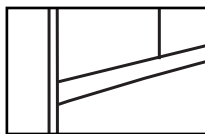

Hutch Fascia/Valance (Decreases clearance under shelf by 2")

Model#	Depth	Width	Height	Weight	Cube	Price
MM VAL	3/4"	varies	2"	varies	varies	\$124

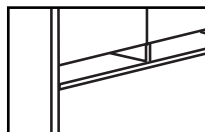

Hutch Mail Slots (Paper Manager) (Decreases clearance under shelf by 5")

Model#	Depth	Width	Height	Weight	Cube	Price
MM HMS	12"	varies	4 3/4"	varies	varies	\$208

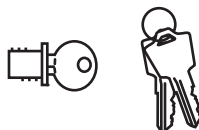

Face Lock (For hutch doors)

Model#	Price
MM FL	\$71

One per set of two doors. Hutch with four doors takes two locks. Glass doors do NOT lock.



Maverick Complete

Upgrades and Accessories

HANDLE OPTIONS FOR UHL2, UHL3, UGL:



Crescent Black
(MM H3B)



Crescent Silver
(MM H3S)



Elliptical Black
(MM H5B)



Elliptical Silver
(MM H5S)



Crescent Textured Nickel
(MM H6)



Flared Nickel
(MM H7)



Bow Handle
(MM H8)



Curved Handle
(MM H9)



Bar Handle
(MM H14)

2 3/4" Plastic

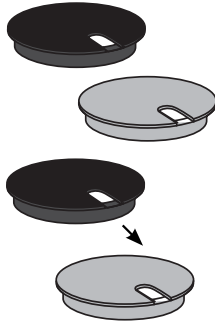

Grommet (Plastic cover, hole in surface, each)

Model#	Depth	Width	Surface Hole Diameter	Price
MM GR234B Black Plastic	3"	3"	2 3/4"	\$45
MM GR234S Silver Plastic	3"	3"	2 3/4"	\$45

Grommet Color, Change Standard Black to Silver (2 3/4" hole in surface, each)

Model#	Color	Depth	Width	Price
MM UGR234 Silver Plastic	Silver Plastic	3"	3"	No Charge

Grommets (WORKSURFACE)

Note: While sitting at unit, grommet locations named from left to right.
For grommet location on tops and/or modesty panel specify left, center or right.
No grommets over pedestals.

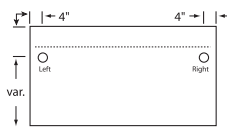

Desks

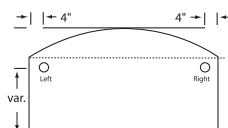

Desks

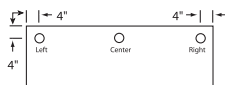

Credenza, Return, Bridges*

* NOTE: CENTER GROMMET IS STANDARD

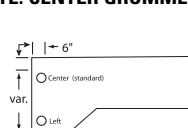

CompuCredenza*

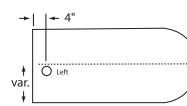

Bullets*

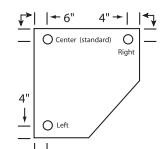

CompuCorner Units*

Maverick Complete

Statement of Line

RECEPTION:

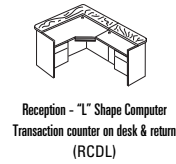
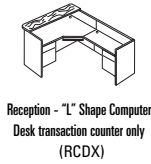
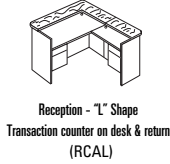
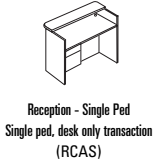

NOTES:

- Before ordering, ensure that the building and room access, including elevators, will accommodate furniture of this size. Use of pin-and-cam construction does facilitate some disassembly.
- Details of front transaction counter vary by series as do pedestals.
- Handles and locks standards vary by series.

How to Order Reception Units

WORKSURFACE UNITS: RECEPTION UNITS

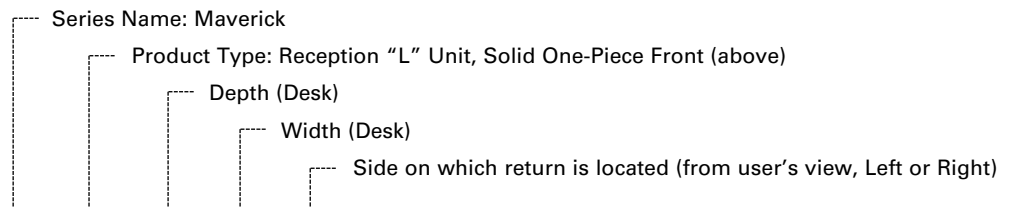

1. Product number: **MC RCAL 36 72 L**
2. Specify worksurface finish. See back cover.
3. Specify worksurface edge trim finish. Matching color edge is standard. See back cover.
4. Specify chassis finish. Matching color edge trim is standard. See back cover.
5. Specify handle (upgrade) options. See page 50 for prices.
6. Specify other accessories and upgrade options. See below and pages 103-106.

HANDLE CHOICES:



Crescent Black
(MM H3B)



Crescent Silver
(MM H3S)



Elliptical Black
(MM H5B)



Elliptical Silver
(MM H5S)



Crescent Textured Nickel
(MM H6)



Flared Nickel
(MM H7)



Bow Handle
(MM H8)



Curved Handle
(MM H9)



Bar Handle
(MM H14)



GROMMET

Black grommet standard. Upgrade to optional silver color, N/C.

R
E
C
E
P
T
I
O
N

IMPORTANT NOTE: Handle is optional. See page 102 for handle options and prices.



Maverick Complete

Risers for Desks and Returns

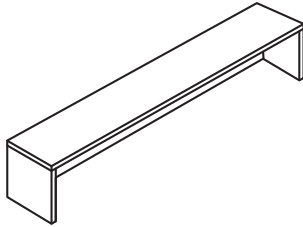

Riser (No approach overhang)

Model#	Depth	Width	Height	Weight	Cube	Price
MMRB36	12"	36"	14"	38	1	\$322
MMRB42	12"	42"	14"	43	2	\$355
MMRB48	12"	48"	14"	47	5	\$363
MMRB60	12"	60"	14"	56	6	\$521
MMRB66	12"	66"	14"	61	7	\$588
MMRB72	12"	72"	14"	65	7	\$657

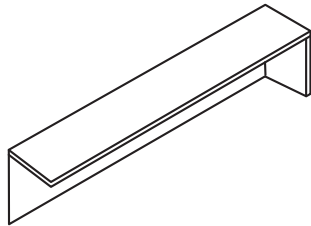

Riser Return, Right (No approach overhang)

Model#	Depth	Width	Height	Weight	Cube	Price
MMRBR36R	12"	36"	14"	32	1	\$322
MMRBR42R	12"	42"	14"	37	2	\$335
MMRBR48R	12"	48"	14"	42	5	\$363
MMRBR54R	12"	54"	14"	47	6	\$440
MMRBR60R	12"	60"	14"	51	6	\$521
MMRBR66R	12"	66"	14"	56	7	\$588
MMRBR72R	12"	72"	14"	60	7	\$657

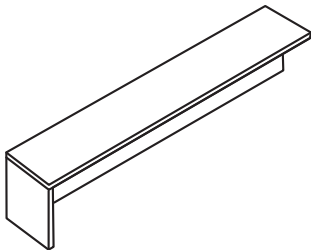

Riser Return, Left (No approach overhang)

Model#	Depth	Width	Height	Weight	Cube	Price
MMRBR36L	12"	36"	14"	32	1	\$322
MMRBR42L	12"	42"	14"	37	2	\$335
MMRBR48L	12"	48"	14"	42	5	\$363
MMRBR54L	12"	54"	14"	47	6	\$440
MMRBR60L	12"	60"	14"	51	6	\$521
MMRBR66L	12"	66"	14"	56	7	\$588
MMRBR72L	12"	72"	14"	60	7	\$657

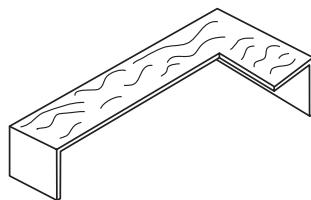

Riser "L" Shape, Right Return (12" deep, one-piece counter top)

Model#	Depth	Width	Height	Weight	Cube	Price
MMRBL3072R	30"	72"	14"	88	18	\$843
MMRBL3672R	36"	72"	14"	92	21	\$961

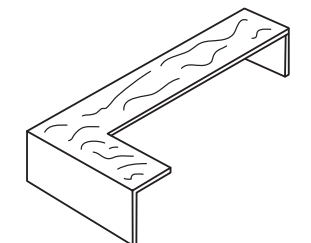

Riser "L" Shape, Left Return (12" deep, one-piece counter top)

Model#	Depth	Width	Height	Weight	Cube	Price
MMRBL3072L	30"	72"	14"	88	18	\$843
MMRBL3672L	36"	72"	14"	92	21	\$961

Notes on standard woodgrain directions:

- The front on the bridge or return unit will display the woodgrain running horizontally for 66" or larger
- On other vertical surfaces, the woodgrain runs vertically
- Worksurface woodgrain on bridge for desk runs left-to-right
- The return countertop grain direction coordinates with the desk surface, running from user's side-to-approach side except on 66" to 72" returns

Maverick Complete



Reception Units - Desk and Return Transaction Counters

NOTE: Before ordering, ensure that the building and room access, including elevators, will accommodate furniture of this size. Use of pin-and-cam construction does facilitate some reassembly. **Upgrade to Full Pedestals, See page 100.**

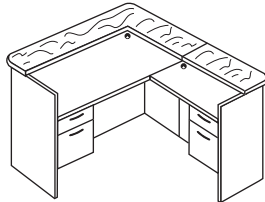

Reception "L" Unit, Solid One-Piece Front, Right Return 24" x 48"* (locks, handles)

Model#	Depth	Width	Height	Weight	Cube	Price
*MCRCAL3060 R	72"	66"	42"	400	92	\$2,873
MCRCAL3072 R	84"	78"	42"	435	104	\$3,073
MCRCAL3672 R	90"	78"	42"	439	115	\$3,189
MCRCAL3684 R	90"	90"	42"	522	127	\$3,456

Counter top is 12" deep. Counter top approach overhang is 6". Worksurface black grommets standard. Fan top on approach side of desk counter may be specified at no upcharge, insert F before C (e.g. MCRFCAL3060R). Transaction counter to desktop clearance is 11 3/4". Upgrade grommet cover to silver, N/C.
*MCRCAL3060 comes with a 20"x36" return.

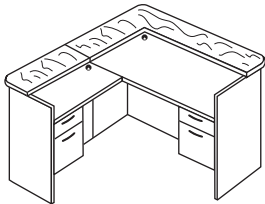

Reception "L" Unit, Solid One-Piece Front, Left Return 24" x 48"* (locks, handles)

Model#	Depth	Width	Height	Weight	Cube	Price
*MCRCAL3060 L	72"	66"	42"	400	92	\$2,873
MCRCAL3072 L	84"	78"	42"	435	104	\$3,073
MCRCAL3672 L	90"	78"	42"	439	115	\$3,189
MCRCAL3684 L	90"	90"	42"	522	127	\$3,456

Counter top is 12" deep. Counter top approach overhang is 6". Worksurface black grommets standard. Fan top on approach side of desk counter may be specified at no upcharge, insert F before C (e.g. MCRFCAL3060L). Transaction counter to desktop clearance is 11 3/4". Upgrade grommet cover to silver, N/C.
*MCRCAL3060 comes with a 20"x36" return.

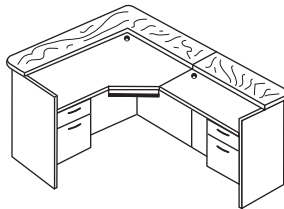

Computer Reception "L" Unit, Solid One-Piece Front, Right Return 24" x 48" (locks, handles)

Model#	Depth	Width	Height	Weight	Cube	Price
MCRCDL3672 R	90"	78"	42"	435	88	\$3,189

Counter top is 12" deep. Counter top approach overhang is 6". Worksurface black grommets and keyboard tray standard. Fan top to approach side of desk counter may be specified at no upcharge, insert F before C (e.g. MCRFCDL3672R). Transaction counter to desktop clearance is 11 3/4". Upgrade grommet cover to silver, N/C.

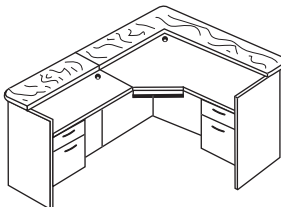

Computer Reception "L" Unit, Solid One-Piece Front, Left Return 24" x 48" (locks, handles)

Model#	Depth	Width	Height	Weight	Cube	Price
MCRCDL3672 L	90"	78"	42"	435	88	\$3,189

Counter top is 12" deep. Counter top approach overhang is 6". Worksurface black grommets and keyboard tray standard. Fan top to approach side of desk counter may be specified at no upcharge, insert F before C (e.g. MCRFCDL3672L). Transaction counter to desktop clearance is 11 3/4". Upgrade grommet cover to silver, N/C.

Notes on standard woodgrain directions:

- The one-piece vertical front on the desk of the unit will display the woodgrain running horizontally (except 60")
- On other vertical surfaces, the woodgrain runs vertically
- Worksurface woodgrain on desk runs left-to-right
- The return worksurface grain direction coordinates with the desk surface, running from user's side to the approach side
- Transaction counter woodgrain runs the same direction as the worksurface woodgrain

See available accessories and upgrades, pp. 102-106.



Maverick Complete

Reception Units - Desk-Only Transaction Counters, "L"s and Reception Desks

NOTE: Before ordering, ensure that the building and room access, including elevators, will accommodate furniture of this size. Use of pin-and-cam construction does facilitate some reassembly. **Upgrade to Full Pedestals, See below.**

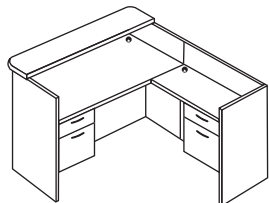

Reception "L" Unit, Solid One-Piece Front, Right Return 24" x 48"*
(Desk counter only, locks, handles)

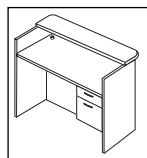

MRCAS3072R

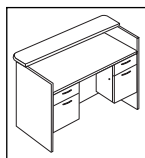

MRCAD3072

Model#	Depth	Width	Height	Weight	Cube	Price
MRCAX3060 R*	72"	60"	42"	390	92	\$2,695
MRCAX3072 R	84"	72"	42"	425	92	\$2,854
MRCAX3672 R	90"	72"	42"	430	92	\$3,148
MRCAS3072 R	30"	72"	42"	250	63	\$1,885
MRCAD3072	30"	72"	42"	320	63	\$2,172

Counter top is 12" deep. Counter top approach overhang is 6". Worksurface black grommets standard. Fan top on approach side of desk counter may be specified at no upcharge, insert F before C (e.g. MCRFCAX3060R). Transaction counter-to-desk top clearance is 11 3/4". *MRCAL3060 comes with a 20"x36" return. Upgrade grommet cover to silver, N/C.

Reception "L" Unit, Solid One-Piece Front, Left Return 24" x 48"*
(Desk counter only, locks, handles)

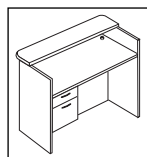
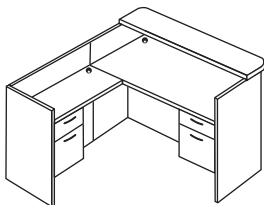

MRCAS3072L

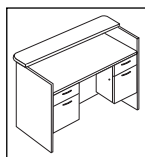

MRCAD3072

Model#	Depth	Width	Height	Weight	Cube	Price
MRCAX3060 L*	72"	60"	42"	390	92	\$2,695
MRCAX3072 L	84"	72"	42"	425	92	\$2,854
MRCAX3672 L	90"	72"	42"	430	92	\$3,148
MRCAS3072 L	30"	72"	42"	250	63	\$1,885
MRCAD3072	30"	72"	42"	320	63	\$2,172

Counter top is 12" deep. Counter top approach overhang is 6". Worksurface black grommets standard. Fan top on approach side of desk counter may be specified at no upcharge, insert F before C (e.g. MCRFCAX3060L). Transaction counter-to-desk top clearance is 11 3/4". *MRCAL3060 comes with a 20"x36" return. Upgrade grommet cover to silver, N/C.

Upgrade to Full Pedestals

Model#	Depth	Width	Height	Weight	Cube	Price
MCUPEDC	19"	15 3/4"	25 3/16"	75	6	\$247
Box/Box/File (ea.)						
MCUPEDD	19"	15 3/4"	25 3/16"	75	6	\$308
File/File (ea.)						

Notes on standard woodgrain directions:

- The one-piece vertical front on the desk of the unit will display the woodgrain running horizontally (except 60")
- On other vertical surfaces, the woodgrain runs vertically
- Worksurface woodgrain on desk runs left-to-right
- The return worksurface grain direction coordinates with the desk surface, running from user's side to the approach side
- Transaction counter woodgrain runs the same direction as the worksurface woodgrain

For handle packages, specify from H3B-H14, see pp. 103. See available accessories and upgrades, pp. 102-106.

Maverick Complete



Reception Units - Desk and Return Transaction Counters

NOTE: Before ordering, ensure that the building and room access, including elevators, will accommodate furniture of this size. Use of pin-and-cam construction does facilitate some reassembly. **Upgrade to Full Pedestals, See below.**
For handles and Pedestal Lock Packages, P. 101.

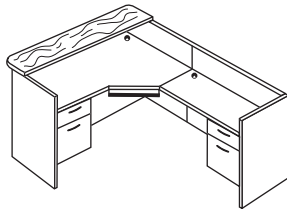

Computer Reception "L" Unit, Solid One-Piece Front, Right Return 24" x 48"

Model#	Depth	Width	Height	Weight	Cube	Price
MCRCDX3672 R	90"	72"	42"	425	88	\$2,854

Counter top is 12" deep. Counter top approach overhang is 6". Worksurface black grommets and keyboard tray standard. Fan top on approach side of desk counter may be specified at no upcharge, insert F before C (e.g. MCRFCDX3672R). Desk counter only. Transaction counter-to-desktop clearance is 11 3/4". Upgrade grommet cover to silver, N/C.

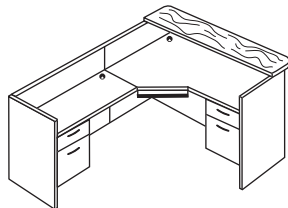

Computer Reception "L" Unit, Solid One-Piece Front, Left Return 24" x 48"

Model#	Depth	Width	Height	Weight	Cube	Price
MCRCDX3672 L	90"	72"	42"	425	88	\$2,854

Counter top is 12" deep. Counter top approach overhang is 6". Worksurface black grommets and keyboard tray standard. Fan top on approach side of desk counter may be specified at no upcharge, insert F before C (e.g. MCRFCDX3672L). Desk counter only. Transaction counter-to-desktop clearance is 11 3/4". Upgrade grommet cover to silver, N/C.

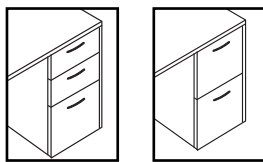

Upgrade to Full Pedestals

Model#	Depth	Width	Height	Weight	Cube	Price
MCUPEDC	19"	15 3/4"	25 3/16"	75	6	\$347

Box/Box/File (ea.)

MCUPEDD	19"	15 3/4"	25 3/16"	75	6	\$308
---------	-----	---------	----------	----	---	-------

File/File (ea.)

Notes on standard woodgrain directions:

- The one-piece vertical front on the desk of the unit will display the woodgrain running horizontally (except 60")
- On other vertical surfaces, the woodgrain runs vertically
- Worksurface woodgrain on desk runs left-to-right
- The return worksurface grain direction coordinates with the desk surface, running from user's side to the approach side
- Transaction counter woodgrain runs the same direction as the worksurface woodgrain



Maverick Complete

HANDLE OPTIONS FOR UHL2, UHL3:



Crescent Black
(MM H3B)



Crescent Silver
(MM H3S)



Elliptical Black
(MM H5B)



Elliptical Silver
(MM H5S)



Crescent Textured Nickel
(MM H6)



Flared Nickel
(MM H7)



Bow Handle
(MM H8)



Curved Handle
(MM H9)



Bar Handle
(MM H14)

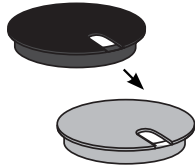

Grommet Color, Change Standard Black to Silver (2 3/4" hole in surface, each)

Model#	Color	Depth	Width	Price
 MM UGR234	Silver Plastic	3"	3"	No Charge

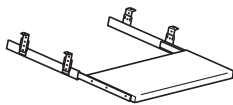

Keyboard Tray, Rollout (Specify laminate color)

Model#	Depth	Width	Height	Weight	Cube	Price
 MM KB	16"	21"	3"	10	.5	\$124

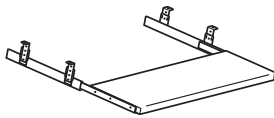

Oversize Keyboard Tray, Rollout (Specify laminate color)

Model#	Depth	Width	Height	Weight	Cube	Price
 MM KBLG	16"	28"	3"	12	.5	\$182



Maverick Complete



Accessories (Specify handle selection...no charge. Upcharge for H30 handles, see below)



Crescent Handle, Metal - Black or Silver Finish



Model#	Hole Center	Width	Color	Price
 MM H3B	5"	5 3/4"	Black	N/C
 MM H3S	5"	5 3/4"	Silver	N/C

Elliptical Handle, Metal - Black or Silver Finish



Model#	Hole Center	Width	Color	Price
 MM H5B	5"	6 3/4"	Black	N/C
 MM H5S	5"	6 3/4"	Silver	N/C

Crescent Textured Nickel Handle, Metal - Silver Finish



Model#	Hole Center	Width	Price
 MM H6	5"	6 1/4"	N/C

Flared Nickel Handle, Metal - Silver Finish



Model#	Hole Center	Width	Price
 MM H7	5"	6 1/4"	N/C

Bow Handle, Silver Finish



Model#	Hole Center	Width	Price
 MM H8	5"	6 1/8"	N/C

Curved Handle, Silver Finish



Model#	Hole Center	Width	Price
 MM H9	5"	6 1/2"	N/C





Bar Handle, Silver Finish

Model#	Hole Center	Width	Price
 MM H14	11"	14"	N/C
MM H30	27"	30"	\$56/ea.

30" wide handles do not fit on pedestal drawers or hutch doors.

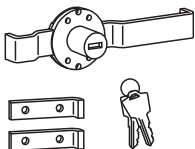
Pedestal Lock



Model#	Price
 MM PL	\$71

Maverick Complete

Accessories and Upgrades

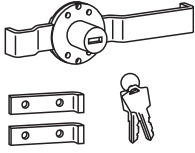

Pedestal Lock (Mounted on side of pedestal - specify user's view L or R for mobile peds)

Model#	Price
Qs MM PL	\$71

For mobile pedestals, specify user's view L or R.

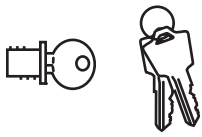

Face Lock (For center drawers, overhead & hinged doors)

Model#	Price
Qs MM FL	\$71

One per set of two doors or drawers. Hutch with two or four doors takes two locks.

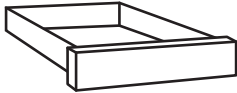

Center Drawer (9-ply birch wood drawer interior, specify front laminate color)

Model#	Depth	Width	Height	Weight	Cube	Price
Qs MM CD	16"	21"	2 1/2"	12	.5	\$135



Box Drawer Convenience Tray (Insets to box drawer)

Model#	Depth	Width	Height	Weight	Cube	Price
Qs MM BPT	5 1/2"	12"	1"	1	.5	\$27

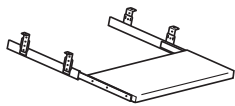

Keyboard Tray, Rollout (Specify laminate color)

Model#	Depth	Width	Height	Weight	Cube	Price
Qs MM KB	16"	21"	3"	10	.5	\$124

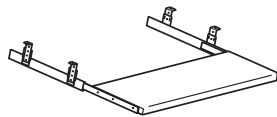

Oversize Keyboard Tray, Rollout (Specify laminate color)

Model#	Depth	Width	Height	Weight	Cube	Price
Qs MM KBLG	16"	28"	3"	12	.5	\$181

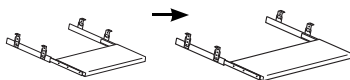

Standard Keyboard Tray to Oversize Keyboard Tray (Upgrade)

Model#	Depth	Width	Height	Weight	Price
Qs MM UKBLG	16"	28"	3"	12	\$64

Maverick Complete

Accessories and Upgrades

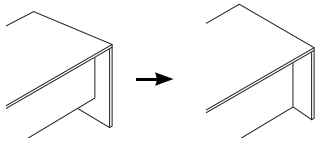

3/4 Modesty Panel Upgrade to Full Modesty Panel

Model#	Depth	Width	Height	Weight	Cube	Price
Qs MM FMP	3/4"	varies	28"	varies	varies	\$59

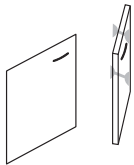

Optional Hinged Doors to Replace Sliding Doors on Storage Credenzas or Flip-up Doors on Overheads (Two doors), choice of handles

Model#	Depth	Width	Height	Weight	Cube	Price
MM UPHD2	3/4"	varies	varies	varies	varies	\$187

H3B handles standard. Handle position for credenza shown.

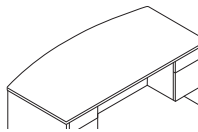

Fantop - Add (Increases depth by 6" at center on approach side)

Model#	Depth	Width	Height	Weight	Cube	Price
Qs MM FAN	varies	varies	1"	varies	varies	\$261

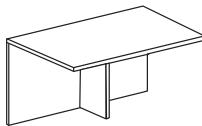

Support Panel with leveler ("Half-leg" - add to long pieces or to computer desk)

Model#	Depth	Width	Height	Weight	Cube	Price
Qs MM SPT	12"	1"	28"	11	3	\$102

Support panel can also be used to create freestanding returns. Specify location left or right 1/2 leg.

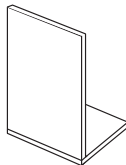

CPU Section (Add to desk, return or credenza, each) CPU1 for 3/4 height, CPU2 for full height ped

Model#	Depth	Width	Height	Weight	Cube	Price
MM CPU1	16"	10"	18 3/4"	15	2	\$103
MM CPU2	16"	10"	27 5/8"	18	3	\$129

Specify left or right mount.

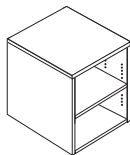

Printer Stand (Adjustable shelf, two back openings. Caster option, see below)

Model#	Depth	Width	Height	Weight	Cube	Price
MM PS2424	24"	24"	29"	65	10	\$530

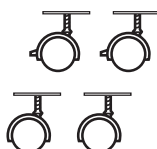

Casters, Set of Four (For stands & HDC only. Two locking, two non-locking)

Model#	Height	Price
MM CAS	2 1/2"	\$91

Maverick Complete

Accessories and Upgrades

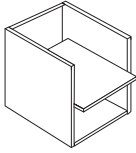

Printer Shelf with Roll-out Shelf (Add to desk, return or credenza, each)

Model#	Depth	Width	Height	Weight	Cube	Price
MM PSS	22"	24"	28"	53	10	\$343

Rollout shelf is installed 1" clear from bottom.

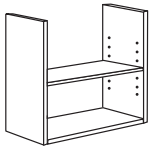

Bookcase Section (One fixed shelf, one adjustable. Add to bridge or return)

Model#	Depth	Width	Height	Weight	Cube	Price
MM BCS	12"	32"	28"	varies	varies	\$240

No back panel.



Additional Bookcase Shelf (1" -thick standard, with shelf pins)



Model#	Depth	Width	Height	Weight	Cube	Price
MM SH1	11 ¹ / ₁₆ "	33 ³ / ₄ "	1"	13	.5	\$103

Fits standard bookcases.

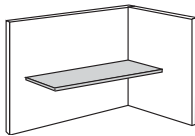

Purse Shelf (Add to desk, return or credenza)

Model#	Depth	Width	Height	Weight	Cube	Price
MM PS	10"	varies	³ / ₄ "	varies	varies	\$100

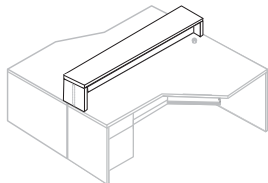

Privacy Shelf/Divider (12" counter top with centered modesty)

Model#	Depth	Width	Height	Weight	Cube	Price
MM B36	12"	36"	14"	40	4	\$304
MM B42	12"	42"	14"	40	4	\$317
MM B48	12"	48"	14"	40	4	\$330
MM B54	12"	54"	14"	41	5	\$414
MM B60	12"	60"	14"	43	5	\$491
MM B66	12"	66"	14"	49	6	\$556
MM B72	12"	72"	14"	55	6	\$621

Maverick Complete

Accessories and Upgrades

Cut Charges

Standard Cuts and Reprogramming Charges (Extends lead time)

Model#	Maverick Series Only	Price
MM CUT1	Height or Width or Depth, 90° Cut on 90° Pieces	\$91
MM CUT2	Two Dimensions, 90° Cuts on 90° Pieces	\$142
MM CUT3	Program Charge on Piece with Cut other than 90°	\$142

For Maverick Series cut charges items only.

High Pressure Laminate

HPL Tops (Maverick standard colors only. Extends lead time)

Model#		Price
MM HPLM	Matte High Pressure Laminate Top Only	Call for quote
MM HPLG	Gloss High Pressure Laminate Top Only	Call for quote
MM HPB	Backer Sheet for Underneath Side Top Only	Call for quote

Call Customer Service for quote. For custom HPL color laminates, please submit quote.

Carton

Cartoning Charges

Model#		Price
MM CAR4	Pallet Cartoning	25%

(Corner & edge protectors w/bubble/shrink wrap, place in carton, strap to pallet)



Vista Series

vis • ta: (noun)

Extensive view or an approach affording such a view.

Features

Vista is standard with full, locking pedestals and full modesty on desks, credenzas, bridges and returns. Double pedestal desk is standard with center drawer. Many other features are standard on the Vista Series.



Arched Valance



Hutch Paper Sorter



Overlay Doors on Hutches, Arched Valances on desk units and Metallic Contrasting Modesty panel



Arched Inset Modesty

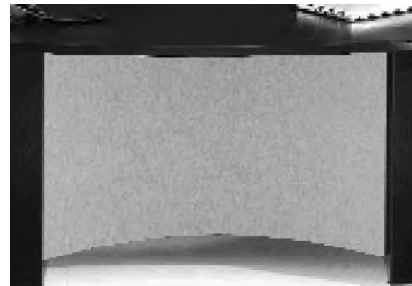

Metallic Contrasting Modesty Panel

Vista Series



10-DAY LEAD TIME

Distinct design, blending tradition and contemporary, with smart, flowing arches to accent the inset modesty panel that carry through to the hutch fascia. More than 70 modular components combine in this remarkable series to allow you to create a coordinated 72"-high executive wall with furniture to meet every need.

Product Specifications

Colors

- All 18 standard colors are available plus two designer edge band colors

Tops/Worksurfaces

- 1" TFM (Thermally Fused Melamine) on industrial quality (45 lb.) particleboard
- 2 mm thermally-fused PVC edge banding
- Metal-to-metal connection fittings are installed for bridges and returns
- Wood grain direction on tops of bridges and return runs from user side to approach side to coordinate with main unit tops



Configuration VS6 shown above.

Vista Series

Chassis Construction

- TFM (Thermally Fused Melamine) chassis fastened by screws, steel brackets, and/or concealed fasteners
- Full pedestal is standard
- Full height modesty panel is standard on all, with arch accent on all desks and on double-pedestal credenzas
- Select modesty color from five metallic HPL choices or select chassis-matching or contrasting standard color TFM at no upcharge for most desks
- 1"-thick end panels on desks and credenzas
- Visible edges are edged with 2 mm thermally-fused PVC edge banding
- Adjustable leveling glides on all units designed to set on the floor
- Hutches for Vista Series are designed to fit Vista Series ONLY and feature full overlay doors, arch accent and paper sorter
- Product heights are coordinated to facilitate matching at 72 inches
- Standard woodgrain direction on the modesty of hutches and credenzas is horizontal

Drawer Interiors

- 9-ply Birch wood drawers

Drawer Suspension, Construction and Doors

- File and box drawers have full-extension, progressive-action slides with precision steel ball bearings.
- Heavy duty file rods in file drawers
- The overlay drawer fronts and doors are provided with customer's choice of handles standard (except for hutch)
- The overlay doors of the hutch feature a recessed finger pull. Optional handles may be added. See page 123 for prices
- Each desk is provided with one box drawer convenience tray. See page 124 for optional additional trays for other units
- Optional glass doors available, see page 121

Cord Management

- Black grommets are standard on worksurface and modesty of computer units, returns and credenzas. Hutches feature two rectangular black grommets on the back. Silver grommet cover upgrade is available at N/C
- Optional wire management is available - grommets on page 124

Locks

- Standard on all except storage credenza, (VSCE2472BSB), and hutches. See optional locks on page 124.
- Black or silver, removable cores are standard for all locks
- Pedestal key numbers are randomly assigned to all locking pedestals, except that double pedestal units will be keyed alike
- Master keys and keyed-alike combinations are available

Disclaimer: Dimensions assigned in this price list are nominal. If exact measurements are required, the requirement must be specified in the order and specifically acknowledged by Maverick. Maverick reserves the right to change construction details and standards without notification, if necessary.



Vista Series

How to Order Vista Series

WORKSURFACE UNITS: DESKS, CREDENZAS AND RETURNS

Vista Series

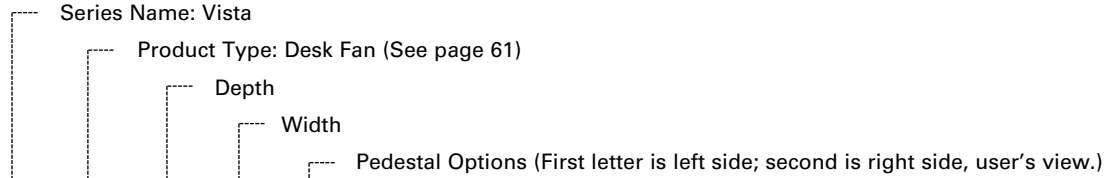

1. Product number: **VS DF 36 72 BB**
2. Specify Worksurface Finish. See back cover.
3. Specify Worksurface Edge Banding Finish. Matching color edge banding is standard. See back cover.
4. Specify Chassis Finish. Matching color edge banding is standard. See back cover.
5. Specify Handle Options. Choice of handle is standard (except hutch). See below and page 123.
6. Specify Modesty Color. See below and page 122.
7. Specify Other Accessories or Upgrades. See below and page 123-124.

HANDLE UPGRADE OPTIONS:

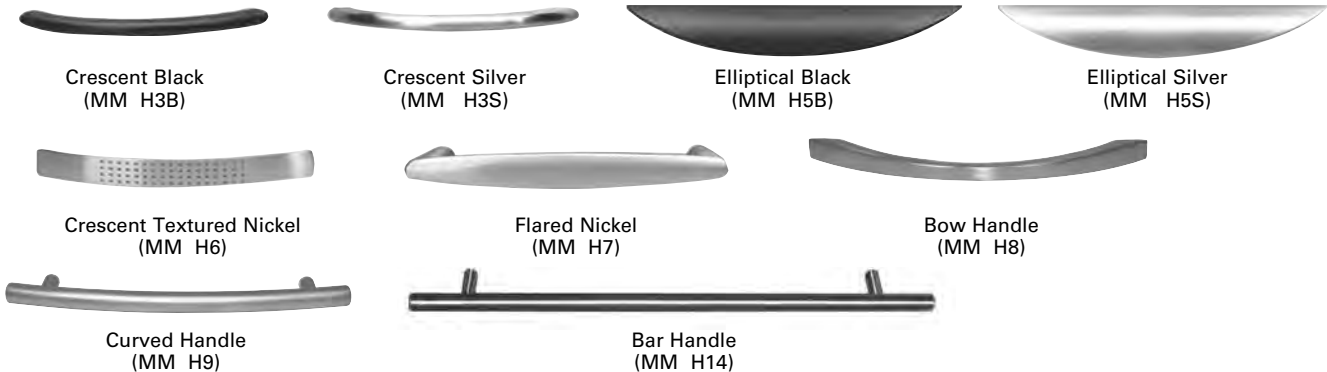

IMPORTANT NOTE: Choice of handle is standard (except hutch). See page 123 for additional handle options and prices.

MODESTY COLORS: See page 122

- VS MOD1 - Same as Chassis
- VS MOD2 - Other Standard Color (TFL)
- VS MOD3 - Grayte Textured
- VS MOD4 - Pewter Brush
- VS MOD5 - Silver Matte
- VS MOD6 - Brushed Aluminum
- VS MOD7 - Aluminum Dots

EDGE PROFILE:

SIDE VIEW:



PEDESTAL/BASE OPTIONS:

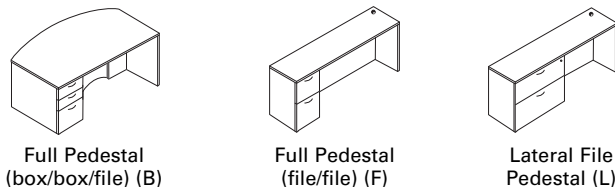

HUTCH BACK

WORKSURFACE



Black grommet is standard. Upgrade to silver color, N/C.

Grommets (WORKSURFACE)

Note: While sitting at unit, grommet locations named from left to right.
 For grommet location on tops and/or modesty panel specify left, center or right.
No grommets over pedestals.

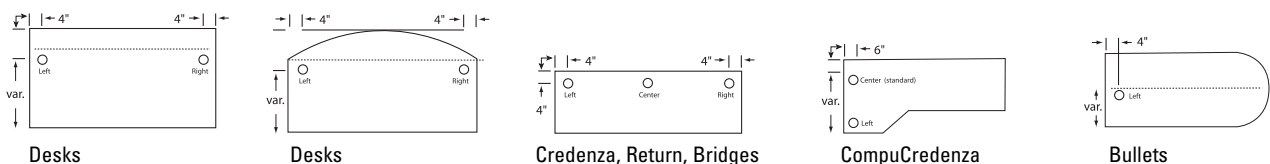

Vista Series

Statement of Line

DESKS:

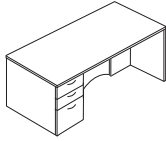

Desk - Rect. sgl. ped.
(DE___BX)

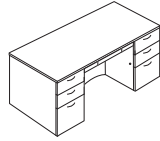

Desk - Rect. dbl. ped.
(DE___BB)

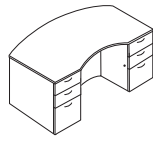

Desk Fan Top - Center cutout
(DC___BB)

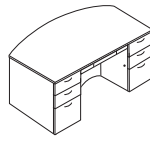

Desk Fan Top - Dbl. ped.
(DF___BB)

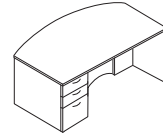

Desk Fan Top - Sgl. ped.
(DFF___BX)

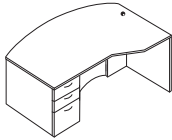

Fan Top Comp. Desk Angled - Sgl. ped.
(CDF)

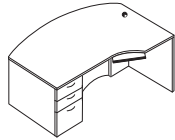

Fan Top Comp. Desk Curved- Sgl. ped.
(CDFQ)

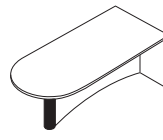

Desk - Bullet
(DB)

BRIDGE:

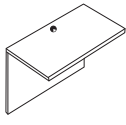

Return - Bridge
(RB)

RETURNS:

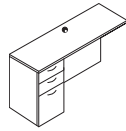

Return - Box/box/file
(RL___BX)

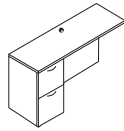

Return - File/file
(RL___FX)

FILING:

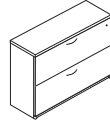

Lateral File
(LF2)

CREDENZAS:

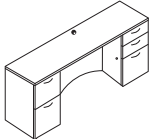

Credenza - Dbl. ped.
(CE___FB)

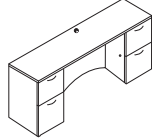

Credenza - Dbl. ped.
(CE___FF)

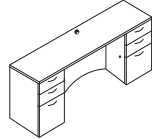

Credenza - Dbl. ped.
(CE___BB)

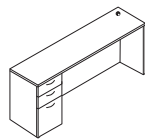

Credenza - Sgl. ped.
(CE___BX)

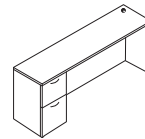

Credenza - Sgl. ped.
(CE___FX)

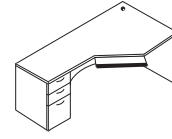

Corner Credenza - Sgl. ped.
(CL___BX)

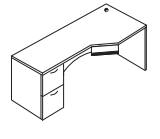

Corner Credenza - Sgl. ped.
(CL___FX)

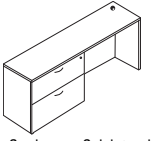

Credenza - Sgl. lateral
(CE___LX)

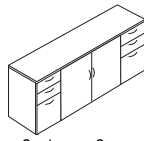

Credenza - Storage
(CE___BSB)

HUTCHES:

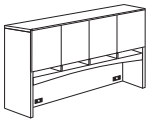

Hutch - With doors
(HD)

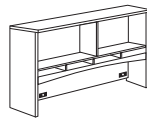

Hutch - For glass
(H___ND4)

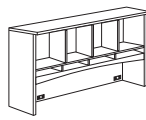

Hutch - For glass
(H___ND2)



Hutch Bookcase
(HB)

CABINETS:

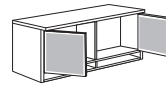

Cabinets - Overhead for Glass
(CFOHG36)

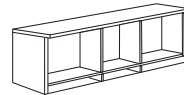

Cabinets - Overhead for Glass
(CFOHG48)

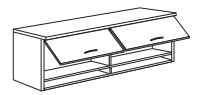

Cabinet - Overhead
(CFOHB)

BOOKCASES:

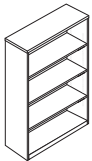

Bookcase
(BC)

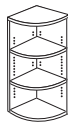

Bookcase - Upper
(BCC)

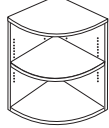

Bookcase - Lower
(BCC)

STORAGE:

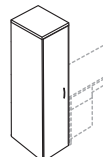

Storage - Single tower
(STS)

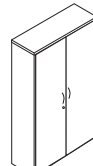

Storage - Double Tower
(TD)

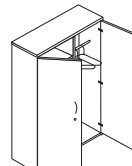

Storage - Wardrobe
(WC)

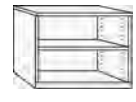

Utility Cabinet - For glass
(HDC)

DOORS:

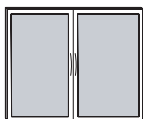

Doors - Glass with silver vinyl wrapped frame
(VW15/VW30/VW52)
No handles on VW15

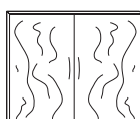

Doors - Wood (TFM)
(WD15/WD30/WD52)



Vista Series

Configurations - All are available on **10 Day**

Vista Series

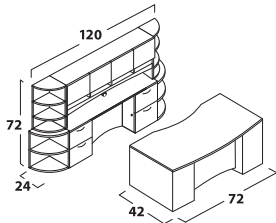

VS1

1	VSDC4272BB	\$2,161
1	VSCE2472FF	\$1,714
1	VSHD1672	\$1,618
1	VSBR1542	\$459
1	VSBRR1542	\$459
1	VSBR12430	\$594
1	VSBRR12430	\$594
	\$7,599	

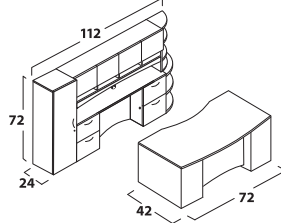

VS2

1	VSDC4272BB	\$2,161
1	VSCE2472FF	\$1,714
1	VSHD1672	\$1,618
1	VSBR1542	\$459
1	VSBRR1542	\$459
1	VSL22436L	\$905
1	VSTL2472	\$996
	\$7,542	

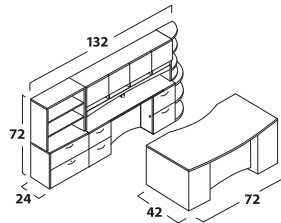

VS3

1	VSDC4272BB	\$2,161
1	VSCE2472FF	\$1,714
1	VSHD1672	\$1,618
1	VSBR1542	\$459
1	VSBRR1542	\$459
1	VSL22436L	\$905
1	VSHB1542	\$577
	\$8,028	

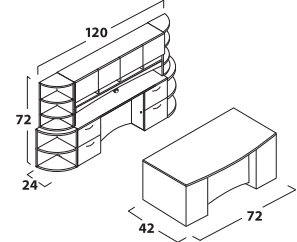

VS4

1	VSDC4272BB	\$2,233
1	VSCE2472FF	\$1,714
1	VSHD1672	\$1,618
1	VSBR1542	\$459
1	VSBRR1542	\$459
1	VSBR12430	\$594
1	VSBRR12430	\$594
	\$7,671	

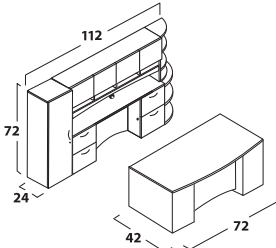

VS5

1	VSDC4272BB	\$2,233
1	VSCE2472FF	\$1,714
1	VSHD1672	\$1,618
1	VSBR1542	\$459
1	VSBRR1542	\$459
1	VSL22436L	\$905
1	VSTL2472	\$996
	\$7,614	

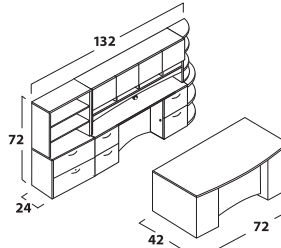

VS6

1	VSDC4272BB	\$2,233
1	VSCE2472FF	\$1,714
1	VSHD1672	\$1,618
1	VSBR1542	\$459
1	VSBRR1542	\$459
1	VSL22436L	\$905
1	VSHB1542	\$577
	\$8,100	

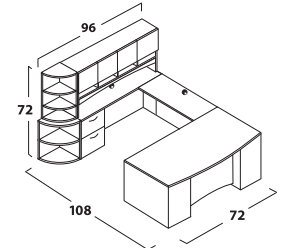

VS7L

1	VSCE2472FX	\$1,313
1	VSHD1672	\$1,714
1	VSBR2448	\$446
1	VSDC3672XB	\$1,352
1	VSBR1542	\$459
1	VSBR12430	\$594
	\$5,878	

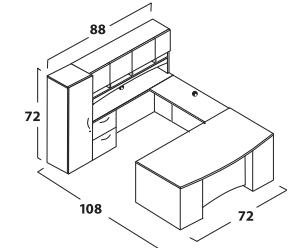

VS8L

1	VSCE2472FX	\$1,313
1	VSHD1672	\$1,714
1	VSBR2448	\$446
1	VSDC3672XB	\$1,352
1	VSTL2472	\$996
	\$5,821	

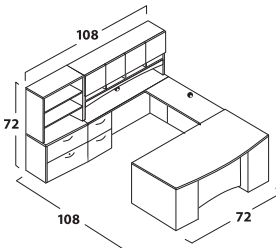

VS9L

1	VSCE2472FX	\$1,313
1	VSHD1672	\$1,714
1	VSBR2448	\$446
1	VSDC3672XB	\$1,352
1	VSL22436L	\$905
1	VSHB1542	\$577
	\$6,307	

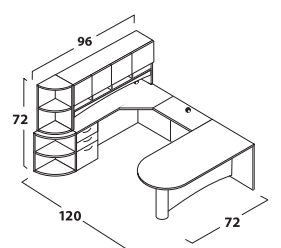

VS10L

1	VSDC2472BX	\$1,515
1	VSHD1672	\$1,714
1	VSBR2448	\$446
1	VSDC3672	\$1,081
1	VSBR1542	\$459
1	VSBR12430	\$594
	\$5,809	

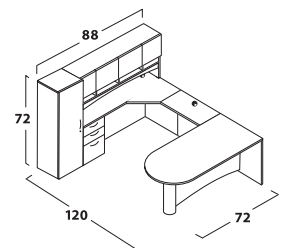

VS11L

1	VSDC2472BX	\$1,515
1	VSHD1672	\$1,714
1	VSBR2448	\$446
1	VSDC3672	\$1,081
1	VSTL2472	\$996
	\$5,752	

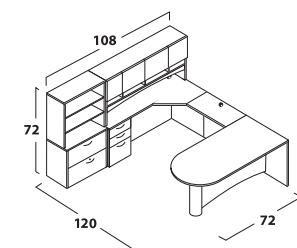

VS12L

1	VSDC2472BX	\$1,515
1	VSHD1672	\$1,714
1	VSBR2448	\$446
1	VSDC3672	\$1,081
1	VSL22436L	\$905
1	VSHB1542	\$577
	\$6,238	

Use "R" or "L" to indicate the position of the return. Configurations are a small sample of total available.

Vista Series



Desks

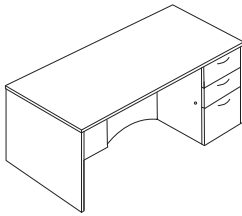

Single Pedestal Desk, Box/Box/File, Right

Model#	Depth	Width	Height	Weight	Cube	Price
VSDE3060XB	30"	60"	29"	267	38	\$1,164
VSDE3072XB	30"	72"	29"	277	45	\$1,281
VSDE3672XB	36"	72"	29"	287	52	\$1,301

Add modesty color option, no charge, p. 122.

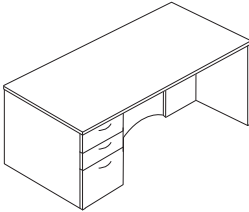

Single Pedestal Desk, Box/Box/File, Left

Model#	Depth	Width	Height	Weight	Cube	Price
VSDE3060BX	30"	60"	29"	267	38	\$1,164
VSDE3072BX	30"	72"	29"	277	45	\$1,281
VSDE3672BX	36"	72"	29"	287	52	\$1,301

Add modesty color option, no charge, p. 122.

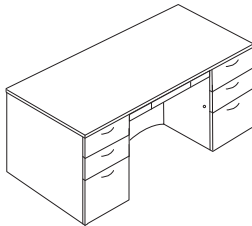

Double Pedestal Desk, Box/Box/File Pedestals, Left and Right (Center Drawer)

Model#	Depth	Width	Height	Weight	Cube	Price
VSDE3060BB	30"	60"	29"	267	38	\$1,715
VSDE3072BB	30"	72"	29"	277	45	\$1,844
VSDE3672BB	36"	72"	29"	287	52	\$1,883

Add modesty color option, no charge, p. 122.

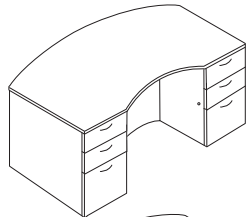

Double Pedestal Fan Top Desk, Center Cutout, Box/Box/File, Left and Right

Model#	Depth	Width	Height	Weight	Cube	Price
VSDC4272BB	36-42"	72"	29"	332	52	\$2,161

Add modesty color option, no charge, p. 122.

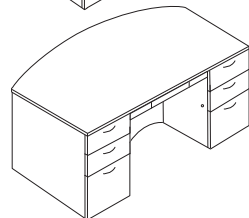

Double Pedestal Fan Top Desk, Box/Box/File Left and Right (Center drawer)

Model#	Depth	Width	Height	Weight	Cube	Price
VSDF3672BB	30-36"	72"	29"	332	45	\$1,928
VSDF4272BB	36-42"	72"	29"	342	52	\$2,233

Add modesty color option, no charge, p. 122.

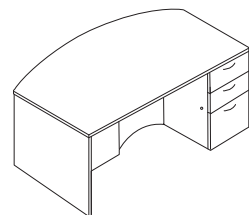

Single Pedestal Fan Top Desk, Box/Box/File, Right

Model#	Depth	Width	Height	Weight	Cube	Price
VSDF3672XB	30-36"	72"	29"	277	45	\$1,352
VSDF4272XB	36-42"	72"	29"	287	52	\$1,670

Add modesty color option, no charge, p. 122.

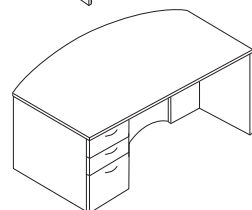

Single Pedestal Fan Top Desk, Box/Box/File, Left

Model#	Depth	Width	Height	Weight	Cube	Price
VSDF3672BX	30-36"	72"	29"	277	45	\$1,352
VSDF4272BX	36-42"	72"	29"	287	52	\$1,670

Add modesty color option, no charge, p. 122.

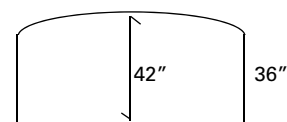
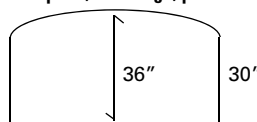

See available accessories, pp. 123-124



Vista Series

Desks

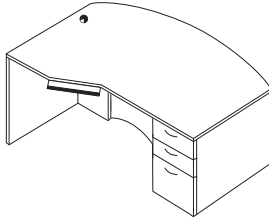

Fan Top Computer Desk, Box/Box/File Pedestal (Front unit, full modesty), Right

Model#	(L)	(B)	(E)	(K)	(R)	(W)	Weight	Cube	Price
VSCDF72 9R	72"	42"+	30"	24"	24"	27"	295	60	\$1,483

Keyboard tray and worksurface black grommet are standard.

Add modesty color option, no charge, see p. 122. Upgrade grommet cover to silver, N/C.

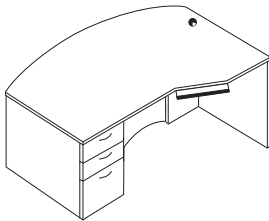

Fan Top Computer Desk, Box/Box/File Pedestal (Front unit, full modesty), Left

Model#	(L)	(B)	(E)	(K)	(R)	(W)	Weight	Cube	Price
VSCDF72 9L	72"	42"+	30"	24"	24"	27"	295	60	\$1,483

Keyboard tray and worksurface black grommet are standard.

Add modesty color option, no charge, see p. 122. Upgrade grommet cover to silver, N/C.

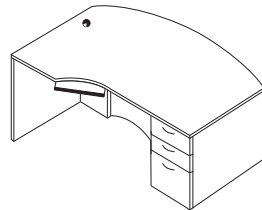

Fan Top Computer Desk, Curved, Box/Box/File Pedestal (full modesty), Right

Model#	(L)	(B)	(E)	(K)	(R)	(W)	Weight	Cube	Price
VSCDFQ72 9R	72"	42"+	30"	24"	24"	27"	295	60	\$1,483

Keyboard tray and worksurface black grommet are standard.

Add modesty color option, no charge, see p. 122. Upgrade grommet cover to silver, N/C.

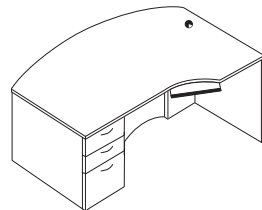

Fan Top Computer Desk, Curved, Box/Box/File Pedestal (full modesty), , Left

Model#	(L)	(B)	(E)	(K)	(R)	(W)	Weight	Cube	Price
VSCDFQ72 9L	72"	42"+	30"	24"	24"	27"	295	60	\$1,483

Keyboard tray and worksurface black grommet are standard.

Add modesty color option, no charge, see p. 122. Upgrade grommet cover to silver, N/C.

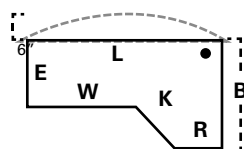

- "L" Length along approach edge
- "B" Back end panel (Fan top adds 6")
- "E" End panel
- "K" Keyboard space
- "R" Return size to attach
- "W" Workarea (kbrd to end)

Vista Series



Desks, Bridges, Returns

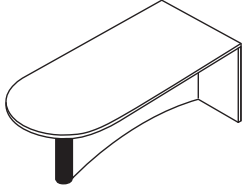

Bullet Desk with 4" Black Metal Leg (Full, arched modesty), For Right Return

Model #	Depth	Width	Height	Weight	Cube	Price
VSDBR3072	30"	72"	29"	147	37	\$919
VSDBR3672	36"	72"	29"	157	45	\$1,081

Optional metallic inset modesty VS UMOD, add \$332, see page 122. Upgrade to silver color leg, MMUHLEGJS...N/C.

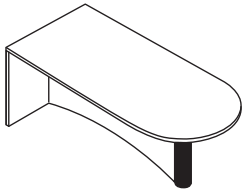

Bullet Desk with 4" Black Metal Leg (Full, arched modesty), For Left Return

Model #	Depth	Width	Height	Weight	Cube	Price
VSDBL3072	30"	72"	29"	147	37	\$919
VSDBL3672	36"	72"	29"	157	45	\$1,081

Optional metallic inset modesty VS UMOD, add \$332, see page 122. Upgrade to silver color leg, MMUHLEGJS...N/C.

Bridges

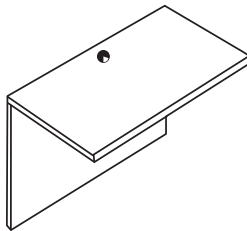

Bridge Section, Component (Full modesty panel)

Model#	Depth	Width	Height	Weight	Cube	Price
VSRB2436	24"	36"	29"	90	16	\$376
VSRB2442	24"	42"	29"	90	18	\$432
VSRB2448	24"	48"	29"	100	20	\$446
VSRB2454	24"	54"	29"	100	22	\$459

Worksurface and modesty black grommet standard. Upgrade grommet cover to silver, N/C.

Returns

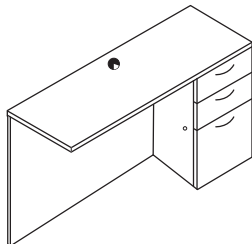

Return, Box/Box/File Pedestal (Full modesty panel), Right

Model#	Depth	Width	Height	Weight	Cube	Price
VSRR2036XB	20"	36"	29"	115	9	\$951
VSRR2042XB	20"	42"	29"	125	10	\$951
VSRR2048XB	20"	48"	29"	135	12	\$964
VSRR2054XB	20"	54"	29"	145	14	\$996
VSRR2436XB	24"	36"	29"	155	16	\$951
VSRR2442XB	24"	42"	29"	165	18	\$1,035
VSRR2448XB	24"	48"	29"	175	20	\$1,048

Worksurface and modesty black grommet standard. Upgrade grommet cover to silver, N/C.

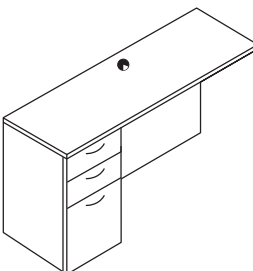

Return, Box/Box/File Pedestal (Full modesty panel), Left

Model#	Depth	Width	Height	Weight	Cube	Price
VSRL2036BX	20"	36"	29"	115	9	\$951
VSRL2042BX	20"	42"	29"	125	10	\$951
VSRL2048BX	20"	48"	29"	135	12	\$964
VSRL2054BX	20"	54"	29"	145	14	\$996
VSRL2436BX	24"	36"	29"	155	16	\$951
VSRL2442BX	24"	42"	29"	165	18	\$1,035
VSRL2448BX	24"	48"	29"	175	20	\$1,048

Worksurface and modesty black grommet standard. Upgrade grommet cover to silver, N/C.

See available accessories, pp. 123-124



Vista Series

Returns, Credenzas

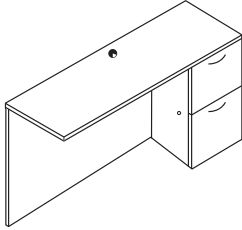

Return, File/File Pedestal (Full modesty panel), Right

Model#	Depth	Width	Height	Weight	Cube	Price
VSRR2036XF	20"	36"	29"	145	13	\$919
VSRR2042XF	20"	42"	29"	155	15	\$919
VSRR2048XF	20"	48"	29"	165	17	\$937
VSRR2054XF	20"	54"	29"	175	19	\$964
VSRR2436XF	24"	36"	29"	155	15	\$918
VSRR2442XF	24"	42"	29"	165	18	\$1,009
VSRR2448XF	24"	48"	29"	175	20	\$1,023

Worksurface and modesty black grommet standard. Upgrade grommet cover to silver, N/C.

Return, File/File Pedestal (Full modesty panel), Left

Model#	Depth	Width	Height	Weight	Cube	Price
VSRL2036FX	20"	36"	29"	145	13	\$919
VSRL2042FX	20"	42"	29"	155	15	\$919
VSRL2048FX	20"	48"	29"	165	17	\$937
VSRL2054FX	20"	54"	29"	175	19	\$964
VSRL2436FX	24"	36"	29"	155	15	\$918
VSRL2442FX	24"	42"	29"	165	18	\$1,009
VSRL2448FX	24"	48"	29"	175	20	\$1,023

Worksurface and modesty black grommet standard. Upgrade grommet cover to silver, N/C.

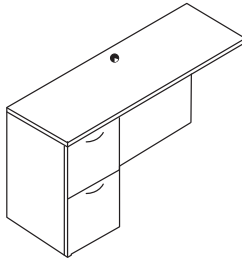

Credenzas

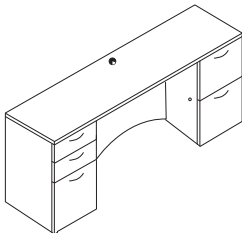

Credenza, Double Pedestal (Kneespace), Box/Box/File Left, File/File Right

Model#	Depth	Width	Height	Weight	Cube	Price
VSCE2472BF	24"	72"	29"	223	30	\$1,740

Worksurface and modesty black grommet standard. Upgrade grommet cover to silver, N/C.
Optional metallic inset modesty VS UMOD, add \$332, see page 122.

Credenza, Double Pedestal (Kneespace), Box/Box/File Right, File/File Left

Model#	Depth	Width	Height	Weight	Cube	Price
VSCE2472FB	24"	72"	29"	223	30	\$1,740

Worksurface and modesty black grommet standard. Upgrade grommet cover to silver, N/C.
Optional metallic inset modesty VS UMOD, add \$332, see page 122.

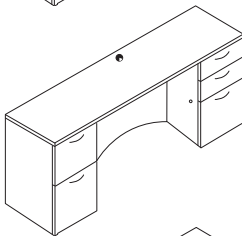

Credenza, Double Pedestal (Kneespace), File/File Left and Right

Model#	Depth	Width	Height	Weight	Cube	Price
VSCE2472FF	24"	72"	29"	223	30	\$1,714

Worksurface and modesty black grommet standard. Upgrade grommet cover to silver, N/C.
Optional metallic inset modesty VS UMOD, add \$332, see page 122.

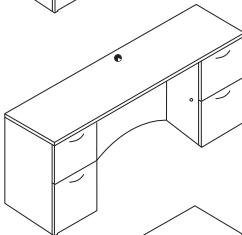

Credenza, Double Pedestal (Kneespace), Box/Box/File Left and Right

Model#	Depth	Width	Height	Weight	Cube	Price
VSCE2472BB	24"	72"	29"	223	30	\$1,773

Worksurface and modesty black grommet standard. Upgrade grommet cover to silver, N/C.
Optional metallic inset modesty VS UMOD, add \$332, see page 122.

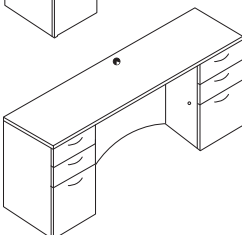

Vista Series



Credenzas

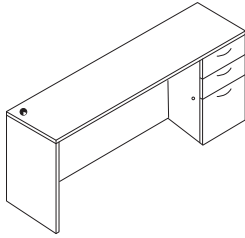

Credenza, Single Box/Box/File Pedestal, Right

Model#	Depth	Width	Height	Weight	Cube	Price
VSCE2472XB	24"	72"	29"	178	30	\$1,515

Worksurface and modesty black grommet standard. Upgrade grommet cover to silver, N/C.

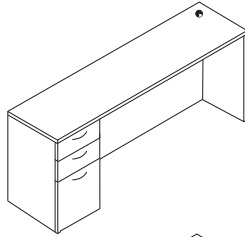

Credenza, Single Box/Box/File Pedestal, Left

Model#	Depth	Width	Height	Weight	Cube	Price
VSCE2472BX	24"	72"	29"	178	30	\$1,515

Worksurface and modesty black grommet standard. Upgrade grommet cover to silver, N/C.

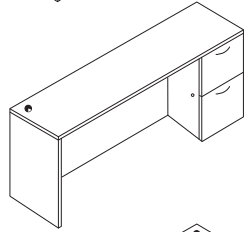

Credenza, Single File/File Pedestal, Right

Model#	Depth	Width	Height	Weight	Cube	Price
VSCE2472XF	24"	72"	29"	166	30	\$1,313

Worksurface and modesty black grommet standard. Upgrade grommet cover to silver, N/C.

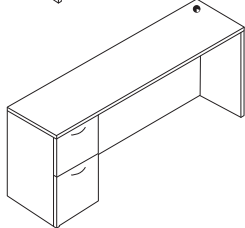

Credenza, Single File/File Pedestal, Left

Model#	Depth	Width	Height	Weight	Cube	Price
VSCE2472FX	24"	72"	29"	166	30	\$1,313

Worksurface and modesty black grommet standard. Upgrade grommet cover to silver, N/C.

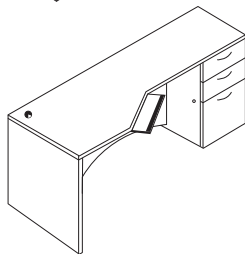

Credenza, Corner, Box/Box/File Pedestal (Keyboard tray), Right

Model#	Depth	Width	Height	Weight	Cube	Price
VSCR2472XB	24"	72"	29"	210	52	\$1,515

Keyboard tray and worksurface black grommet standard. Approach side w/step front and arched modesty. Upgrade grommet cover to silver, N/C.

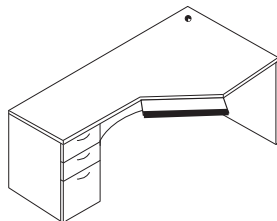

Credenza, Corner, Box/Box/File Pedestal (Keyboard tray), Left

Model#	Depth	Width	Height	Weight	Cube	Price
VSCL2472BX	24"	72"	29"	210	52	\$1,515

Keyboard tray and worksurface black grommet standard. Approach side w/step front and arched modesty. Upgrade grommet cover to silver, N/C.

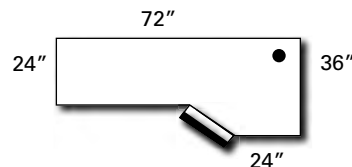



Vista Series

Credenzas

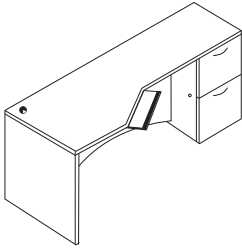

Credenza, Corner, File/File Pedestal (Keyboard tray), Right

Model#	Depth	Width	Height	Weight	Cube	Price
VSCR2472XF	24"	72"	29"	195	52	\$1,483

Keyboard tray and worksurface black grommet standard. Approach side w/step front and arched modesty.
Upgrade grommet cover to silver, N/C.

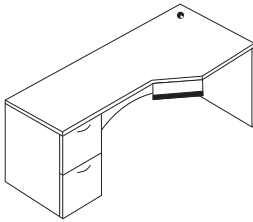

Corner Credenza with File/File Pedestal (Keyboard tray), Left

Model#	Depth	Width	Height	Weight	Cube	Price
VSCL2472FX	24"	72"	29"	195	52	\$1,483

Keyboard tray and worksurface black grommet standard. Approach side w/step front and arched modesty.
Upgrade grommet cover to silver, N/C.

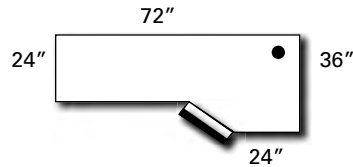

Credenza with 36" Wide Lateral File, Right

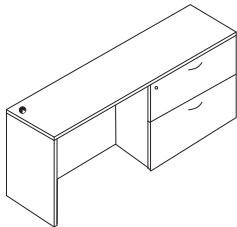

Model#	Depth	Width	Height	Weight	Cube	Price
VSCE2472XL	24"	72"	29"	260	30	\$1,605

Worksurface and modesty black grommet standard. Upgrade grommet cover to silver, N/C.

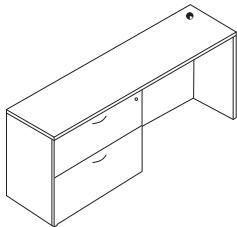

Credenza with 36" Wide Lateral File, Left

Model#	Depth	Width	Height	Weight	Cube	Price
VSCE2472LX	24"	72"	29"	260	30	\$1,605

Worksurface and modesty black grommet standard. Upgrade grommet cover to silver, N/C.

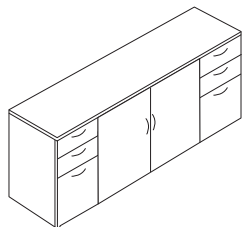

Center Storage Credenza with Left and Right Box/Box/File (One adjustable shelf)

Model#	Depth	Width	Height	Weight	Cube	Price
VSCE2472BSB	24"	72"	29"	260	30	\$2,323

FOR HINGED DOORS:
Optional Face Locks available, add MM FL...\$71 each.

FOR PEDESTALS:
Optional Pedestal Lock available, add MM PL...\$71 each.
Pedestal locks are located inside hinged doors.

Vista Series



Filing, Hutches

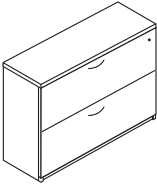

Lateral File (Choice of handle, lock)

Model#	Depth	Width	Height	Weight	Cube	Price
VSL22436L	24"	36"	29"	160	15	\$905

Accommodates VSHB. For H30 Handle...add \$56 each.

Hutches

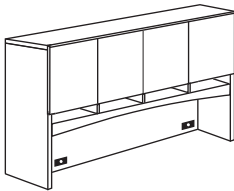

Hutch with TFM Doors (18" clearance below fascia center)

Model#	Depth	Width	Height	Weight	Cube	Price
VSHD1672	15"+	72"	42"	215	28	\$1,618

Vista Series hutch fits Vista Series worksurfaces only. Optional locks - two required, add MM FL...\$71 each. For Tasklight, add VSTSKLT...\$315. Add tackboards, see p. 121. Sides are 15" deep. The overlay doors add 3/4"+. Add 25% for HPL White Gloss doors with Brushed metal edge banding.

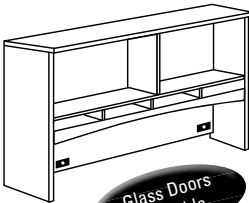

Hutch, No Doors (Doors NOT included, Top overhangs legs 1")

Model#	Depth	Width	Height	Weight	Cube	Price
VSH72ND4	16"	72"	42"	215	26	\$1,269

Optional doors available, see p. 121. Clearance below valance at center is 18". For Tasklight, add VSTSKLT...\$315. Add tackboards, see p. 121. VSH72ND4 is designed to accept 4 doors only.



Hutch, No Doors (Doors NOT included, Top overhangs legs 1")

Model#	Depth	Width	Height	Weight	Cube	Price
VSH72ND2	16"	72"	42"	215	26	\$1,301

Optional doors available, see p. 121. Clearance below valance at center is 18". VSH72ND2 is designed to accept two doors only. Standard location for 2 doors is mounted on left and right legs. For Tasklight, add VSTSKLT...\$315.

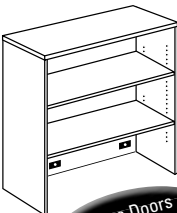

Bookcase Hutch (One fixed, One adjustable shelf. 1"-thick shelves, back panel grommets)

Model#	Depth	Width	Height	Weight	Cube	Price
VSHB1542	15"	36"	42"	86	14	\$577
VSHB1552	15"	36"	52"	102	18	\$647

Note: VSHB1552 - Top overhangs legs 1" and has one fixed and one adjustable shelf. Clearance below fixed shelf is 12". Optional glass doors for VSHB1552 only, p. 121. Coordinates with Vista hutch depth.

Storage

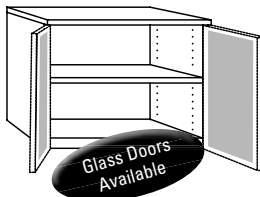

Utility Cabinet (Doors NOT included, One adjustable 1"-thick shelf, top overhangs legs 1")

Model#	Depth	Width	Height	Weight	Cube	Price
VSHDC2436	24"	36"	29"	110	14	\$434

For glass doors, add VSVW30...\$615. For TFM doors, add VSWD30...\$323. See page 121.



Vista Series

Storage

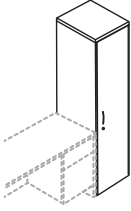

Single Storage Cabinet, Right (Choice of handle, lock, four adjustable shelves)

Model#	Depth	Width	Height	Weight	Cube	Price
VSTR2472	24"	16"	72"	150	16	\$996

Add 25% for HPL White Gloss doors with Brushed metal edge banding.
For H30 handle, add \$.56 each.

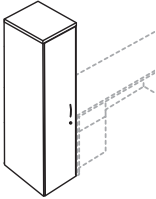

Single Storage Cabinet, Left (Choice of handle, lock, four adjustable shelves)

Model#	Depth	Width	Height	Weight	Cube	Price
VSTL2472	24"	16"	72"	150	16	\$996

Add 25% for HPL White Gloss doors with Brushed metal edge banding.
For H30 handle, add \$.56 each.



Storage Cabinet over 36"-wide Lateral File (Locks, two adjustable shelves, choice of handle)

Model#	Depth	Width	Height	Weight	Cube	Price
VSTD2472L	24"	36"	72"	330	36	\$1,961

Add 25% for HPL White Gloss doors with Brushed metal edge banding.
For H30 handle, add \$.56 each.

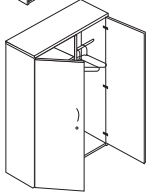

Wardrobe Cabinet (lock, coat rack on right, three adjustable shelves on left, choice of handle)

Model#	Depth	Width	Height	Weight	Cube	Price
VSTW2472	24"	36"	72"	310	36	\$1,805

Add 25% for HPL White Gloss doors with Brushed metal edge banding.
For H30 handle, add \$.56 each.

Reception

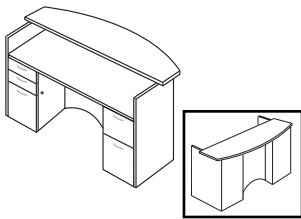

Reception Double Pedestal Desk, Inset Modesty front, (File/File Right, Box/Box/File Left, Bow-front counter top 12" deep, approach overhangs 6")

Model#	Depth	Width	Height	Weight	Cube	Price
VSRCAD3072	30/36"	72"	42"	455	67	\$2,717

Optional metallic inset modesty VS UMOD, add \$355, see p. 122.

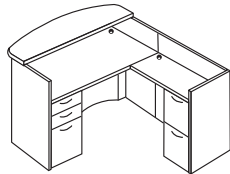

Reception "L" Unit, Solid One-Piece Front, Right Return 24" x 48"* (Desk counter only)

Model#	Depth	Width	Height	Weight	Cube	Price
VSRCAX3072 R	84"	72"	42"	425	92	\$3,365

Counter top is 12" deep. Counter top approach overhang is 6". Worksurface grommets standard.
Transaction counter-to-desktop clearance is 11 3/4". Optional metallic inset modesty VS UMOD, add \$355, see p. 122.
Upgrade grommet cover to silver, N/C.

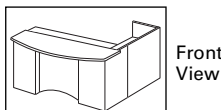

Front View

Reception "L" Unit, Solid One-Piece Front, Left Return 24" x 48"* (Desk counter only)

Model#	Depth	Width	Height	Weight	Cube	Price
VSRCAX3072 L	84"	72"	42"	425	92	\$3,365

Counter top is 12" deep. Counter top approach overhang is 6". Worksurface grommets standard.
Transaction counter-to-desktop clearance is 11 3/4". Optional metallic inset modesty VS UMOD, add \$355, see p. 122.
Upgrade grommet cover to silver, N/C.

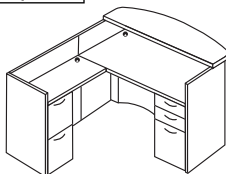

Vista Series



Bookcases

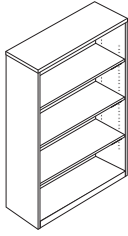

Bookcase (Four adjustable 1"-thick shelves)

Model#	Depth	Width	Height	Weight	Cube	Price
VSBC1572	15"	36"	72"	118	18	\$895

Coordinates with Vista Series hutch depth.

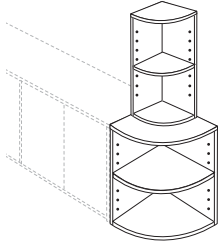

Bookcase, Corner, Right (Order separately, 1"-thick shelves)

Model#	Depth	Width	Height	Weight	Cube	Price
VSBRR1542	15"	15"	42"	68	6	\$459
VSBRR2430	24"	24"	29"	100	10	\$594

VSBRR1542 coordinates with Vista Series hutch depth and height.

VSBRR2430 coordinates with Vista Series credenza depth.

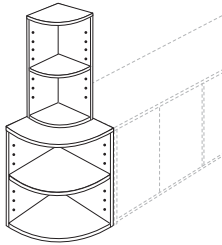

Bookcase, Corner, Left (Order separately, 1"-thick shelves)

Model#	Depth	Width	Height	Weight	Cube	Price
VSBRL1542	15"	15"	42"	68	6	\$459
VSBRL2430	24"	24"	29"	100	10	\$594

VSBRR1542 coordinates with Vista Series hutch depth and height.

VSBRR2430 coordinates with Vista Series credenza depth.

Cabinets

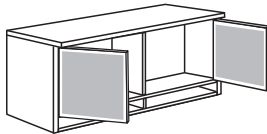

VSCFOHG36

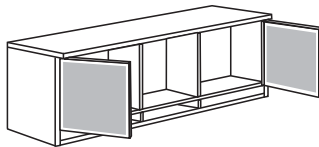

VSCFOHG48

Overhead Wall Mounted Cabinet (With glass or TFM doors, mail slots)

Model#	Depth	Width	Height	Weight	Cube	Price
VSCFOHG36 _(TFM)	16"	36"	21"	95	7	\$1,081
VSCFOHG48 _(TFM)	16"	48"	21"	110	9	\$1,145
VSCFOHG36 _(Glass)	16"	36"	21"	95	7	\$1,294
VSCFOHG48 _(Glass)	16"	48"	21"	110	9	\$1,358

Limited weight capacity. Requires professional installation and must be mounted to wall stud.

VSCFOHG48 takes 2 glass doors and has an 11" center opening. Face locks available for TFM doors only, add MM FL...\$71/each (36" cabinets require one lock).

Overhead Wall-Mounted Cabinet (Two flip doors, two mail slots)

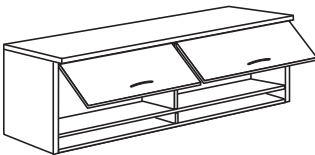

Model#	Depth	Width	Height	Weight	Cube	Price
VSCFOHB48	16"	48"	21"	130	8	\$1,099
VSCFOHB60	16"	60"	21"	145	10	\$1,164

Optional hinged doors, add MM UPHD2...\$187. Optional locks are available, two locks required, add MM FL...\$71 each. Limited weight capacity. Requires professional installation and must be mounted to wall stud.



Vista Series

Door Options, Accessories for Hutches & Cabinets

VS WD15

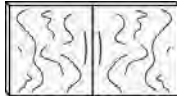

VS VW15

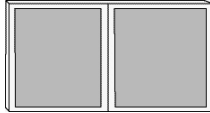

Hutch Doors, Pair (Solid TFM in choice of colors; Frosted glass with silver vinyl-wrapped MDF frame)

Model#	Depth	Width	Height	Weight	Cube	Price
VS WD15	3/4"	36"	15"	11	1	\$177
VS VW15	3/4"	36"	15"	10	1	\$388

No handles available for 15" doors, except TFM doors. Designed to fit VSH72ND2, VSH72ND4, VSCFOHG36 and VSCFOHG48. Order one pair for VSOH72ND2. Order two pair for VSH72ND4.
Optional Face lock available for wood TFM doors only, add MM FL...\$66.

VS WD30

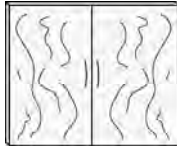

VS VW30



Utility Cabinet Doors, Pair (Solid TFM in choice of colors; Frosted glass with silver vinyl-wrapped MDF frame, select handles)

Model#	Depth	Width	Height	Weight	Cube	Price
VS WD30	3/4"	36"	30"	22	1	\$323
VS VW30	3/4"	36"	30"	20	1	\$615

Designed to fit VSHDC2436. Optional Face lock available for wood TFM doors only, add MM FL...\$66.
Choose handles from H3, H5, H6, H7, H8, H9 and H14 only.

VS WD52

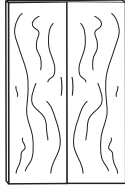

VS VW52

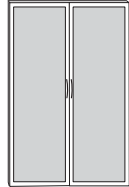

Bookcase Hutch Doors, Pair (Solid TFM in choice of colors; Frosted glass with silver vinyl-wrapped MDF frame, select handles)

Model#	Depth	Width	Height	Weight	Cube	Price
VS WD52	3/4"	36"	52"	30	1	\$388
VS VW52	3/4"	36"	52"	28	1	\$1,094

Designed to fit VSBCH3652. Optional Face lock available for wood TFM doors only, add MM FL...\$66.
Choose handles from H3, H5, H6, H7, H8, H9 and H14 only.

Accessories for Hutches

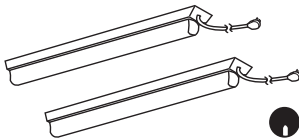

Tasklight (Black, two lights, interconnected) with grommet on hutch back

Model#	Depth	Width	Height	Weight	Cube	Price
VSTSKLT	7/8"	49"	1 7/8"	2	.1	\$315

Hutch Tackboard (Uses Guilford of Maine), for Cosmopolitan & Underground fabrics...add 25%*

Model#	Depth	Width	Height	Weight	Cube	Price
MM TKBD66	1"	66"	14 1/4"	19	1	\$498

MM TKBD66 fits 72" wide hutch.
For fabric color samples, see inside back cover.

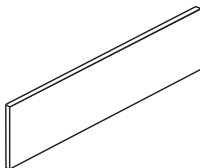

Fabric Chart

STANDARD FABRICS

Tempest 2120...Zebra 015, Silk 045 **Sprite 2671...**Snow 7040, Linen 7010 **Anchorage 2335...**Sunshine 2082, Waterfall 2691, Green Apple 2087, Aubergine 2036, Goose 2049, Onyx 2016, Red Delicious 2014
Metro 3077...Storefront 030, Skyscraper 022 **Cape Cod 3073...**Linen 7031, Surf 7062
Metalation 5118...Chrome 1676, Polished Pewter 1678 **Otto 2670...**Pebble 7012, Platinum 7010

25% UPCHARGE*

* **Cosmopolitan 3097...**Ivory 020, Cornsilk 021, Everglade 010, Shadow 060, Earthen 070
* **Underground 2967...**Champagne 010, Tangerine 070, Azure 050, Ocean 041, Pepper 030, Earth 061

Vista Series



Modesty Color Options



Standard TFL

VS MOD1 - Same as Chassis
VS MOD2 - Other Standard Color



Grayte Textured

VS MOD3



Pewter Brush

VS MOD4



Silver Matte

VS MOD5



Brushed Aluminum

VS MOD6



Aluminum Dots

VS MOD7

Metallic modesty upgrade for credenzas, bullet desks, reception and other pieces with arched modesty

VS UMOD_ (specify color from options) \$355

Example: To add a silver matte metallic modesty (VS MOD5) to a bullet desk, order VS UMOD5



Vista Series

Accessories

Specify handle option from below...No upcharge (Slight upcharge for H30, see below)

Crescent Handle, Metal - Black or Silver Finish



Model#	Hole Center	Width		Price
MM H3B	5"	5 3/4"	Black	N/C
MM H3S	5"	5 3/4"	Silver	N/C

Elliptical Handle, Metal - Black or Silver Finish



Model#	Hole Center	Width		Price
MM H5B	5"	6 3/4"	Black	N/C
MM H5S	5"	6 3/4"	Silver	N/C

Crescent Textured Nickel Handle, Metal - Silver Finish



Model#	Hole Center	Width		Price
MM H6	5"	6 1/4"		N/C

Flared Nickel Handle, Metal - Silver Finish



Model#	Hole Center	Width		Price
MM H7	5"	6 1/4"		N/C

Bow Handle, Silver Finish



Model#	Hole Center	Width		Price
MM H8	5"	6 1/8"		N/C

Curved Handle, Silver Finish



Model#	Hole Center	Width		Price
MM H9	5"	6 1/2"		N/C



Bar Handle, Silver Finish

Model#	Hole Center	Width		Price
MM H14	11"	14"		N/C
MM H30	27"	30"		\$56/ea.

30"W DO NOT fit on pedestal drawers or hutch doors.

Vista Series



Accessories

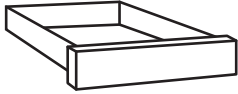

Center Drawer (9-ply birch wood drawer interior, specify front laminate color)

Model#	Depth	Width	Height	Weight	Cube	Price
MM CD	16"	21"	2 1/2"	12	.5	\$135

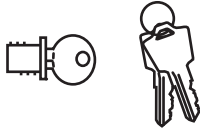

Face Lock (For center drawers, overhead & hinged doors, hutches)

Model#	Price
MM FL	\$71

One per set of two doors or drawers. Hutch with two or four doors takes two locks.
Glass doors do NOT lock.

3" Plastic

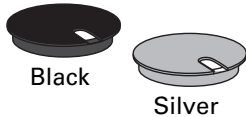

Grommet (Plastic cover, hole in surface, each) For Items Shown with Grommets

Model#	Depth	Width	Surface Hole Diameter	Price
MM GR234B Black Plastic	3"	3"	2 3/4"	\$45
MM GR234S Silver Plastic	3"	3"	2 3/4"	\$45

Specify grommet locations: Left, Right or Center. NO grommet over pedestals. See page 57 for grommet locations.

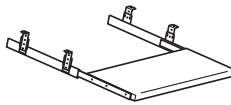

Keyboard Tray, Rollout (Specify laminate color)

Model#	Depth	Width	Height	Weight	Cube	Price
MM KB	16"	21"	3"	10	.5	\$124

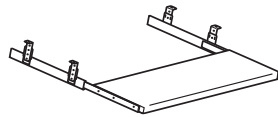

Oversize Keyboard Tray, Rollout (Specify laminate color)

Model#	Depth	Width	Height	Weight	Cube	Price
MM KBLG	16"	28"	3"	12	.5	\$181

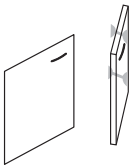

Optional Hinged Doors to Upgrade Flip-up Doors on Overheads (Two doors), choice of handles (specify)

Model#	Depth	Width	Height	Weight	Cube	Price
MM UPHD2	3/4"	varies	varies	varies	varies	\$175

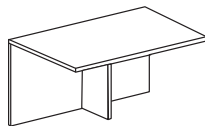

Support Panel with leveler ("Half-leg" - add to long pieces or to computer desk)

Model#	Depth	Width	Height	Weight	Cube	Price
MM SPT	12"	1"	28"	11	3	\$102

Support panel can also be used to create freestanding returns.

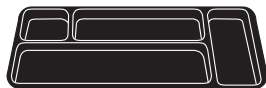

Box Drawer Convenience Tray (Insets to box drawer)

Model#	Depth	Width	Height	Weight	Cube	Price
MM BPT	5 1/2"	12"	1"	1	.5	\$27

Cartoning Charges

Model#	Price
MM CAR4 Pallet Cartoning	25%

(Corner & edge protectors w/bubble/shrink wrap, place in carton, strap to pallet)

Carton

Canyon Series

can • yon: (noun)

A deep area that affords an amazing view from the top to the bottom

Features

Canyon Series lends itself to the ultimate in style and craftsmanship. Innovative in design with its' unique carved banding edge detail. Use Canyon to accent the corner office or in open spaces to continue the innovative theme through the entire workspace.

Canyon is standard with full, locking pedestals and full modesty on desks, credenzas, bridges and returns. Many other features are standard on the Canyon Series.



Hutch Paper Sorter



Frosted Glass Modesty



Frosted Glass Doors on Hutch; Modesty on Desks



Grooved Edge



Glass Doors (Standard)

Canyon Series

TFM worksurface trimmed in 2mm detail matched to the worksurface. A beautiful, functional approach to office furniture that reminds one of true craftsmanship. A 72"-high profile for executive setups with two plinth base choices, multiple modesty selections on desks and tackboards for hutch. Quality, beauty and craftsmanship for all executive settings.

Product Specifications

Colors

- 18 standard colors are available in thermal-fused melamine
- All 18 standard colors are available on chassis

Tops/Worksurfaces

- 1" industrial quality (45 lb.) particleboard with TFM (Thermal-fused Melamine)
- Metal-to-metal connection fittings are installed for bridges and returns
- Wood grain direction on tops of bridges and returns run from user side to approach side to coordinate with main unit tops
- Tops have a "floating" appearance created by an inset "undertop" banded in a choice of silver or black

Chassis Construction

- TFM (Thermally Fused Melamine) chassis fastened by screws, steel brackets, and/or concealed fasteners
- Full pedestal is standard
- Full height modesty panel in framed glass is standard on desk only. Optional contrasting modesty or one of 5 metallic HPL modesties may be selected at no charge.
- Top edges are edged with 2 mm PVC edge banding
- Adjustable leveling glides on all units designed to set on the floor
- Hutches for Canyon Series are designed to fit Canyon Series ONLY and offer frosted glass doors and standard paper sorters and valance
- Product heights are coordinated to facilitate matching at 72 inches except 52" bookcase hutch
- Standard woodgrain direction on the modesty of desk and credenzas is vertical and on the backs of hutches and front of receptions is horizontal
- Plinth-base or square-feet are provided on all pedestals in choice of brushed aluminum laminate or black PVC banding

Drawer Suspension, Construction and Doors

- 9-ply Birch wood box and file drawers have full extension, progressive action slides with precision steel ball bearings
- Heavy-duty file rods in file drawers
- The full-overlay drawer fronts and doors are provided with choice of handles standard (except for hutch). If none are specified, H3 handles will be provided
- The TFM full-overlay doors on the hutch feature a recessed finger pull. Handles for optional glass hutch doors are not available

Cord Management

- Worksurface grommets are standard on bridges, returns and credenzas. Backs of hutches have standard rectangular grommets
- Grommets may be selected in black or silver color. The standard is to match the color of the trim on the undertop
- Optional power management is available.
- Cordgap exists below all modesty panels on worksurface units

Locks

- Standard on all pedestals.
- Black or silver, removable cores are standard for all locks
- Pedestal key numbers are randomly assigned to all locking pedestals, except that double pedestal units will be keyed alike
- Master keys and keyed-alike combinations are available

Configuration CY8R with
MOD10 modesty insert



Disclaimer: Dimensions assigned in this price list are nominal. If exact measurements are required, the requirement must be specified in the order and specifically acknowledged by Maverick. Maverick reserves the right to change construction details and standards without notification, if necessary.

Canyon Series

How to Order Canyon Series

WORKSURFACE UNITS: DESKS, CREDENZAS AND RETURNS

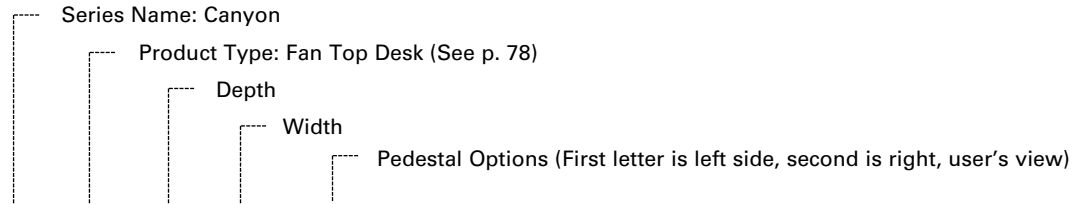

1. Product number: **CY DF 36 72 BB**
2. Specify worksurface finish
3. Specify Undertop Trim Color - silver or black.
4. Specify Chassis Finish. Matching color edge banding is standard.
5. Specify Plinth Base or Square Feet.
6. Specify Plinth Base or Square Feet color - silver or black. Standard is matching undertop trim color.
7. Specify modesty color - standard on 72" w desk is CY MOD10 glass modesty unless otherwise specified. No-charge for options, CY MOD1 through CY MOD7 (see page 138).
8. Specify handle option. Choice of handle is standard. MM H3B is the default handle if none is specified. See below and page 136. NOTE: No handles are available for hutch (15") glass doors.
9. Specify Grommet Color - Silver-color or black plastic cap. Standard is matching undertop color.

HANDLE UPGRADE OPTIONS:

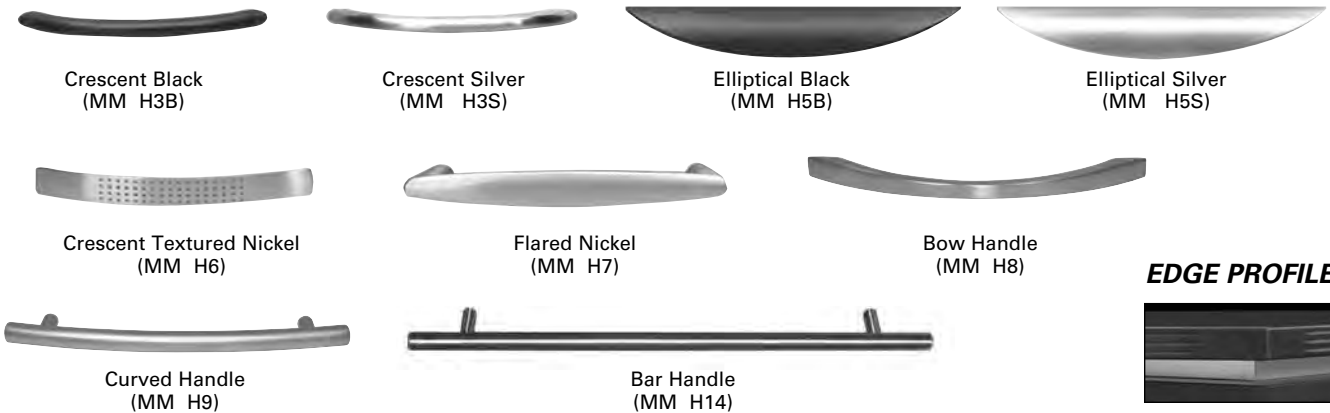

EDGE PROFILE:

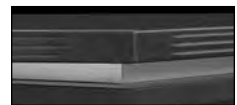

SIDE VIEW:

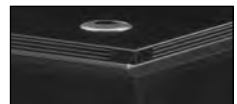

IMPORTANT NOTE: Choice of handles H3 - H9 is standard on all drawers and doors except hutches. No handles are available for hutch (15") glass doors.

PEDESTAL/BASE OPTIONS:

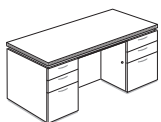

Full Pedestal
box/box/file (B)

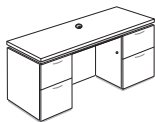

Full Pedestal
file/file (F)



Lateral File
lateral file (L)



HUTCH GROMMET



TOP GROMMET

Canyon Series

Statement of Line

DESKS:

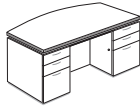

Desk Fan Top - dbl. ped.
(CYDF___BB)

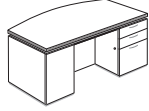

Desk Fan Top - sgl. ped.
(CYDF___XB)

BRIDGE:

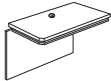

Return - bridge
(CYBR___)

RETURNS:

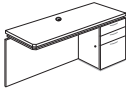

Return - box/box/file
(CYR___BX)

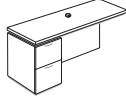

Return - file/file
(CYR___FX)

CREDENZAS:

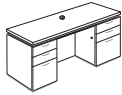

Credenza - dbl. ped. box/box/file
(CYCE___BB)



Credenza - dbl. ped. file/file, box/box/file
(CYCE___FB)



Credenza - dbl. ped. file/file
(CYCE___FF)



Credenza - single ped. box/box/file
(CYCE___BX)



Credenza - single ped. file/file
(CYCE___FX)



Credenza - lateral file
(CYCE___XL)

CREDENZAS:

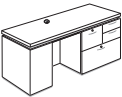

Credenza - personal lateral file
(CYCE___PLXF)

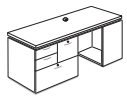

Credenza - personal lateral file
(CYCE___PLFX)

HUTCHES:

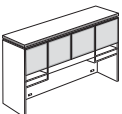

Hutch - with doors
(CYHD)

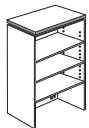

Hutch - bookcase
(CYHB)

STORAGE:



Storage - cabinet
(CYHDC)

BOOKCASES:



Bookcase
(CYBC)

FILING:



Lateral File

RECEPTION:

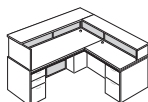

Reception
(CYRCAL___L)

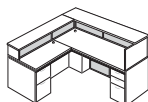

Reception
(CYRCAL___R)

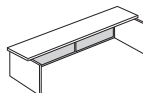

Reception
(CYRB)

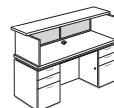

Reception
(CYCDE)

Canyon Series

Configurations

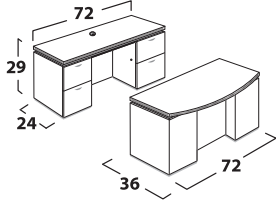

CY1

1	CYDF3672BB	\$2,150
1	CYCE2472FF	\$1,661
		\$3,811

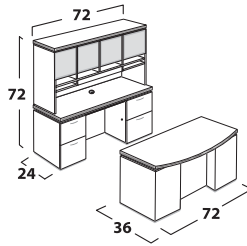

CY2

1	CYDF3672BB	\$2,150
1	CYCE2472FF	\$1,661
1	CYHD1672	\$1,804
		\$5,615

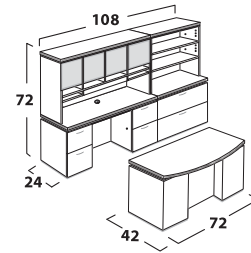

CY3

1	CYDF4272BB	\$2,240
1	CYCE2472FF	\$1,661
1	CYHD1672	\$1,804
1	CYL22436L	\$1,089
1	CYHB1542	\$666
		\$7,460

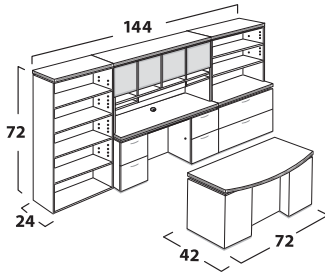

CY4

1	CYDF4272BB	\$2,240
1	CYCE2472FF	\$1,661
1	CYBC1572	\$1,027
1	CYHD1672	\$1,804
1	CYL22436L	\$1,089
1	CYHB1542	\$666
		\$8,487

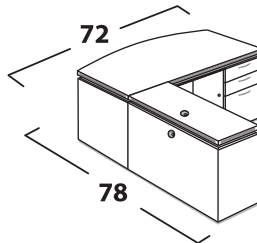

CY5L

1	CYDF3672XB	\$1,866
1	CYRL2442BX	\$1,091
		\$2,957

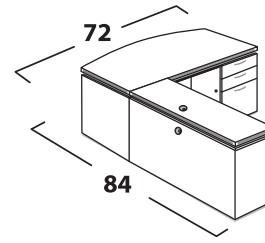

CY6L

1	CYDF3672XB	\$1,866
1	CYRL2448BX	\$1,102
		\$2,968

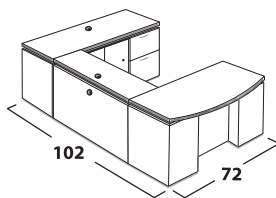

CY7R

1	CYDF3672BX	\$1,866
1	CYBR2442	\$404
1	CYCE2472XF	\$1,331
		\$3,601

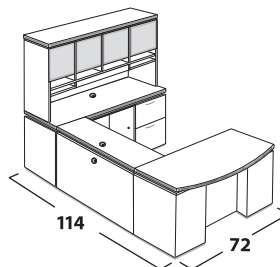

CY8R

1	CYDF3672BX	\$1,866
1	CYBR2454	\$473
1	CYHD1672	\$1,804
1	CYCE2472XL	\$1,618
		\$5,761

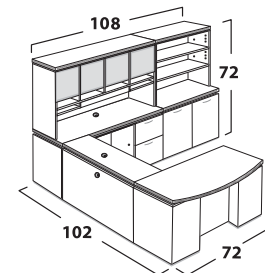

CY9R

1	CYDF3672BX	\$1,866
1	CYBR2442	\$404
1	CYCE2472XF	\$1,331
1	CYHD1672	\$1,804
1	CYHDC2436	\$760
1	CYHB1542	\$666
		\$6,831

Canyon Series

Desks

* Standard Glass Modesty Panel on 72"W desk units only, unless specified "No Glass Modesty"

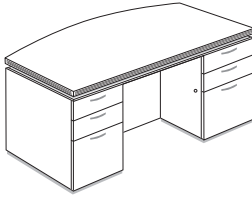

Desk, Fan Top Double Pedestal, Box/Box/File Left and Right (Locking pedestals, choice of handles)

Model#	Depth	Width	Height	Weight	Cube	Price
CYDF3672BB	30/36"	72"	29"	318	45	\$2,150
CYDF4272BB	36/42"	72"	29"	385	52	\$2,240

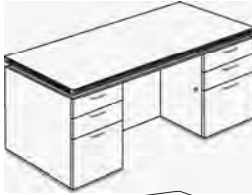

Desk, Rectangular Double Pedestal, Box/Box/File Left and Right (Locking pedestals, choice of handles)

Model#	Depth	Width	Height	Weight	Cube	Price
CYDE3066BB	30"	66"	29"	270	32	\$1,692
CYDE3672BB	36"	72"	29"	318	40	\$2,234

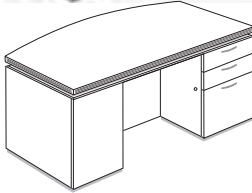

Desk, Fan Top Single Pedestal, Box/Box/File Right (Locking pedestal, choice of handles)

Model#	Depth	Width	Height	Weight	Cube	Price
CYDF3672XB	30/36"	72"	29"	284	45	\$1,866
CYDF4272XB	36/42"	72"	29"	380	52	\$1,991

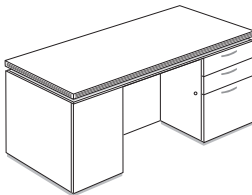

Desk, Single Pedestal, Box/Box/File Right (Locking pedestal, choice of handles)

Model#	Depth	Width	Height	Weight	Cube	Price
CYDE3066XB	30"	66"	29"	270	40	\$1,432
CYDE3072XB	30"	72"	29"	280	45	\$1,835
CYDE3672XB	36"	72"	29"	295	52	\$1,960

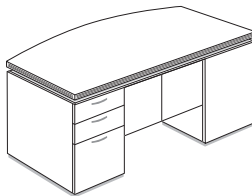

Desk, Fan Top Single Pedestal, Box/Box/File Left (Locking pedestal, choice of handles)

Model#	Depth	Width	Height	Weight	Cube	Price
CYDF3672BX	30/36"	72"	29"	284	45	\$1,866
CYDF4272BX	36/42"	72"	29"	380	52	\$1,991

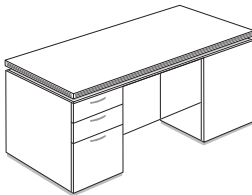

Desk, Single Pedestal, Box/Box/File Left (Locking pedestal, choice of handles)

Model#	Depth	Width	Height	Weight	Cube	Price
CYDE3066BX	30"	66"	29"	270	40	\$1,432
CYDE3072BX	30"	72"	29"	280	45	\$1,835
CYDE3672BX	36"	72"	29"	295	52	\$1,960

Bridges

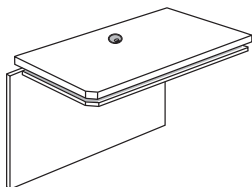

Bridge Section, Component (Full modesty panel, grommet)

Model#	Depth	Width	Height	Weight	Cube	Price
CYBR2442	24"	42"	29"	76	18	\$404
CYBR2448	24"	48"	29"	88	20	\$435
CYBR2454	24"	54"	29"	100	24	\$473

Standard grommet top and modesty panel.

Canyon Series

Returns

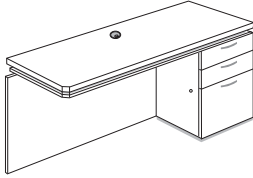

Return, Box/Box/File Pedestal Right (Full modesty, locking pedestal, handles, grommets)

Model#	Depth	Width	Height	Weight	Cube	Price
CYRR2442XB	24"	42"	29"	143	18	\$1,091
CYRR2448XB	24"	48"	29"	156	20	\$1,102

Standard grommet top and modesty panel.

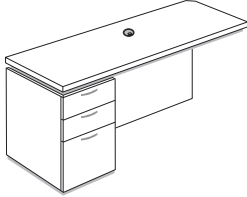

Return, Box/Box/File Pedestal Left (Full modesty, locking pedestal, handles, grommets)

Model#	Depth	Width	Height	Weight	Cube	Price
CYRL2442BX	24"	42"	29"	143	18	\$1,091
CYRL2448BX	24"	48"	29"	156	20	\$1,102

Standard grommet top and modesty panel.

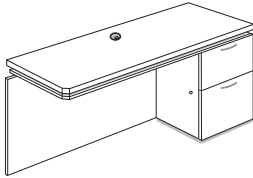

Return, File/File Pedestal Right (Full modesty, locking pedestal, handles, grommets)

Model#	Depth	Width	Height	Weight	Cube	Price
CYRR2442XF	24"	42"	29"	143	18	\$1,037
CYRR2448XF	24"	48"	29"	156	20	\$1,065

Standard grommet top and modesty panel.

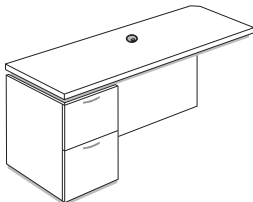

Return, File/File Pedestal Left (Full modesty, locking pedestal, handles, grommets)

Model#	Depth	Width	Height	Weight	Cube	Price
CYRL2442FX	24"	42"	29"	143	18	\$1,037
CYRL2448FX	24"	48"	29"	156	20	\$1,065

Standard grommet top and modesty panel.

Credenzas

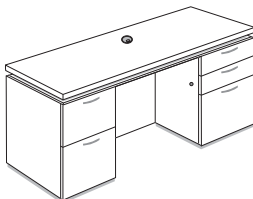

Credenza, Double Pedestal, File/File on Left, Box/Box/File on Right

Model#	Depth	Width	Height	Weight	Cube	Price
CYCE2472FB	24"	72"	29"	251	30	\$1,661

Standard grommet top and modesty panel.

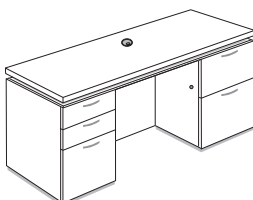

Credenza, Double Pedestal, Box/Box/File on Left, File/File on Right

Model#	Depth	Width	Height	Weight	Cube	Price
CYCE2472BF	24"	72"	29"	251	30	\$1,661

Standard grommet top and modesty panel.

Canyon Series

Credenzas

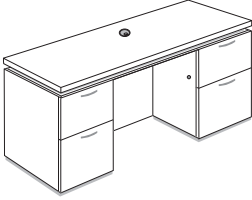

Credenza, Double Pedestal, File/File on Left and Right

Model#	Depth	Width	Height	Weight	Cube	Price
CYCE2472FF	24"	72"	29"	251	30	\$1,661

Standard grommet top and modesty panel.

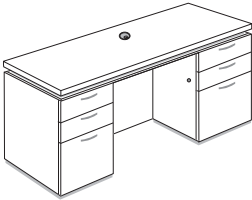

Credenza, Double Pedestal, Box/Box/File on Left and Right

Model#	Depth	Width	Height	Weight	Cube	Price
CYCE2472BB	24"	72"	29"	251	30	\$1,661

Standard grommet top and modesty panel.

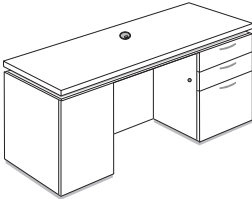

Credenza, Single Pedestal, Box/Box/File on Right

Model#	Depth	Width	Height	Weight	Cube	Price
CYCE2472XB	24"	72"	29"	221	30	\$1,331

Standard grommet top and modesty panel.

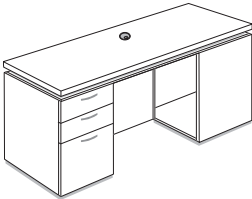

Credenza, Single Pedestal, Box/Box/File on Left

Model#	Depth	Width	Height	Weight	Cube	Price
CYCE2472BX	24"	72"	29"	221	30	\$1,331

Standard grommet top and modesty panel.

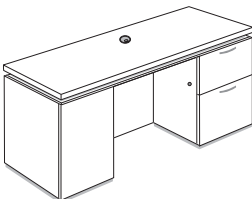

Credenza, Single Pedestal, File/File on Right

Model#	Depth	Width	Height	Weight	Cube	Price
CYCE2472XF	24"	72"	29"	221	30	\$1,331

Standard grommet top and modesty panel.

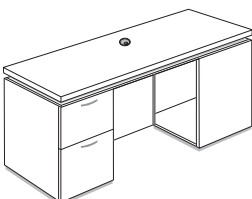

Credenza, Single Pedestal, File/File on Left

Model#	Depth	Width	Height	Weight	Cube	Price
CYCE2472FX	24"	72"	29"	221	30	\$1,331

Standard grommet top and modesty panel.

Canyon Series

Credenzas

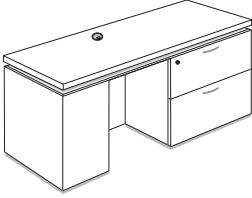

Credenza, Single Pedestal, Lateral File on Right

Model#	Depth	Width	Height	Weight	Cube	Price
CYCE2472XL	24"	72"	29"	284	30	\$1,618

For H30 handle, add \$52 each. Standard grommet top and modesty panel.

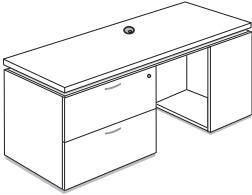

Credenza, Single Pedestal, Lateral File on Left

Model#	Depth	Width	Height	Weight	Cube	Price
CYCE2472LX	24"	72"	29"	284	30	\$1,618

For H30 handle, add \$52 each. Standard grommet top and modesty panel.

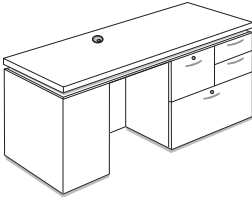

Credenza, Single Pedestal, Personal Lateral File on Right

Model#	Depth	Width	Height	Weight	Cube	Price
CYCE2472PLXF	24"	72"	29"	284	30	\$1,804

Standard grommet top and modesty panel.

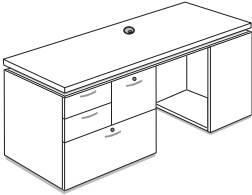

Credenza, Single Pedestal, Personal Lateral File on Left

Model#	Depth	Width	Height	Weight	Cube	Price
CYCE2472PLFX	24"	72"	29"	284	30	\$1,804

Standard grommet top and modesty panel.

Filing

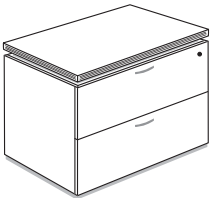

Lateral File (Lock standard on user's right)

Model#	Depth	Width	Height	Weight	Cube	Price
CYL22436L	24"	36"	29"	192	15	\$1,089

For H30 handle, add \$56 each.

Canyon Series

Hutches

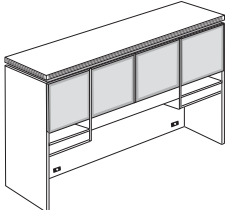

Hutch With Glass Doors (19" clearance below fascia/valance, left and right mail sorter)

Model#	Depth	Width	Height	Weight	Cube	Price
CYHD1672	16"	72"	42"	237	28	\$1,804

Note: No handles or locks are available for glass doors. For tasklight, add CYTSKLT...\$175.
For tackboard, add MM TKBD66...\$498, see page 137.

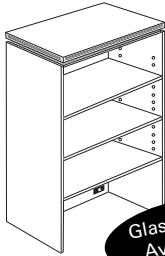

Glass Doors Available

Hutch, Bookcase (1" -thick shelves)

Model#	Depth	Width	Height	Weight	Cube	Price
CYHB1542	15/16"	36"	42"	117	14	\$668
CYHB1552	15/16"	36"	52"	143	17	\$727

Note: Only the 52"-high unit may be ordered with optional glass doors and has one fixed and two adjustable shelves, see below. 42"-high unit has one adjustable shelf, one fixed shelf and two rectangular grommets. On both 42" and 52" units the top front overhangs leg front by 1".

Door Options

CY WD52

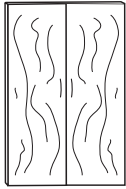

CY VW52

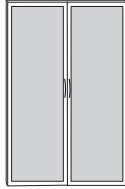

Bookcase Hutch Doors, Pair (Solid TFM in choice of colors; Frosted glass with silver vinyl-wrapped MDF frame, select handles)

Model#	Depth	Width	Height	Weight	Cube	Price
CY WD52	3/4"	36"	53"	30	1	\$388
CY VW52	3/4"	36"	53"	28	1	\$1,094

Designed to fit CYHB1552.

Choose handles from H3, H5, H6, H7, H8, H9, and H14 only...see page 136.

Storage

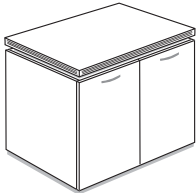

Utility Cabinet with Matching Color TFM Wood Doors (One 3/4" adjustable shelf)

Model#	Depth	Width	Height	Weight	Cube	Price
CYHDC2436	24"	36"	29"	175	15	\$760

Note: Optional face lock available, add MM FL...\$71 each. Wood doors only, glass doors are not available.

Bookcases

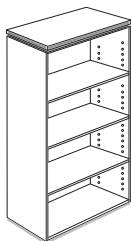

Bookcases (1" -thick shelves, plinth base)

Model#	Shelves	Depth	Width	Height	Weight	Cube	Price
CYBC1530	1	15"	36"	30"	108	10	\$591
CYBC1548	2	15"	36"	48"	150	15	\$716
CYBC1560	3	15"	36"	60"	182	19	\$871
CYBC1572	4	15"	36"	72"	214	23	\$1,027

See available accessories and upgrades, pp. 136-138.

Canyon Series

Reception

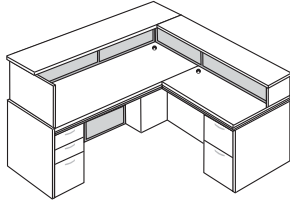

Reception "L" Unit, Right Return 24" x 48" Inset Front (Desk counter only)

Model#	Depth	Width	Height	Weight	Cube	Price
CYDER3672BX	36"	72"	29"	295	52	\$2,114
CYRRR2448XF	24"	48"	29"	156	20	\$1,207
CYRB7284R	12"	72/84"	14"	140	3	\$1,442

Note: Desk has Box/Box/File pedestal, return is 24" x 48" and has File/File pedestal.
Standard glass modesty panel on 72"W desk units only, unless specified "No Glass Modesty".
Specify modesty option from page 138, CY MOD1 through CY MOD7.

Desk and return is designed to accept reception counter.

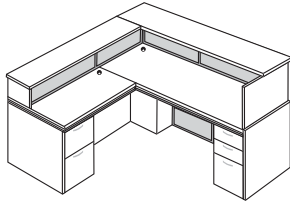

Reception "L" Unit, Left Return 24" x 48" Inset Front (Desk counter only)

Model#	Depth	Width	Height	Weight	Cube	Price
CYDER3672XB	36"	72"	29"	295	52	\$2,114
CYRRL2448FX	24"	48"	29"	156	20	\$1,207
CYRB7284L	12"	72/84"	14"	140	3	\$1,442

Note: Desk has Box/Box/File pedestal, return is 24" x 48" and has File/File pedestal.
Standard glass modesty panel on 72"W desk units only, unless specified "No Glass Modesty".
Specify modesty option from page 138, CY MOD1 through CY MOD7.

Desk and return is designed to accept reception counter.

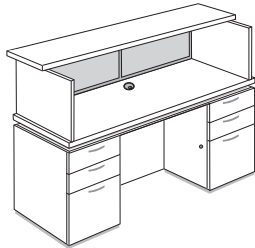

Reception, Double Pedestal Desk, 36" x 72" Inset Front (Desk counter only)

Model#	Depth	Width	Height	Weight	Cube	Price
CYDER3672BB	36"	72"	29"	390	65	\$2,390
CYRB72	36"	72"	14"	70	21	\$937

Note: Desk has Box/Box/File each pedestal. Standard glass modesty panel on 72"W desk units only, unless specified "No Glass Modesty". Specify modesty option from page 138 CYMOD1-CYMOD7.

Desks designed to accept reception counter.

For single pedestal desk choose CYDER3672BX or XB (see above).

NOTE: Standard grommet locations as shown.

Black or Silver will match under top trim and base.

Canyon Series

Accessories

Specify handle option from below...No upcharge (Slight upcharge for H30, see below)



Crescent Handle, Metal - Black or Silver Finish

Model#	Hole Center	Width		Price
MM H3B	5"	5 3/4"	Black	N/C
MM H3S	5"	5 3/4"	Silver	N/C



Elliptical Handle, Metal - Black or Silver Finish

Model#	Hole Center	Width		Price
MM H5B	5"	6 3/4"	Black	N/C
MM H5S	5"	6 3/4"	Silver	N/C



Crescent Textured Nickel Handle, Metal - Silver Finish

Model#	Hole Center	Width		Price
MM H6	5"	6 1/4"		N/C



Flared Nickel Handle, Metal - Silver Finish

Model#	Hole Center	Width		Price
MM H7	5"	6 1/4"		N/C



Bow Handle, Silver Finish

Model#	Hole Center	Width		Price
MM H8	5"	6 1/8"		N/C



Curved Handle, Silver Finish

Model#	Hole Center	Width		Price
MM H9	5"	6 1/2"		N/C



Bar Handle, Silver Finish

Model#	Hole Center	Width		Price
MM H14	11"	14"		N/C
MM H30	27"	30"		\$56/ea.

30" DO NOT fit on pedestal drawers or hutch doors.

Canyon Series

Accessories and Upgrades

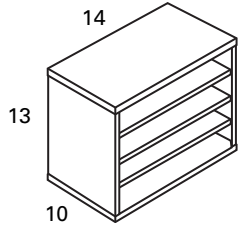

Paper Manager Mail Sorter (Three adjustable shelves, set-on-surface, flat PVC edges)

Model#	Depth	Width	Height	Weight	Cube	Price
CY MS121414	10"	14"	13"	10	1.4	\$149



Tasklight (Black, One Light Only) with grommet on hutch back

Model#	Depth	Width	Height	Weight	Cube	Price
CYTSKLT	7/8"	49"	1 7/8"	2	.1	\$175

3" Plastic

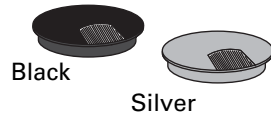

Grommet (Plastic cover, hole in surface, each)

Model#		Depth	Width	Surface Hole Diameter	Price
NA GR3B	Black Plastic w/brush	3 1/2"	3 1/2"	3"	\$71
NA GR3S	Silver Plastic w/brush	3 1/2"	3 1/2"	3"	\$71

Specify grommet location...Left, Right or Center. No grommets over pedestals.

Hutch Tackboard (Uses Guilford of Maine), for Cosmopolitan & Underground fabrics...add 25%*

Model#	Depth	Width	Height	Weight	Cube	Price
MM TKBD66	1"	66"	14 1/4"	19	1	\$498

MM TKBD66 fits 72" wide hutch.
For fabric color samples, see inside back cover.

Fabric Chart

STANDARD FABRICS

Tempest 2120...Zebra 015, Silk 045 **Sprite 2671...**Snow 7040, Linen 7010 **Anchorage 2335...**Sunshine 2082, Waterfall 2691, Green Apple 2087, Aubergine 2036, Goose 2049, Onyx 2016, Red Delicious 2014

Metro 3077...Storefront 030, Skyscraper 022 **Cape Cod 3073...**Linen 7031, Surf 7062

Metallation 5118...Chrome 1676, Polished Pewter 1678 **Otto 2670...**Pebble 7012, Platinum 7010

25% UPCHARGE*

* **Cosmopolitan 3097...**Ivory 020, Cornsilk 021, Everglade 010, Shadow 060, Earthen 070

* **Underground 2967...**Champagne 010, Tangerine 070, Azure 050, Ocean 041, Pepper 030, Earth 061

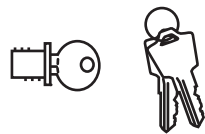

Face Lock (For hinged doors, storage)

Model#	Price
MM FL	\$71

Cartoning Charges

Model#	Price
MM CAR4 Pallet Cartoning (Corner & edge protectors w/bubble/shrink wrap, place in carton, strap to pallet)	25%

Carton

Canyon Series

Desk Modesty Color Options



Standard TFL

CY MOD1 - Same as Chassis
CY MOD2 - Other Standard Color



Grayte Textured

CY MOD3



Pewter Brush

CY MOD4



Silver Matte

CY MOD5



Brushed Aluminum

CY MOD6



Aluminum Dots

CY MOD7

Desk Modesty Glass-look Option (Standard for 72" w Desk Only. N/A for other widths)



Desk Framed
Glass Modesty

Silver-wrapped Frame with Frosted Glass

CY MOD10



Conference Collection

Edge Banded

Edge Detail

Maverick Series

1 3/4"-high built-up edge of thermally-fused melamine laminate with 2mm-thick PVC edge banding. Corners are radiused. Round tables are 1" thick.

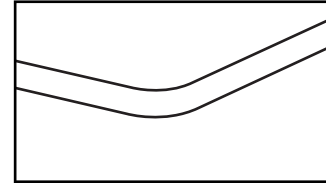

Arroyo Series

1"-high built-up edge of thermally-fused melamine laminate with 2mm-thick PVC edge banding. Round tables are 1" thick.

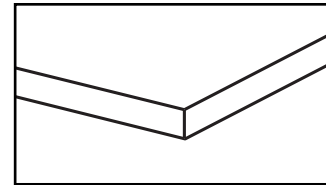

Conference Collection



The Conference Collection presents conference table selections in all series. Details of the table tops is provided for each series below, and on the facing page. Specifications are found in each of the applicable series.

Product Specifications

Colors

- All 18 standard colors are available for edge banded series. See back cover

TOPS

MAVERICK

- 2mm PVC edge banding
- 1 3/4"-thick thermally fused melamine (TFM) built-up top
- Rectangular and Boatshape tables feature contoured (rounded) corners
- Round tables are 1" TFM

ARROYO

- 2mm PVC edge banding
- 1"-thick thermally fused melamine (TFM)
- Rectangular and Boatshape tables feature Angular corners
- Round tables are 1" TFM

LEGS AND BASES

- See wide range of options on pages 144-146
- Attachment of legs to tops is either by metal-to-metal connection or by use of "L" brackets and wood screws

OTHER

Note: Dimensions assigned in this price list are nominal. If exact measurements are required, the requirement must be specified in the order and specifically acknowledged by Maverick. Maverick reserves the right to change construction details and standards without notification, if necessary.

Statement of Line

CONFERENCE:



Conference - Boatshape (Maverick)
(MM BS)



Conference - Racetrack (All)
(RT)



Conference - Arched Valance (Maverick)
(AV)



Conference - Rectangular (Maverick)
(MM RE)



Conference - Round (All)
(RD)

CONFERENCE:



Conference - Boatshape All Others
(BS)

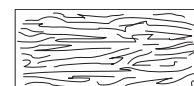

Conference - Rectangular All Others
(RE)



Conference Collection

How to Order Conference Collection - Tables

WORKSURFACE UNITS:

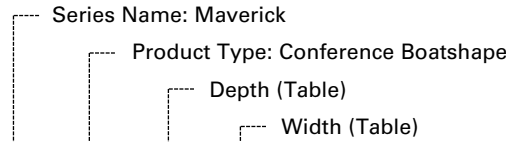

1. Product number: **MM BS 42 96**
2. Specify worksurface finish. See back cover.
3. Specify worksurface edge trim finish. Matching color is standard. See back cover.
4. Specify base. See page 144-146 for options and prices. Ordered separately

NOTE: Prices for tops do not include prices for base(s).
Some lengths require three bases for tables. Edge detail varies by series.

CORNER SHAPE:

Maverick Series



Arroyo Series



HANDLE OPTIONS FOR CONFERENCE CASEGOODS:

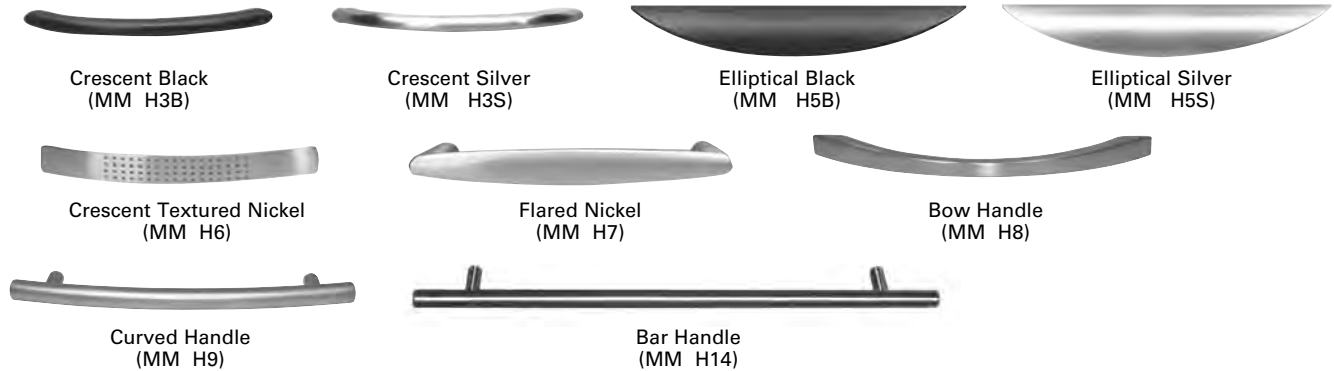

BASE OPTIONS:

See pages 144-146 for all options

Leg Style	Table Size	(36" D)	(42" D)	(>48" D)
MM LEG A)	Square Panel Legs (ea.)	20"=\$129	24"=\$129	24"=\$129
MM LEG B)	Radius Panel Legs (ea.)	20"=\$232	24"=\$232	24"=\$232
MM LEG C)	Cylinder Base (ea.)	20"=\$465	24"=\$540	30"=\$630
MM LEG D)	Half-Cylinder Base (ea.)	20"=\$425	24"=\$500	30"=\$589
MM LEG E)	Crescent Base (ea.)	20"=\$453	24"=\$528	30"=\$603
MM LEG F)	Flat Panel X Base (ea.)	20"=\$207	24"=\$232	24"=\$232
MM LEG G)	Sculpted Panel X Base (ea.)	20"=\$266	24"=\$293	24"=\$293
MM LEG I)	Metal Four Star Base (ea.)	30"=\$246	30"=\$246	36"=\$288
MM LEG JB)	Black Metal 4" Column Leg (ea.)	4"= \$116	4"= \$116	4"= \$116
MM LEG JS)	Silver Metal 4" Column Leg (ea.)	4"= \$143	4"= \$143	4"= \$143
MM LEG LB)	Black Metal 2" Column Leg (ea.)	2"= \$39	2"= \$39	2"= \$39
MM LEG LS)	Silver Metal 2" Column Leg (ea.)	2"= \$55	2"= \$55	2"= \$55
MM LEG ASQWD)	Square Panel Base w/Door (ea.)	24"=\$873	24"=\$873	24"=\$873
MM LEG ASQND)	Square Panel Base (No access door) (ea.)	24"=\$518	24"=\$518	24"=\$518
MM LEG D24WD)	Half-Cylinder w/Door (ea.)	24"=\$834	24"=\$834	24"=\$834
MM LEG M)	Square Panel Base w/End Door (ea.)	20"=\$354	24"=\$373	24"=\$373

NOTE: Column legs JS/JB and LS/LB are for bullet desk usage purposes only.

Conference Collection

The Maverick Solution for the Conference Room

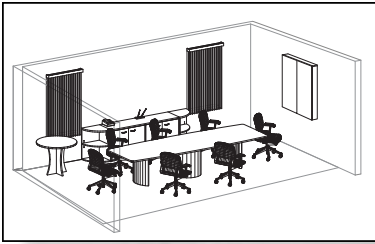

Choosing the Right Table - The Maverick Solution

► Select your function/size

Round Tables = For smaller, more informal spaces and fewer people:

36" for 3 seats, 42" for 4 seats, 48" for 5 seats, 54" for 6 seats

Rectangular, Boat-shape, Racetrack or Arched Valance = For larger spaces and more seats:

72" or 84" for 6 seats; 96", 108", 120" for 8 seats; 144" for 12 seats

► Select your style

Table Shape = Round, Rectangular, Boat-shape, Racetrack or Arched Valance

Table Style = Edge banded

Table Color = From 16 standard colors - mix or match, including edge trim color

Base Style = Panel, cylinder, crescent, etc., see pages 144-146

Base Color = Select from 16 standard colors



Conference Collection

CONFERENCE TABLES

QuickShip with Leg A only. Tables with a width of 144" are made in two pieces.

PRICES ARE FOR TOPS ONLY

SERIES (SPECIFY)	MODEL #					
	BASES	DEPTH	WIDTH	HEIGHT	WEIGHT	CUBE

LIST PRICE BY SERIES					
MM (Maverick)	AR (ARROYO)				

Boatshape Conference Table (Modesty)



Maverick Series



All Other Series

BS3672	2	36"	72"	*	185	9	\$530	\$427				
BS4284	2	42"	84"	*	250	10	\$609	\$505				
BS4296	2	42"	96"	*	310	12	\$686	\$569				
BS42120	3	42"	120"	*	335	15	\$853	N/A				
BS42144	3	42"	144"	*	360	18	\$1,410	N/A				
BS48120	3	48"	120"	*	335	17	\$1,023	N/A				
BS48144	3	48"	144"	*	360	19	\$1,488	N/A				

Racetrack Conference Table (modesty)

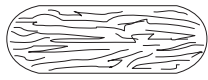

All Series

RT3672	2	36"	72"	*	185	9	\$621	\$441				
RT4284	2	42"	84"	*	250	10	\$723	\$518				
RT4296	2	42"	96"	*	310	12	\$803	\$583				
RT42120	3	42"	120"	*	335	15	\$919	N/A				
RT42144	3	42"	144"	*	360	18	\$1,553	N/A				
RT48120	3	48"	120"	*	335	17	\$1,099	N/A				
RT48144	3	48"	144"	*	360	19	\$1,682	N/A				

Rectangular Conference Table (modesty)



Maverick Series

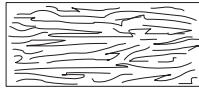

All Other Series

RE3672	2	36"	72"	*	185	9	\$505	\$376				
RE4284	2	42"	84"	*	215	10	\$530	\$454				
RE4296	2	42"	96"	*	250	14	\$635	\$519				
RE42120	3	42"	120"	*	310	15	\$829	N/A				
RE42144	3	42"	144"	*	355	18	\$1,327	N/A				
RE48120	3	48"	120"	*	335	18	\$1,023	N/A				
RE48144	3	48"	144"	*	400	19	\$1,424	N/A				

Round Table



All Series

RD36		36"	36"	*	75	6	\$363	N/A				
RD42		42"	42"	*	85	7	\$441	N/A				
RD48		48"	48"	*	100	8	\$556	N/A				
RD54		54"	54"	*	115	10	\$635	N/A				

Arched Valance Rectangular Conference Table (modesty)



Maverick Series

SQ36		36"	36"	*	75	6	\$336	N/A				
SQ42		42"	42"	*	85	7	\$441	N/A				
SQ48		48"	48"	*	100	8	\$556	N/A				
SQ54		54"	54"	*	115	10	\$635	N/A				



Tops width from 72" – 120" are standard 1-Piece Top
 *MAVERICK SERIES 120"W TOPS:
 Add MMCUT2 \$142 List to cut 120" w top into 2-piece top



Tops width 144" are standard 2-Piece Top

- Maverick conference table tops (boatshape, racetrack, rectangular) are 1 3/4" thick (built-up edges)
- Maverick conference table tops (round and square) are 1" thick

REMINDER: Prices are TOPS ONLY - Order legs/bases separately.

Conference Collection



NOTE: Prices are available ONLY with purchase of a top. In general, an up-charge of 20% will apply to legs when no top is ordered.





Square Panel Leg (20" leg for 36" tables, 24" leg for 42" deep & 48" deep)

Model#	Depth	Width	Height	Price
 AR LEG A20	1"	20"	28"	\$60/ea.
 AR LEG A24	1"	24"	28"	\$60/ea.
AR LEG A30	1"	30"	28"	\$182/ea.

For Arroyo Conference Table Tops.



Square Panel Leg (20" leg for 36" tables, 24" leg for ≥ 42" deep & 48" deep)

Model#	Depth	Width	Height	Price
 MM LEG A20	1 3/4"	20"	28"	\$129/ea.
 MM LEG A24	1 3/4"	24"	28"	\$129/ea.
MM LEG A30	1 3/4"	30"	28"	\$182/ea.

Stretcher bars 1"x7"H are standard with square panel legs.
Add MMCUT1...\$85 for each leg when ordering power management.



Radius Panel Leg (20" leg for 36" tables, 24" leg for 42" deep & 48" Top)

Model#	Depth	Width	Height	Price
MM LEG B20	1 3/4"	20"	28"	\$232/ea.
MM LEG B24	1 3/4"	24"	28"	\$232/ea.
MM LEG B30	1 3/4"	30"	28"	\$373/ea.

Stretcher bars 1"x7"H are standard with square panel legs.
Add MMCUT1...\$85 for each leg when ordering power management.

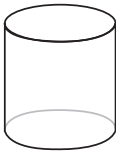

Cylinder Base (20" for 36"D Top, 24" for 42", 48"D Top, 30" for 54" Top)

Model#	Depth	Width	Height	Price
MM LEG C20	20"	20"	28"	\$465/ea.
MM LEG C24	24"	24"	28"	\$540/ea.
MM LEG C30	30"	30"	28"	\$630/ea.



Half-Cylinder Base (20" for 36"D Top, 24" for 42", 48"D Top, 30" for 54" Top)

Model#	Depth	Width	Height	Price
MM LEG D20	10"	20"	28"	\$425/ea.
MM LEG D24	12"	24"	28"	\$500/ea.
MM LEG D30	15"	30"	28"	\$589/ea.



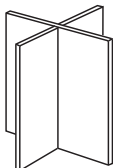

Crescent Base (20" for 36"D Top, 24" for 42", 48"D Top, 30" for 54" Top)

Model#	Depth	Width	Height	Price
MM LEG E20	10"	20"	28"	\$453/ea.
MM LEG E24	12"	24"	28"	\$528/ea.
MM LEG E30	15"	30"	28"	\$603/ea.



Flat Panel X-Base (20" leg for 36" tables, 24" leg for 42" deep & 48" Top)

Model#	Depth	Width	Height	Price
 MM LEG F20	20"	20"	28"	\$207/ea.
 MM LEG F24	24"	24"	28"	\$232/ea.





Conference Collection

Bases





Sculptured Panel X-Base (20" leg for 36" top, 24" leg for > 42" & 48" top)

Model#	Depth	Width	Height	Price
 MM LEG G20	20"	20"	28"	\$266
 MM LEG G24	24"	24"	28"	\$293



Metal Four-Star Base, Black (30" Base for 36" top, 36" Base for 42", 48" \$ 54" top)

Model#	Depth	Width	Height	Price
 MM LEG I30B	30"	30"	28"	\$246
 MM LEG I36B	36"	36"	28"	\$288



Metal Four-Star Base, Chrome (30" Base for 36" top, 36" Base for 42", 48" \$ 54" top)

Model#	Depth	Width	Height	Price
MM LEG I30C	30"	30"	28"	\$522
MM LEG I36C	36"	36"	28"	\$675



Metal Four-Star Base, Silver Powder Coat (30" Base for 36" top, 36" Base for 42", 48" \$ 54" top)

Model#	Depth	Width	Height	Price
MM LEG I30S	30"	30"	28"	\$327
MM LEG I36S	36"	36"	28"	\$428



Bar Height Metal Four Star Base, Black (30" Base for 36" top, 36" Base for 42", 48" \$ 54" top)

Model#	Depth	Width	Height	Price
MM LEGIBH30B	30"	30"	41"	\$321
MM LEGIBH36B	30"	36"	41"	\$423



Bar Height Metal Four Star Base, Chrome (30" Base for 36" top, 36" Base for 42", 48" \$ 54" top)

Model#	Depth	Width	Height	Price
MM LEGIBH30C	30"	30"	41"	\$670
MM LEGIBH36C	30"	36"	41"	\$843



Bar Height Metal Four Star Base, Silver Powder Coat (30" Base for 36" top, 36" Base for 42", 48" \$ 54" top)

Model#	Depth	Width	Height	Price
MM LEGIBH30S	30"	30"	41"	\$439
MM LEGIBH36S	30"	36"	41"	\$530

Conference Collection



Bases



Square Panel Leg with Plinth Base, No Door (24" Base for 42"D/48"D tables, 30" Base for 54" deep & up)

Model#	Depth	Width	Height	Price
MM LEG ASQND1224	12"	24"	28"	\$518
MM LEG ASQND1230	12"	30"	28"	\$579

Leg Notes: Top and Bottom cut-out (8 1/2" x 8 1/2"). Grommets are standard only when ordered with wire trough. For silver trim base specify...N/C. Otherwise trim will match standard base color ordered.

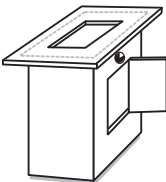

Square Panel Leg with Plinth Base, Access Door (24" Base for 42"D/48"D tables, 30" Base for 54" deep & up)

Model#	Depth	Width	Height	Price
MM LEG ASQWD1224	12"	24"	28"	\$873
MM LEG ASQWD1230	12"	30"	28"	\$1,077

Leg Notes: Top and Bottom cut-out (8 1/2" x 8 1/2"). Door size 12" x 12".

Grommets are standard only when ordered with wire trough.

For silver trim base specify...N/C. Otherwise trim will match standard base color ordered.

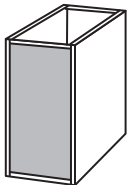

Square Panel Base w/End Access Door (24" Base for 42"D/48"D tables, 30" Base for 54" deep & up)

Model#	Depth	Width	Height	Price
MM LEG M1220WD	12"	20"	28"	\$354
MM LEG M1224WD	12"	24"	28"	\$373
MM LEG M1230WD	12"	30"	28"	\$468

Leg Notes: Top and Bottom open (no top). Grommets are standard only when ordered with wire trough. Plinth base N/A for these bases.

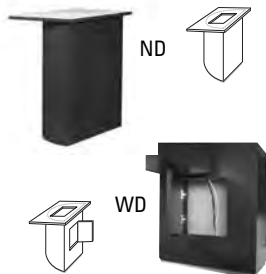

Half-Cylinder Base Hollow w/Access Door (24" leg for 36" tables, 24" leg for > 42" deep & 48" deep)

Model#	Depth	Width	Height	Price
MM LEG D24ND	12"	24"	28"	\$615
MM LEG D24WD	12"	24"	28"	\$834

Leg Notes: Top and Bottom cut-out (8 1/2" x 8 1/2"). Door size (12" x 12").

Grommets are standard only when ordered with wire trough.

Plinth base N/A for these bases.

NOTE:

Bases cut out are designed to fit Maverick standard power managements only.



Conference Collection

Power Management (Cut-out locations must be specified)

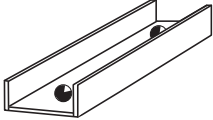

Wire Management Trough

Model#	Depth	Width	Height	Price
MM WMT	10"	varies	7"	\$122

Notes: Dimensions are based on conference table top sizes.
(2) bases requires (1) trough. (3) bases requires (2) troughs.



Plastic Black Power Management Unit Package (2 Phone, 3 Outlets and 1 USB)

Model#	Feature	Weight	Cube	Price
MM PWRDLX	Surge Protected - 10' Cord	2	1	\$337

Black Matte finish. **Specify center, left or right cutout location (see below).**
Note: Includes 8 wire-management clips. Includes top cutout (horizontal).
Data capability CAT5.



Brushed Silver Metal Power Management Unit Package (2 Phone, 2 Outlets and 1 USB)

Model#	Feature	Weight	Cube	Price
MM PWRDLX2	Surge Protected - 10' Cord	2	1	\$730

Metal Silver finish. **Specify center, left or right cutout location (see below).**
Note: Includes 8 wire-management clips. Includes top cutout (horizontal).
Data capability CAT5.



Metal Black PC Power Management Unit Package (4 CAT6 Ports, 1 HDMI, 1 VGA, 1 Audio, 12 Outlets and 4 USB)

Model#	Feature	Weight	Cube	Price
MM PWRUPCB	9 1/2" D x 30" W	24	2	\$3,761

Includes top cutout (8 1/4" x 29 1/8").

Center cut-out location only, horizontal. Cut-out N/A directly over bases (see below).
Data capability CAT6.

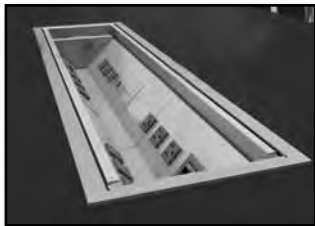

Metal Silver Pearl PC Power Management Unit Package (4 CAT6 Ports, 1 HDMI, 1 VGA, 1 Audio, 12 Outlets and 4 USB)

Model#	Feature	Weight	Cube	Price
MM PWRUPCS	9 1/2" D x 30" W	24	2	\$3,761

Includes top cutout (8 1/4" x 29 1/8").

Center cut-out location only, horizontal. Cut-out N/A directly over bases (see below).
Data capability CAT6.

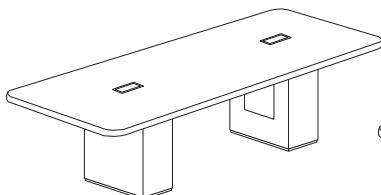

Shown: Left & right cut-out for...
MMPWRDLX or MMPWRDLX2

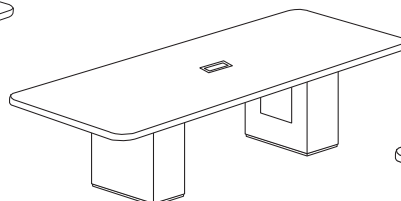

Shown: Center cut-out for...
All power management on this page

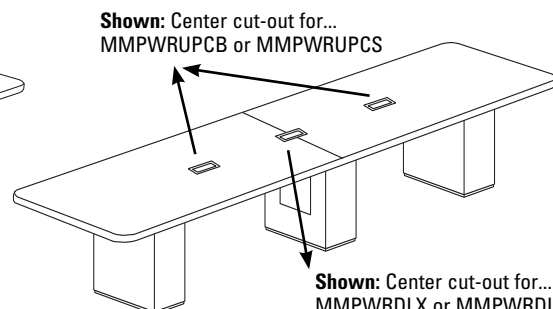

Shown: Center cut-out for...
MMPWRUPCB or MMPWRUPCS

Shown: Center cut-out for...
MMPWRDLX or MMPWRDLX2

Conference Collection

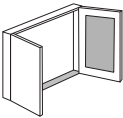
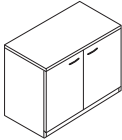
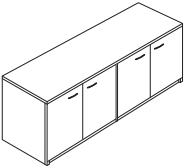
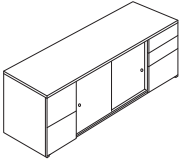
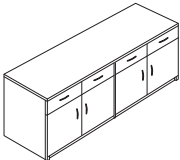
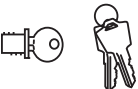

CONFERENCE ROOM FURNISHINGS

MODEL #							LIST PRICE BY SERIES					
SERIES (SPECIFY)	DEPTH	WIDTH	HEIGHT	WEIGHT	CUBE	MM (MAVERICK)						
							Conference Board (Optional projection screen, add \$300)					
CB36	6"	36"	36"	130	5	\$1,280						
CB48	6"	48"	48"	130	6	\$1,468						
 <p>Whiteboard with corkboard provided on inside of both doors. NOTE: Leaving marker writing on board for more than 48 hours will result in permanent stains.</p>												
Lectern (With casters)												
LEC	18"	24"	44"	92	11	\$536						
Hinged Door Utility Cabinet (H3B handles, one 3/4" thick adjustable shelf)												
HDC2036	20"	36"	29"	115	13	\$719						
HDC2042	20"	42"	29"	165	15	\$762						
HDC2436	24"	36"	29"	175	15	\$830						
HDC2442	24"	42"	29"	180	18	\$899						
 <p>Optional lock available, see below. Width coordinates with bookcase hutch.</p>												
Credenza, Full Hinged Door Storage (H3B handles, hinged doors, two adjustable 3/4" thick shelves)												
C2060 1FP	20"	60"	29"	220	21	\$1,447						
C2066 1FP	20"	66"	29"	240	23	\$1,570						
C2072 1FP	20"	72"	29"	260	25	\$1,590						
C2472 1FP	24"	72"	29"	295	30	\$1,728						
 <p>Optional face door locks available, see below. Two locks required.</p>												
Credenza, Full Pedestal F/F Left and B/B/F Right, Center Storage (Sliding doors)												
C2060 2FP	20"	60"	29"	220	21	\$1,570						
C2066 2FP	20"	66"	29"	240	23	\$1,754						
C2072 2FP	20"	72"	29"	260	25	\$1,770						
C2472 2FP	24"	72"	29"	290	30	\$1,816						
 <p>Storage includes adjustable 3/4" thick shelf. Optional locks available (wood doors only), see below.</p>												
Buffet Credenza, TFM Doors (H3B handles, hinged doors & box drawers)												
HDBC2036	20"	36"	36"	220	15	\$1,048						
HDBC2436	24"	36"	36"	240	18	\$1,150						
HDBC2072	20"	72"	36"	260	30	\$2,169						
HDBC2472	24"	72"	36"	290	36	\$2,264						
Buffet Credenza, Glass Doors (H3B handles, glass doors & box drawers)												
HDBC2072G	20"	72"	36"	260	30	\$2,955						
HDBC2472G	24"	72"	36"	290	36	\$3,048						
 <p>Storage includes one adjustable 3/4" thick shelf. Lateral file is locking. Optional face door lock available, glass doors no not lock, see below.</p>												
Face Lock												
MM FL						\$71						
 <p>One per set of two doors. Glass doors do NOT lock.</p>												

Conference



Training Tables

Product Specifications

- 1" thick tops only, 2 mm PVC edge-banding, pilot holes for post leg brackets only and metal inserts for ganging brackets.
- Maverick Series has radiused corners, Arroyo Series has straight corners.
- Available in 16 standard colors.
- No up-charge for contrasting color edge-banding.
- Legs and ganging hardware are ordered separately from the tops and are not factory installed.



How to Order Training Tables

WORKSURFACE UNITS:

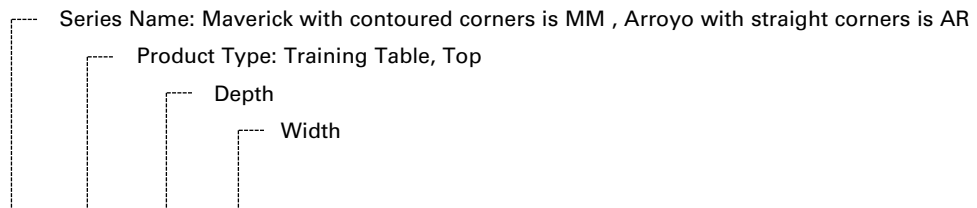

1. Product number: **MM TR 24 60**
2. Specify worksurface color - Choose from 16 standard colors. See Maverick Price List, inside back cover.
3. Specify edge-banding color - Matching top color is standard.
4. Specify other accessories and upgrades. See grommets, below.
5. Legs are ordered separately. Specify from available legs on pp. 152-153.
6. Ganging hardware is ordered separately. See p. 153.

MAVERICK SERIES (MM)

ARROYO SERIES (AR)

EDGE PROFILE

EDGE PROFILE

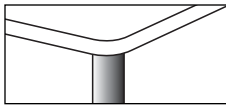

2 mm flat PVC edge banding on tops

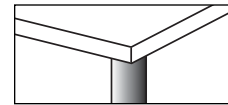

2mm flat PVC edge banding on tops

2 3/4" Plastic

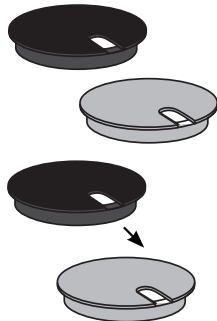

Grommet (Plastic cover, hole in surface, each)

Model#	Depth	Width	Surface Hole Diameter	Price
MM GR234B Black Plastic	3"	3"	2 3/4"	\$45
MM GR234S Silver Plastic	3"	3"	2 3/4"	\$45

Grommet Color, Change Standard Black to Silver (2 3/4" hole in surface, each)

Model#	Color	Depth	Width	Price
MM UGR234 Silver Plastic	Silver Plastic	3"	3"	No Charge

GrommetS (WORKSURFACE)

Note: While sitting at unit, grommet locations are named from left to right. Line drawings below show standard locations.

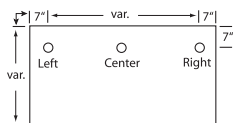

Rectangular
24" or 30"D

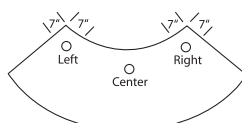

Curved
24" or 30"D

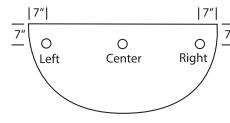

Half-Round
48" or 60"D

TOP GROMMET



Training Tables



QUICKSHIP 72-HOUR LEAD TIME

Training Worksurfaces

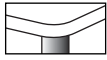

Maverick (MM)
Edge

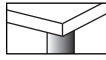

Arroyo (AR)
Edge



Maverick



Arroyo

Training table, rectangular, top only

Model#	Depth	Width	Height	Weight	Cube	MM Price	AR Price
__TR2436	24"	36"	1"	30	1	\$219	\$207
__TR2448	24"	48"	1"	30	1	\$219	\$207
__TR2460	24"	60"	1"	33	1	\$247	\$225
__TR2472	24"	72"	1"	39	1	\$275	\$250
__TR3048	30"	48"	1"	30	1	\$261	\$216
__TR3060	30"	60"	1"	47	1	\$261	\$241
__TR3072	30"	72"	1"	57	2	\$302	\$280

Note: When ordering, insert MM for Maverick Series or AR for Arroyo before model number. Woodgrain runs the width direction. Ganging inserts are centered, one on each depth end and on one width end. **Metal stretcher bars are standard when ordered with post legs, for 60" and 72" tops only.**

Metal stretcher bar (May be purchased separately)



Model#	Depth	Width	Height	Price
MM 50	2 1/2"	50"	1 1/2"	\$51
MM 60	2 1/2"	60"	1 1/2"	\$51

50" fits 60" tops. 60" fits 72" tops.

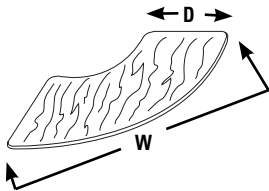

Maverick "R"
unit shown

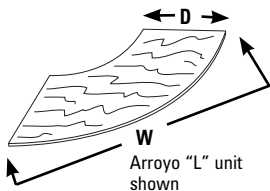

Arroyo "L"
unit shown

Training table, curved, top only (Must be ganged with another top for stability)

Model#	Depth	Width	Height	Weight	Cube	MM Price	AR Price
__TRQ2460L	24"	60"	1"	27	1	\$274	\$246
__TRQ2460R	24"	60"	1"	27	1	\$274	\$246
__TRQ3060L	30"	60"	1"	33	2	\$301	\$274
__TRQ3060R	30"	60"	1"	33	2	\$301	\$274

Note: When ordering, insert MM for Maverick Series or AR for Arroyo before model number. On "L" units, from users' view, woodgrain direction is parallel with right edge and perpendicular with left edge; on "R" units woodgrain is parallel with the left edge and perpendicular with the right edge. If not ganged, order 5th leg for stability.



Training Tables

QUICKSHIP 72-HOUR LEAD TIME

Training Worksurfaces

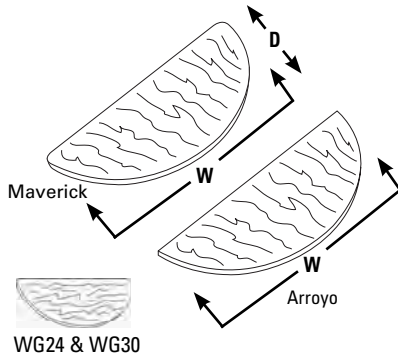

Training table, half-round, top only (48" & 60" require four legs and two ganging plates)

Model#	Depth	Width	Height	Weight	Cube	MM Price	AR Price
__TRWH1224	12"	24"	1"	6	1	\$136	\$108
__TRWH1224WG24	12"	24"	1"	6	1	\$136	\$108
__TRWH1530	15"	30"	1"	10	1	\$164	\$136
__TRWH1530WG30	15"	30"	1"	10	1	\$164	\$136
__TRWH2448	24"	48"	1"	24	1	\$343	\$315
__TRWH3060	30"	60"	1"	37	1	\$411	\$380

Note: When ordering, insert MM for Maverick Series or AR for Arroyo before model number. Woodgrain direction runs the depth to coordinate with woodgrain direction on rectangular worksurfaces. 12" & 15" deep require only one leg and one ganging plate. 12" & 15" deep (WG24 & WG30), the woodgrain runs the width to coordinate with the grain on one end of curved units.

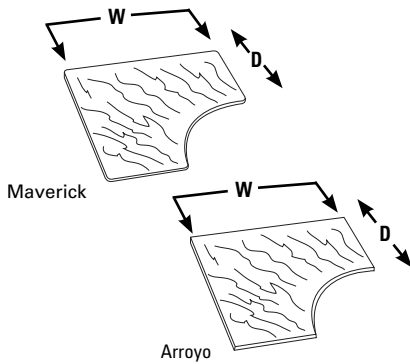

Training table, curved corner, top only (48" & 60" require four legs and two ganging plates)

Model#	Depth	Width	Height	Weight	Cube	MM Price	AR Price
__TRCWS424224	24"	42"	1"	24	1	\$355	\$315
__TRCWS424230	30"	42"	1"	24	1	\$355	\$315
__TRCWS484824	24"	48"	1"	30	1	\$412	\$366
__TRCWS484830	30"	48"	1"	30	1	\$412	\$412
__TRCWS606024	24"	60"	1"	47	1	\$516	\$463
__TRCWS606030	30"	60"	1"	47	1	\$516	\$463

Note: When ordering, insert MM for Maverick Series or AR for Arroyo before model number.



Training Tables



Training Bases



Flip Top Base w/casters (Black color only)

Model#	Depth	Width	Height	Weight	Cube	Price
MMLEGF4836	20"	24"	28 1/2"	42	1	\$326
MMLEGF7260	20"	58"	28 1/2"	42	1	\$453

Does not include top. FB 4836 Bases fit tops 36" and 48" wide. FB 7260 Bases fit tops 60" and 72" wide .
10-day lead time. Use with rectangular tops, see page 150. Weight capacity 250lbs.

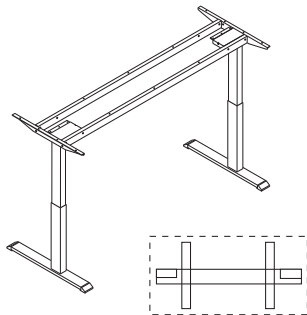

Adjustable height electrical legs (Silver only, sit to stand, fits top sizes below)

Model#	Depth	Width	Height	Weight	Cube	Price
MMLEGAHE-1	24-30"	36-48"	27-46"	61	1	\$1,861
MMLEGAHE-4*	24-30"	60-72"	27-46"	67	1	\$2,049

Does not include top. Leg fits top 36"-72" wide. **10-day lead time. Weight capacity...350lbs.**
 LB62 Included with MMLEGAHE-4. Legs adjust 27"-46 3/4"H sit to stand.

Base width requires top size:

Base Width	Top Width
26"	36"
38"	48"
50"	60"
62"	72"

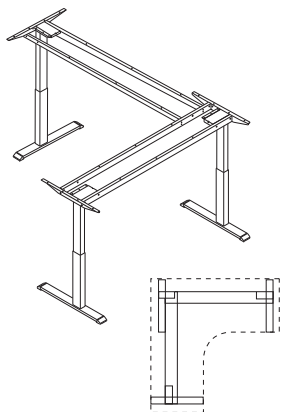

Adjustable height electrical L-unit legs (Silver only, sit to stand, fits top sizes below)

Model#	Depth	Width	Height	Weight	Cube	Price
MMLEGAHEL-2	24-30"	60/60"	23-49"	95	1	\$3,159

Does not include top. **Bases fit tops 60" wide only.** Legs adjust 23 3/4"-49"H sit to stand.
 One Leg brace LB50 included. **10-day lead time. Weight capacity...450lbs.**
Use with 60" curved corner top only, see page 151.

Leg brace (Silver)

Model#	Depth	Width	Height	Weight	Cube	Price
MMLB50*	1"	50"	4"	7	1	\$125
MMLB62**	1"	62"	4"	8	1	\$132

Recommended for additional stability for tops 42" wide and above, mounts to existing brackets.

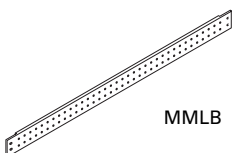



Training Tables

Accessories

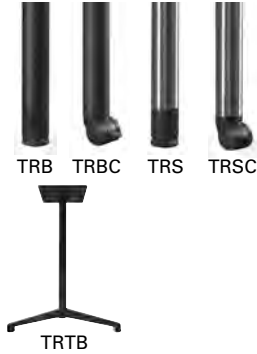

Conference table base upgrade options (Prices when ordered with table/worksurface)

► **NOTE: Leg Heights Vary and cannot be combined** ◀

Leg Style	Description	Height	Price
MM LEGTRB	4 Black Posts with Leveler	27 ¹³ / ₁₆ "	\$263
MM LEGTRS	4 Brushed Steel Posts with Leveler	27 ¹³ / ₁₆ "	\$263
MM LEGTRBC	4 Black Posts with Locking Casters	27 ¹⁵ / ₁₆ "	\$263
MM LEGTRSC	4 Brushed Steel Posts with Locking Casters	27 ¹⁵ / ₁₆ "	\$263
MM LEGTRTB	1 Fixed T-leg each	28 ⁷ / ₁₆ "	Each \$263

For Individual post legs...\$67 each. Specify model #MMCULEG_ (e.g. MMCU LEGTRB) for a single black post leg with adjustable leveler and 8 mounting screws. Legs are shipped un-installed and require minor assembly with 8 woodscrews for each leg. Tops are not pilot-hole pre-drilled for T-leg. Legs inset 4" from sides.

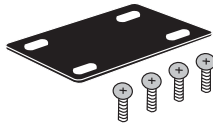

Ganging hardware (for use with factory-installed metal inserts)

Model#	Depth	Width	Height	Weight	Cube	Price
MM GANG4	4"	6"	.25"	1	1	\$32

Can be used for "L" shape & "U" shape connections

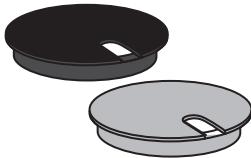

Grommet (Plastic cover, 2 ³/₄" hole in surface, each)

Model#	Color	Depth	Width	Price
MM GR234B	Black Plastic	3"	3"	\$45
MM GR234S	Silver Plastic	3"	3"	\$45

Specify grommet locations, see page 97.

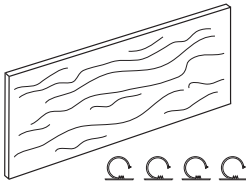

Modesties (To be ordered with Post Legs ONLY)

Model#	Depth	Width	Height	Weight	Cube	Price
MM TRM48	.75"	48"	12"	1	1	\$77
MM TRM60	.75"	60"	12"	1	2	\$103
MM TRM72	.75"	72"	12"	1	2	\$116

Includes (4) wire management clips. Includes installation hardware.

Training Tables



Configurations

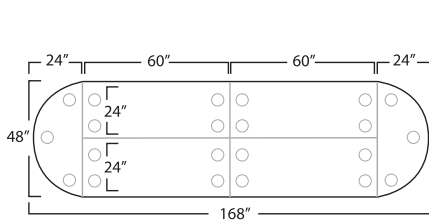

RACETRACK (Seats 10)

	MM	AR
4 __TR2460	\$988	\$900
2 __TRWH2448	\$686	\$630
5 MM LEGTR_*	\$1,449	\$1,449
6 MM GANG4	\$192	\$192
	\$3,315	\$3,171

* Includes (5) sets & (2) individual legs

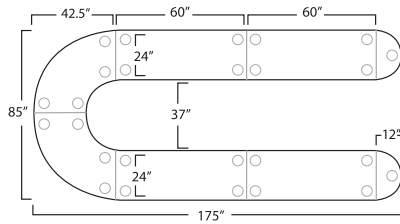

HORSESHOE (Seats 12)

	MM	AR
4 __TR2460	\$988	\$900
1 __TRQ2460L	\$274	\$246
1 __TRQ2460R	\$274	\$246
2 __TRWH1224	\$272	\$216
7 MM LEGTR_	\$1,712	\$1,712
7 MM GANG4	\$224	\$224
	\$3,744	\$3,544

* Includes (6) sets & (2) individual legs

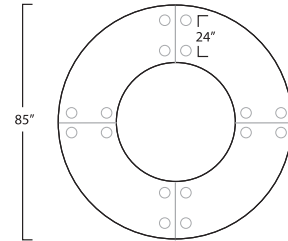

DONUT 24\"/>

	MM	AR
2 __TRQ2460L	\$548	\$492
2 __TRQ2460R	\$548	\$492
4 MM LEGTR_	\$1,052	\$1,052
4 MM GANG4	\$128	\$128
	\$2,276	\$2,164

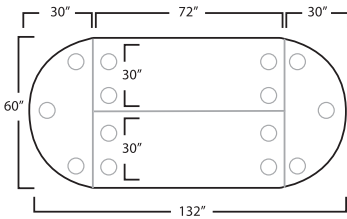

RACETRACK 30X72 (Seats 8)

	MM	AR
2 __TR3072	\$604	\$560
2 __TRWH3060	\$822	\$760
4 MM LEGTR_	\$1,052	\$1,052
5 MM GANG4	\$160	\$160
	\$2,638	\$2,532

* Includes (4) sets & (2) individual legs

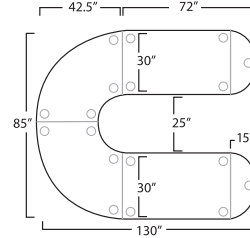

HORSESHOE (Seats 8)

	MM	AR
2 __TR3072	\$604	\$560
1 __TRQ3060L	\$301	\$274
1 __TRQ3060R	\$301	\$274
2 __TRWH1530	\$164	\$136
5 MM LEGTR_	\$1,119	\$1,119
5 MM GANG4	\$160	\$160
	\$2,649	\$2,523

* Includes (4) sets & (2) individual legs

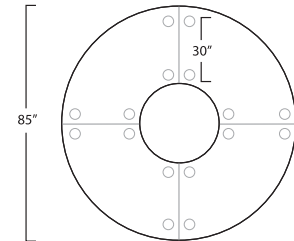

DONUT 30\"/>

	MM	AR
2 __TRQ3060L	\$602	\$548
2 __TRQ3060R	\$602	\$548
4 MM LEGTR_	\$1,052	\$1,052
4 MM GANG4	\$128	\$128
	\$2,384	\$2,276

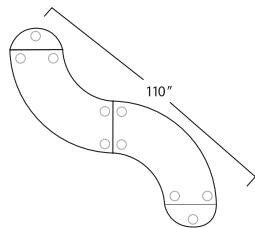

S TABLE 24\"/>

	MM	AR
2 __TRQ2460R	\$548	\$492
1 __TRWH1224	\$136	\$108
1 __TRWH1224WG24	\$136	\$108
3 MM LEGTR_	\$789	\$789
3 MM GANG4	\$96	\$96
	\$1,705	\$1,593

* Includes (2) sets & (4) individual legs

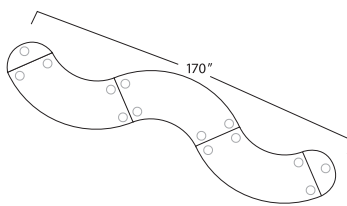

S TABLE 24\"/>

	MM	AR
3 __TRQ2460R	\$822	\$738
1 __TRWH1224	\$136	\$108
1 __TRWH1224WG24	\$136	\$108
4 MM LEGTR_	\$873	\$1,052
4 MM GANG4	\$128	\$128
	\$2,095	\$2,134

* Includes (3) sets & (2) individual legs

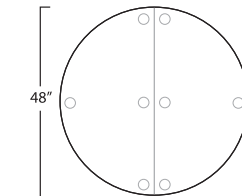

ROUND 48\"/>

	MM	AR
2 __TRWH2448	\$686	\$630
2 MM LEGTR_	\$526	\$526
2 MM GANG4	\$64	\$64
	\$1,276	\$1,220

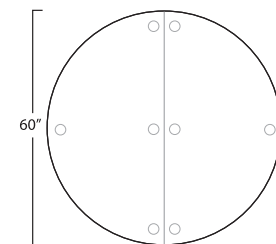

ROUND 60\"/>

	MM	AR
2 __TRWH3060	\$822	\$760
2 MM LEGTR_	\$526	\$526
2 MM GANG4	\$64	\$64
	\$1,412	\$1,350

Configurations are a small sample of total available.

Training Tables



Apex Series



a • pex: (noun)

The top or highest point of anything with an edge.

Features

Modern, clean-cut, contemporary styling. A full line of stand-alone casegoods and accessories for executive, team and panel-wrapped contract office settings. 21st Century design and aesthetics that adapt in design and style to any office environment.





Apex Series

Modern, clean-cut, contemporary styling. A full line of stand-alone casegoods and accessories for executive, team and panel-wrapped contract office settings. 21st Century design and aesthetics that adapt in design and style to any office environment.

Product Specifications

Colors

- 18 standard colors are available

Tops/Worksurfaces

- 1" TFM (Thermally Fused Melamine) on industrial quality (45 lb.) particleboard
- 2 mm thermally-fused PVC edge banding
- Woodgrain direction on tops is horizontal

Chassis Construction

- TFM chassis fastened by screws, steel brackets, and/or concealed fasteners
- Adjustable leveling glides are provided on all units
- Apex Series shipped with temporary nail glides - remove at time of installation
- Chassis are all $\frac{3}{4}$ " material including low credenza and free-standing storage tower

Drawer Interiors

- 9-ply Birch wood drawers

Drawer Suspension, Construction and Doors

- Drawers have full-extension, progressive-action slides with precision steel ball bearings
- APH1 handles standard
- Overlay drawer front and doors are standard on all separate storage units and separate file units
- All file and lateral drawers file legal size from side to side and letter front to back
- File drawer construction accommodates hanging files not stacked material on drawer bottom
- Hutch doors overlay with 20" clearance below shelf

Cord Management

- A grommet is standard on all worksurfaces
- Optional wire management is available - see page AP31

Locks

- Locks standard on all support pedestals
- Silver, removable cores are standard for all locks
- Pedestal key numbers are randomly assigned to all locking pedestals
- Master keys and keyed-alike combinations are available.



Note: Dimensions assigned in this price list are nominal. If exact measurements are required, the requirement must be specified in the order and specifically acknowledged by Maverick. Maverick reserves the right to change construction details and standards without notification, if necessary.

Apex Series



How to Order Apex Series

WORKSURFACE UNITS: TOPS, BASES, SUPPORTS

Series Name: Apex

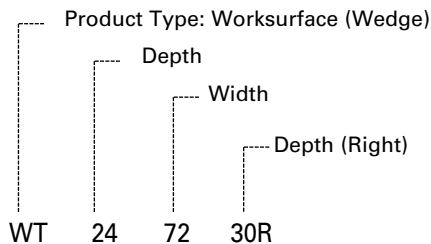

- Specify worksurface finish
- Specify other accessories and upgrades. See page AP33.

Worksurfaces (p. AP12)

- Available in 18 colors
- Specify **APWT 2 4 7 2 3 0 R**

Privacy Screens (p. AP21)

- Frosted acrylic screens are mounted to worksurfaces.
- Specify **APPSU 7 2**

Low Credenza Support (p. AP19-20)

- Attaches to worksurfaces to add support between low credenzas and tops.
- Specify **APSLEG 2 4**

Low Credenzas (p. AP22-23)

- Available in a myriad of configurations to meet several storage considerations
- Specify **APSBL 2 0 7 2 R**



Worksurface Supports (p. AP18-20)

- Worksurface support legs are ordered separately
- Required for supporting available Apex worksurfaces
- Specify **APODL 3 0**



SILVER GROMMET (APGRSQS)

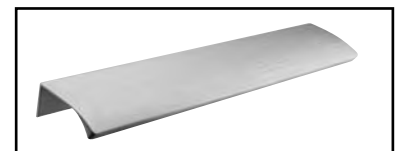

HANDLE (APH1)



Apex Series

Statement of Line

WORKSURFACES:

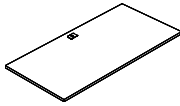

Rectangular
(APRT_...)

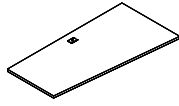

Wedge
(APWT_...)

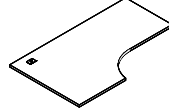

Extended Compu-Corner
(APET_...)

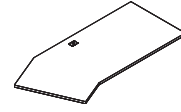

Compu-Corner Angled
(APAT_...)

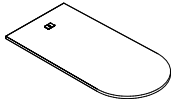

Bullet
(APBD_...)

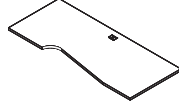

Saddle Compu-Corner
(APST_...)

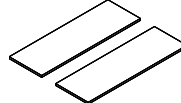

Rectangular Shared
(APRECH_...)

WORKSURFACE SUPPORTS:

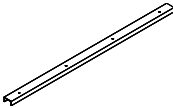

External Stabilizer Bar
(APSB_...)

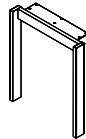

Double Post
(APODPL_...)

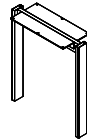

Shared Double Post Leg
(APDPML_...)

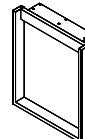

D-Leg
(APODL_...)

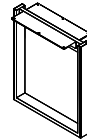

Shared D-leg
(APMDL_...)



28" Single Post
(APSPL28)



T-Leg
(APTLEG_...)

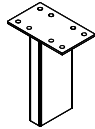

6" Single Post
(APSPL6)

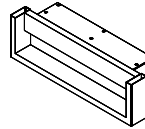

Short D-Leg
(APOS DL_...)

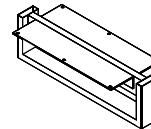

Short D-leg (Shared)
(APMSDL_...)

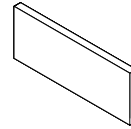

TFM Low Credenza
(APSLG_...)

SUPPORT PEDESTALS:

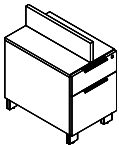

Box/File
(APPED A_ BF)

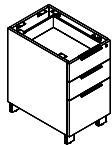

Box/Box/File
(APPED C_ BBF)

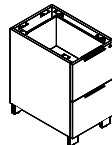

File/File
(APPED D_ FF)

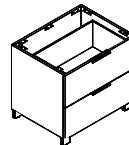

Lateral File
(APPED _ _ LF)

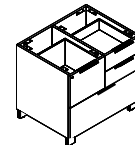

Personal Lateral File
(APPED _ _ PLF)

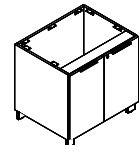

Hinged Door Cabinet
(APPED _ _ HDC)

PRIVACY SCREENS:

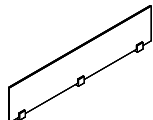

Top Frosted Acrylic
(APPSU_...)

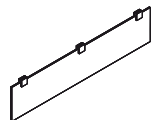

Frosted Acrylic Modesty
(APPSL_...)

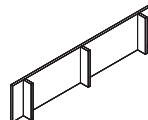

(TFM) Modesty
(APPSLW_...)

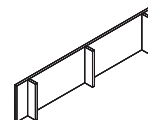

(HPL) Modesty
(APPSLHP_...)

LOW CREDENZAS:

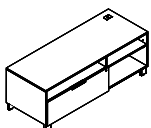

Single Lateral File
(APSLO_...)

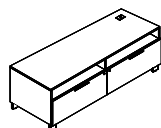

Double Lateral File
(APDOL_...)

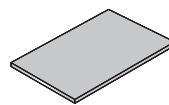

Cushion
(APCUH_...)

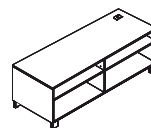

Open
(APDO_...)

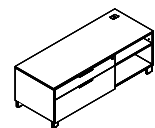

Single Box/Lateral
(APSBL_...)

Apex Series



Statement of Line

HUTCH/OVERHEAD STORAGE:

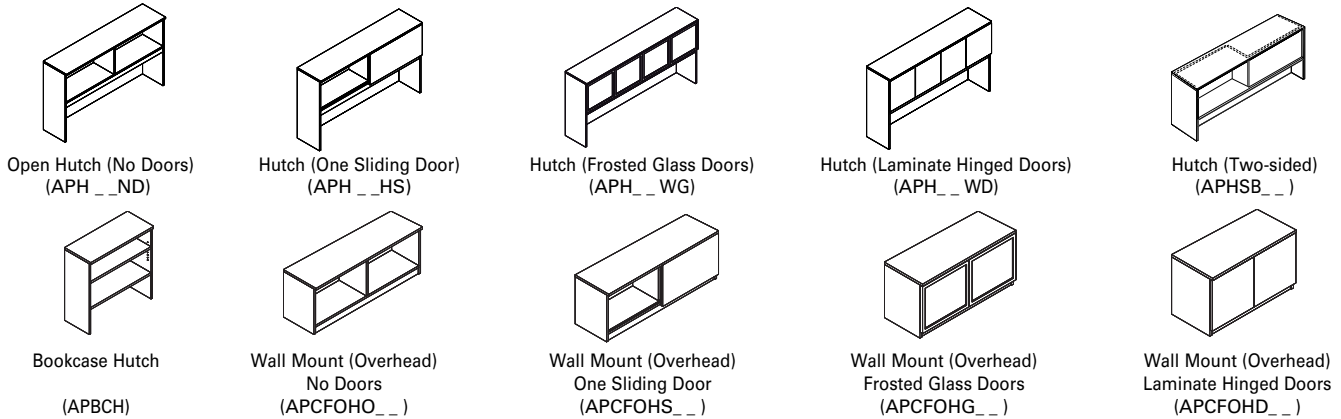

FREESTANDING STORAGE:

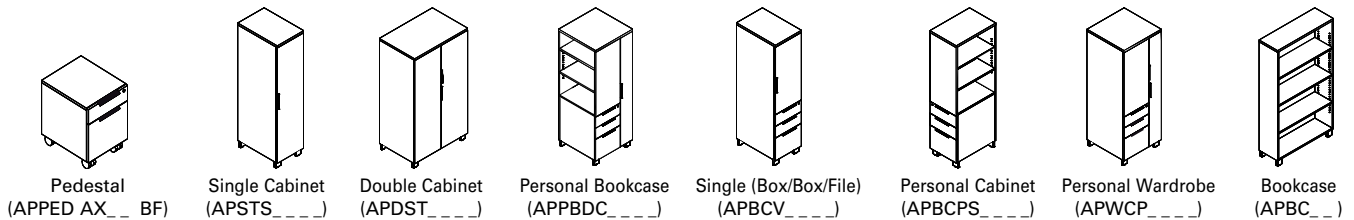

TACKBOARDS:

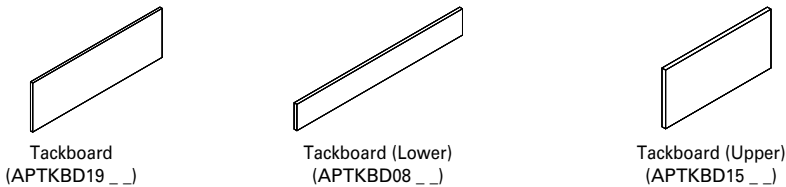

BASES:

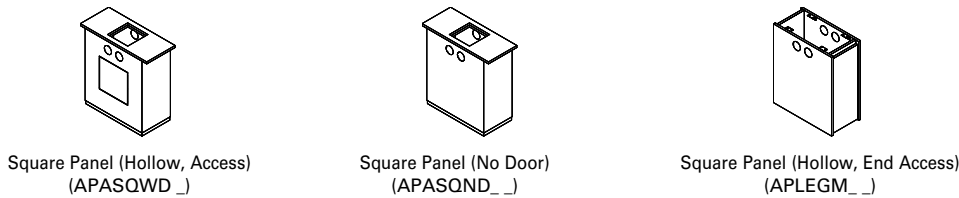

ELECTRICAL:

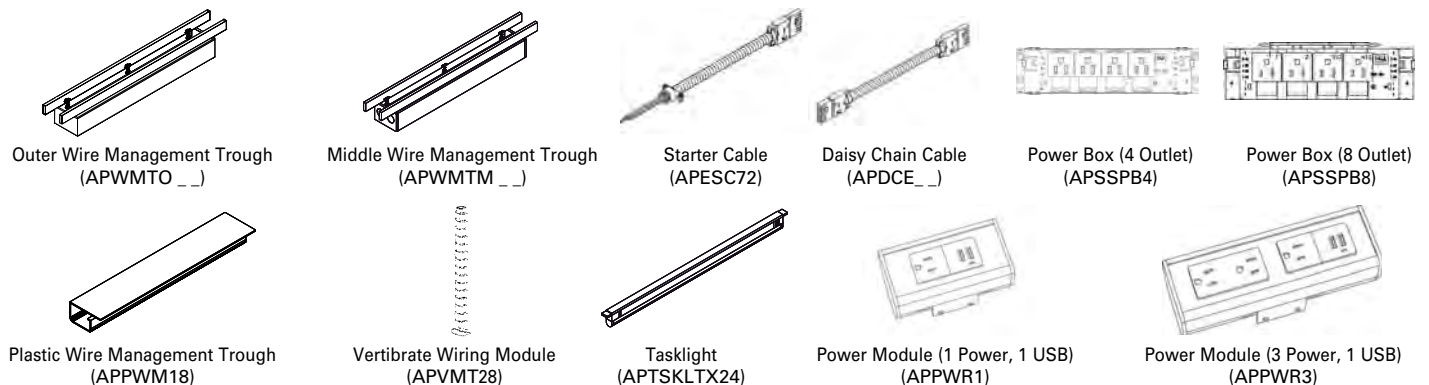



Apex Series

Power Management

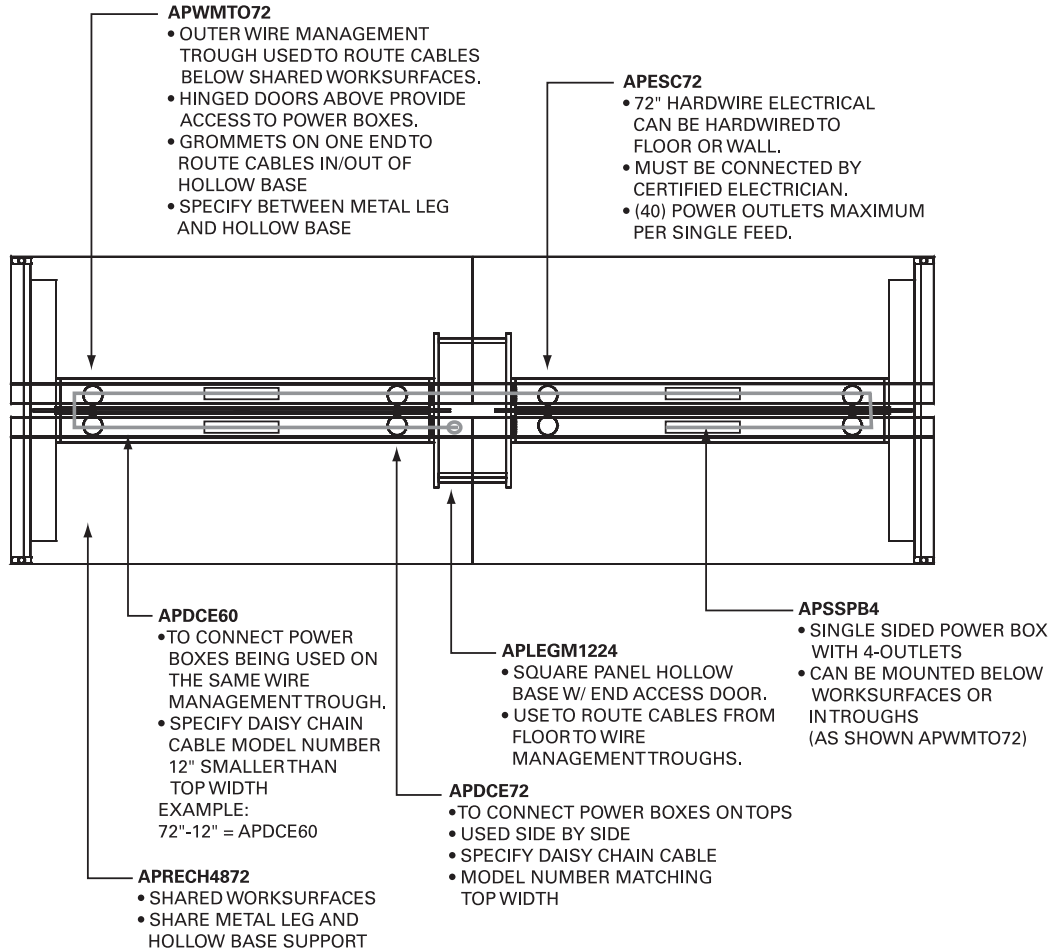

Apex Series



Configurations

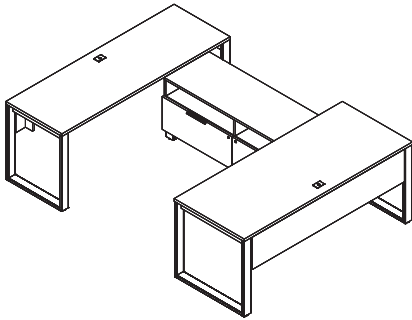

AP1L

Qty	Model #	Description	List Price	Extended Price
1	APRT3072	Rectangular Top Worksurface (30"x72")	\$347	\$347
1	APRT2472	Rectangular Top Worksurface (24"x72")	\$310	\$310
2	APODL30	D-Leg (30"Dx28"H)	\$370	\$740
2	APODL24	D-Leg (24"Dx28"H)	\$350	\$700
2	APSB72	External Stabilizer Bar (2"Dx1"Hx56"W)	\$75	\$150
2	APPSLHP72	Lower HPL Privacy Screen (12"Hx65"W)	\$222	\$444
1	APDOL2061L	Low Double Lateral File Credenza, Left (20"Hx61"Dx22"H)	\$1,700	\$1,700
TOTAL			\$1,700	\$4,391

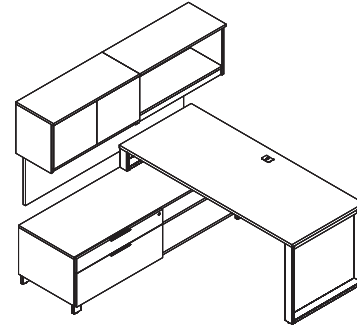

AP2L

Qty	Model #	Description	List Price	Extended Price
1	APRT3072	Rectangular Top Worksurface (30"x72")	\$347	\$347
1	APODL30	D-Leg (30"Dx28"H)	\$370	\$370
1	APOSDL30	Short D-leg (30"Dx6"H)	\$390	\$390
1	APSB72	External Stabilizer Bar (2"Dx1"Hx56"W)	\$75	\$75
1	APSBL2472L	Low Single Box/Lateral Credenza, Left (24"Dx72"Wx22"H)	\$1,700	\$1,700
1	APCFOHD36	Wall Mounted Overhead Cabinet with Hinged Doors	\$715	\$715
1	APCFOHO36	Wall Mounted Overhead Cabinet with no Doors	\$565	\$565
1	APTkbd1972	Tackboard (70"Wx19"H)	\$490	\$490
TOTAL			\$4,652	\$4,652

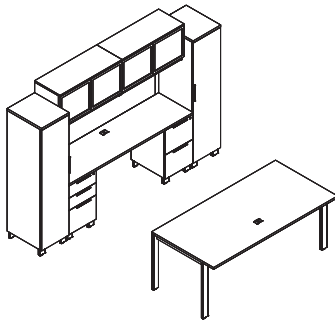

AP3

Qty	Model #	Description	List Price	Extended Price
1	APRT3672	Rectangular Top Worksurface (36"Dx72"W)	\$377	\$377
1	APRT2072	Rectangular Top Worksurface (20"Dx72"W)	\$297	\$297
2	APODPL30	Double Post Leg (30"Dx28"H)	\$305	\$610
1	APSB72	External Stabilizer (2"Dx1"Hx56"W)	\$75	\$75
1	APPED C20 BBF	Supporting Box/Box/File, No Top (20"Dx16"Wx28"H)	\$984	\$984
1	APPED D20 FF	Supporting File/File, No Top (20"Dx16"Wx28"H)	\$930	\$930
2	APCFOHO36	Wall Mounted Overhead Cabinet with Frosted Glass Doors (14 3/4"Dx36"Wx18 1/2"H)	\$860	\$1,720
1	APTkbd1972	Tackboard (70"Wx19"H)	\$490	\$490
1	APSTS2065L	Single Storage Cabinet, Left (20"Dx16"Wx65"H)	\$1,300	\$1,300
1	APSTS2065R	Single Storage Cabinet, Right (20"Dx16"Wx65"H)	\$1,300	\$1,300
TOTAL			\$8,083	\$8,083

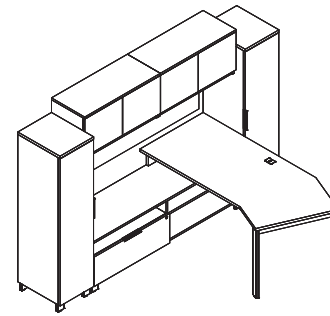

AP4L

Qty	Model #	Description	List Price	Extended Price
1	APAT3072 20R	Angle Compu-Corner Worksurface (30"Dx72"W)	\$473	\$473
1	APODPL30	Double Post Leg (30"Dx28"H)	\$305	\$305
1	APSLLEG30	Low Credenza TFM Support (24"Dx6"H)	\$80	\$80
1	APSB72	External Stabilizer Bar (2"Dx1"Hx56"W)	\$75	\$75
1	APSLQ2072L	Low Single Lateral Credenza, Left (20"Dx72"Wx22"H)	\$1,600	\$1,600
2	APCFOHD36	Wall Mounted Overhead Cabinet with Hinged Doors	\$715	\$1,430
1	APTkbd1972	Tackboard (70"Wx19"H)	\$490	\$490
1	APSTS2065L	Single Storage Cabinet, Left (20"Dx16"Wx65"H)	\$1,300	\$1,300
1	APSTS2065R	Single Storage Cabinet, Right (20"Dx16"Wx65"H)	\$1,300	\$1,300
TOTAL			\$7,053	\$7,053

Configurations are a small sample of total available.



Apex Series

Configurations

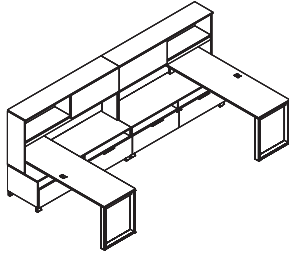

AP5				
Qty	Model #	Description	List Price	Extended Price
2	APRT2472	Rectangular Top Worksurface (24"x72")	\$310	\$620
2	APODL24	D-Leg (24"Dx28"H)	\$350	\$700
2	APSLEG24	Low Credenza TFM Support (18"Dx6"H)	\$75	\$150
2	APSB72	External Stabilizer Bar (2"Dx1"Hx56"W)	\$75	\$150
1	APODL2472L	Double Lateral File w/Open Shelf Credenza, Left (24"Dx72"Wx22"H)	\$1,830	\$1,830
1	APODL2472R	Double Lateral File w/Open Shelf Credenza, Right (24"Dx72"Wx22"H)	\$1,830	\$1,830
2	APH72 SD	Hutch w/One Sliding Door (14"Dx72"Wx36"H)	\$1,030	\$2,060
2	APTKBD1972	Hutch Tackboard (1"Dx70"Wx19"H)	\$490	\$980
		TOTAL		\$8,320

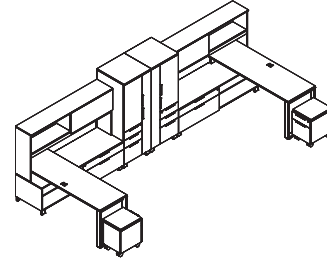

AP6				
Qty	Model #	Description	List Price	Extended Price
2	APRT2472	Rectangular Top Worksurface (24"x72")	\$310	\$620
2	APODL24	D-Leg (24"Dx28"H)	\$350	\$700
2	APSLEG24	Low Credenza TFM Support (18"Dx6"H)	\$75	\$150
2	APSB72	External Stabilizer Bar (2"Dx1"Hx56"W)	\$75	\$150
1	APSBL2472L	Single Box/Lateral Credenza, Left (24"Dx72"Wx22"H)	\$1,700	\$1,700
1	APSBL2472R	Single Box/Lateral Credenza, Right (24"Dx72"Wx22"H)	\$1,700	\$1,700
2	APH72 SD	Hutch w/One Sliding Door (14"Dx72"Wx36"H)	\$1,030	\$2,060
2	APTKBD1972	Hutch Tackboard (1"Dx70"Wx19"H)	\$490	\$980
2	APPED AX20 BF	Mobile Box/File Pedestal (19"Dx16"Wx22"H)	\$785	\$1,570
2	APCUH2016	Pedestal Cushion (19"Dx16"W)	\$150	\$300
1	APWCP2465R	Personal Wardrobe w/Storage Cabinet, Right (24"Dx24"Wx65"H)	\$1,555	\$1,555
1	APWCP2465L	Personal Wardrobe w/Storage Cabinet, Left (24"Dx24"Wx65"H)	\$1,555	\$1,555
		TOTAL		\$13,040

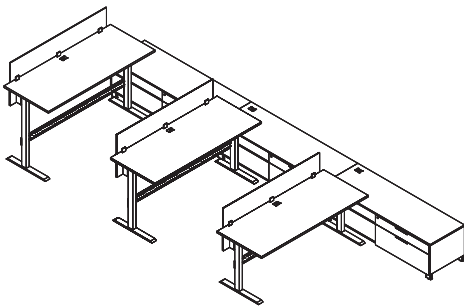

AP7R				
Qty	Model #	Description	List Price	Extended Price
3	APRT3072	Rectangular Top Worksurface (30"Dx72"W)	\$347	\$1,041
3	MMLEGAHE-4	Adjustable Height Electrical Legs (24/30"Dx72"Wx23-48"H)	\$1,897	\$5,691
3	APPSU72	Top Frosted Acrylic Privacy Screen (65"Wx12"Hx1"D)	\$530	\$1,590
3	APPSLHP72	Lower HPL Privacy Screen (65"Wx12"H)	\$222	\$666
3	APSBL2472R	Single Box/Lateral Credenza, Right (24"Dx72"Wx22"H)	\$1,700	\$5,100
		TOTAL		\$14,088

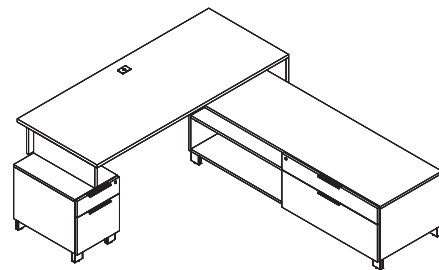

AP8R				
Qty	Model #	Description	List Price	Extended Price
1	APRT3072	Rectangular Top Worksurface (30"Dx72"W)	\$347	\$347
1	APPED A24 BF	Supporting Box/File Pedestal (24"Dx16"Wx28"H)	\$940	\$940
1	APTEG30	T-Leg (30"Dx12"Wx28"H)	\$135	\$135
1	APSB72	External Stabilizer Bar (2"Dx65"Wx1"H)	\$75	\$75
1	APPSLHP72	Lower HPL Privacy Screen (65"Wx12"H)	\$222	\$222
1	APSBL2472R	Single Box/Lateral Credenza, Right (24"Dx72"Wx22"H)	\$1,700	\$1,700
		TOTAL		\$3,419

Apex Series



Configurations

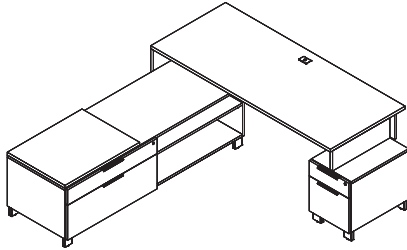

AP9L			List Price	Extended Price
Qty	Model #	Description		
1	APRT3072	Rectangular Top Worksurface (30"Dx72"W)	\$347	\$347
1	APPED A24 BF	Supporting Box/File Pedestal (24"Dx16"Wx28"H)	\$940	\$940
1	APTLG30	T-Leg (30"Dx12"Wx28"H)	\$135	\$135
1	APSB72	External Stabilizer Bar (2"Dx65"Wx1"H)	\$75	\$75
1	APPSLHP72	Lower HPL Privacy Screen (65"Wx12"H)	\$222	\$222
1	APSB2472L	Single Box/Lateral Credenza, Left (24"Dx72"Wx22"H)	\$1,700	\$1,700
1	APCUH2430	Credenza Cushion (23"Dx30"W)	\$178	\$178
		TOTAL		\$3,597

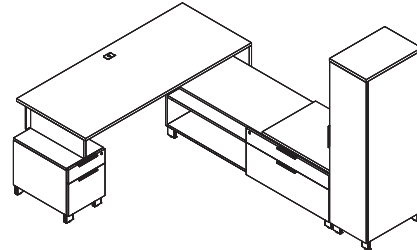

AP10R			List Price	Extended Price
Qty	Model #	Description		
1	APRT3072	Rectangular Top Worksurface (30"Dx72"W)	\$347	\$347
1	APPED A24 BF	Supporting Box/File Pedestal (24"Dx16"Wx28"H)	\$940	\$940
1	APTLG30	T-Leg (30"Dx12"Wx28"H)	\$135	\$135
1	APSB72	External Stabilizer Bar (2"Dx65"Wx1"H)	\$75	\$75
1	APPSL72	Lower Frosted Acrylic Privacy Screen (65"Wx12"H)	\$530	\$530
1	APSB2472R	Single Box/Lateral Credenza, Right (24"Dx72"Wx22"H)	\$1,700	\$1,700
1	APCUH2430	Credenza Cushion (23"Dx30"W)	\$178	\$178
1	APSTS2465R	Single Storage Cabinet, Right (24"Dx16"Wx65"H)	\$1,300	\$1,300
		TOTAL		\$5,205

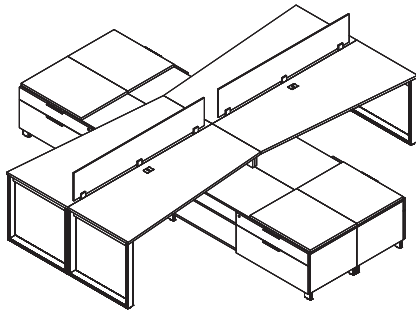

AP11			List Price	Extended Price
Qty	Model #	Description		
2	APWT2472 30L	Wedge Top Worksurface (30/24"Dx72"W)	\$362	\$724
2	APWT2472 30R	Wedge Top Worksurface (24/30"Dx72"W)	\$362	\$724
4	APODL30	D-Leg (30"Dx28"H)	\$370	\$1,480
4	APSLG30	Low Credenza TFM Support (24"Dx6"H)	\$80	\$320
4	APSB72	External Stabilizer Bar (2"Dx65"Wx1"H)	\$75	\$300
2	APPSU72	Top Frosted Acrylic Privacy Screen (65"Wx12"H)	\$530	\$1,060
2	APSB2472R	Single Box/Lateral Credenza, Right (24"Dxx72"Wx22"H)	\$1,700	\$3,400
2	APSB2472L	Single Box/Lateral Credenza, Left (24"Dx72"Wx22"H)	\$1,700	\$3,400
4	APCUH2430	Credenza Cushion (23"Dx30"W)	\$178	\$712
		TOTAL		\$12,120

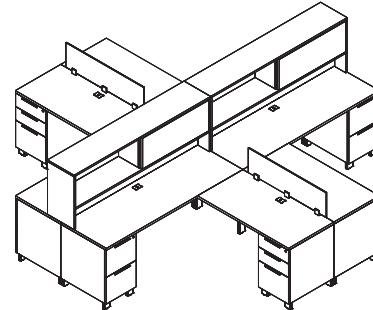

AP12			List Price	Extended Price
Qty	Model #	Description		
4	APRT2472	Rectangular Top Worksurface (24"Dx72"W)	\$310	\$1,240
2	APHSB72	Two-sided Hutch, Shared Bins (14"Dx36"Hx72"W)	\$825	\$1,650
4	APRT2448	Rectangular Top Worksurface (24"Dx48"W)	\$210	\$840
2	APDPML24	Shared Double Post Leg (24"Dx28"H)	\$355	\$710
4	APPED C24 BBF	Supporting Box/Box/File Pedestal (24"Dx16"Wx28"H)	\$990	\$3,960
4	APPED D24 FF	Supporting File/File Pedestal (24"Dx16"Wx28"H)	\$950	\$3,800
4	APSB60	External Stabilizer Bar (44"W)	\$65	\$260
2	APPSU48	Top Frosted Acrylic Privacy Screen (41"Wx12"H)	\$360	\$720
4	APTKBD0872	Lower Tackboard (70"Wx8"H)	\$330	\$1,320
4	APTKBD1536	Upper Tackboard (35"Wx15"H)	\$300	\$1,200
		TOTAL		\$15,700



Apex Series

Configurations

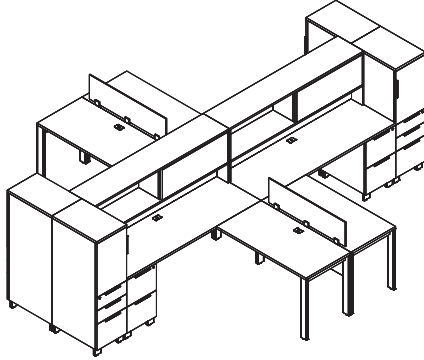

AP13

Qty	Model #	Description	List Price	Extended Price
4	APRT2472	Rectangular Top Worksurface (24"Dx72"W)	\$310	\$1,240
4	APRT2448	Rectangular Top Worksurface (24"Dx48"W)	\$210	\$840
4	APODPL24	Double Post Leg (24"Dx28"H)	\$285	\$1,140
2	APDPML24	Shared Double Post Leg (24"Dx28"H)	\$355	\$710
4	APPED D24 FF	Supporting File/File Pedestal (24"Dx16"Wx28"H)	\$950	\$3,800
4	APSB60	External Stabilizer Bar (44"W)	\$65	\$260
2	APPSU48	Top Frosted Acrylic Privacy Screen (41"Wx12"H)	\$360	\$720
2	APBCV2454L	Single Storage Box/Box/File Upper Door, Left (24"Dx16"Wx54"H)	\$1,555	\$3,110
2	APBCV2454R	Single Storage Box/Box/File Upper Door, Right (24"Dx16"Wx54"H)	\$1,555	\$3,110
2	APHSB72	Two-sided Hutch w/ Shared Bins (14"Dx72"Wx25"H)	\$825	\$1,650
4	APTKBD0872	Lower Tackboard (70"Wx8"H)	\$330	\$1,320
4	APTKBD1536	Upper Tackboard (35"Wx15"H)	\$300	\$1,200
		TOTAL		\$19,100

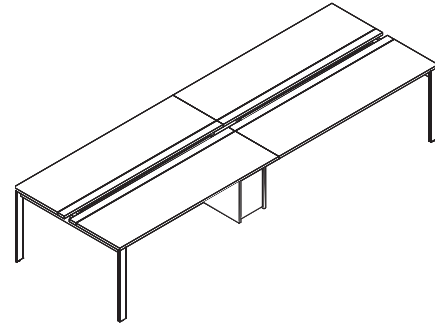

AP14

Qty	Model #	Description	List Price	Extended Price
2	APRECH4872	Shared Rectangular Top Worksurface (48"Dx72"W)	\$620	\$1,240
2	APODPL48	Double Post Leg (48"Dx28"H)	\$375	\$750
2	APWMT072	Outer Wire Management Trough (59"Wx8"Hx10"D)	\$730	\$1,460
4	APSB72	External Stabilizer Bar (56"W)	\$75	\$300
1	APLEGM1224	Square Panel Base Hollow, w/End Access Door (12"Dx24"W)	\$380	\$380
1	APESC72	System Hardware Electrical Starter Cable (72")	\$172	\$172
4	APSSPB4	Single Sided Power Box w/4-Power Outlets	\$135	\$540
2	APDCE60	52" Daisy Chain Electrical Cable	\$172	\$344
1	APDCE72	64" Daisy Chain Electrical Cable	\$190	\$190
		TOTAL		\$5,376

Apex Series



Configurations

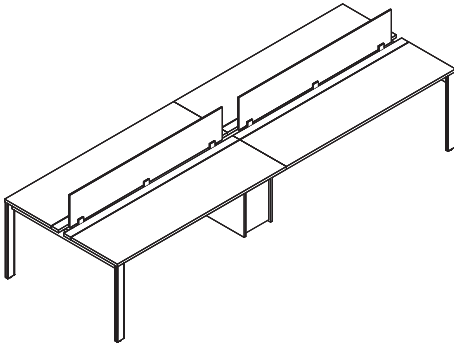

AP15

Qty	Model #	Description	List Price	Extended Price
2	APRECH4872	Rectangular (Shared) Worksurface (48" Dx72"W)	\$620	\$1,240
2	APODPL48	Double Post Leg (48" Dx28"H)	\$375	\$750
2	APWMT072	Outer Wire Management Trough (59"Wx8"Hx10"D)	\$730	\$1,460
4	APSB72	External Stabilizer Bar (56"W)	\$75	\$300
1	APLEGM1224	Square Panel Base Hollow, w/End Access Door (12"Dx24"W)	\$380	\$380
2	APPSU72	Top Frosted Acrylic Privacy Screen (65"Wx12"H)	\$530	\$1,060
1	APESC72	System Hardware Electrical Starter Cable (72")	\$172	\$172
4	APSSPB4	Single Sided Power Box w/4-Power Outlets	\$135	\$540
2	APDCE60	52" Daisy Chain Electrical Cable	\$172	\$344
1	APDCE72	64" Daisy Chain Electrical Cable	\$190	\$190
		TOTAL		\$6,436

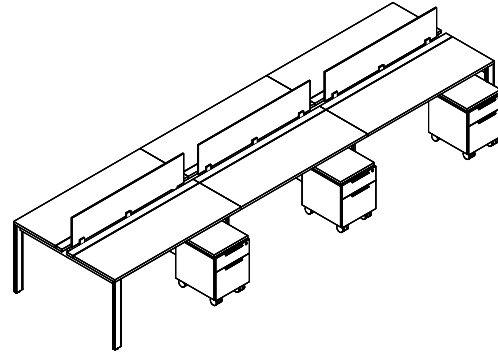

AP16

Qty	Model #	Description	List Price	Extended Price
3	APRECH4860	Rectangular (Shared) Worksurface (48" Dx60"W)	\$557	\$1,671
2	APODPL48	Double Post Leg (48" Dx28"H)	\$375	\$750
1	APWMTM60	Middle Wire Management Trough (48"Wx8"Hx10"D)	\$590	\$590
2	APWMT060	Outer Wire Management Trough (47"Wx8"Hx10"D)	\$580	\$1,160
6	APSB60	External Stabilizer Bar (44"W)	\$65	\$390
2	APLEGM1224	Square Panel Base Hollow, w/End Access Door (12"Dx24"W)	\$380	\$760
3	APPSU60	Top Frosted Acrylic Privacy Screen (53"Wx12"H)	\$520	\$1,560
6	APPED AX20 BF	Mobile Box/File Pedestal (19"Dx16"Wx22"H)	\$785	\$4,710
1	APESC72	System Hardware Electrical Starter Cable (72")	\$172	\$172
6	APSSPB4	Single Sided Power Box w/4-Power Outlets	\$135	\$810
2	APDCE48	40" Daisy Chain Electrical Cable	\$155	\$310
3	APDCE60	52" Daisy Chain Electrical Cable	\$172	\$516
		TOTAL		\$13,399



Apex Series

Configurations

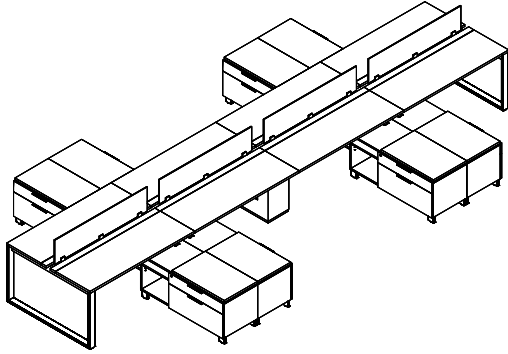

AP17

Qty	Model #	Description	List Price	Extended Price
4	APRECH4860	Rectangular (Shared) Worksurface (48" Dx60"W)	\$557	\$2,228
2	APODL48	D-Leg (48" Dx28"H)	\$435	\$870
2	APWMT060	Outer Wire Management Trough (47"Wx8"Hx10"D)	\$580	\$1,160
2	APWMTM60	Middle Wire Management Trough (48"Wx8"Hx10"D)	\$590	\$1,180
8	APSB60	External Stabilizer Bar (44"W)	\$65	\$520
2	APLEGASQND1224	Square Panel Base Hollow, No Door (12"Dx24"W)	\$510	\$1,020
1	APLEGASQWD1224	Square Panel Base Hollow, w/Access Door (12"Dx24"W)	\$840	\$840
4	APPSU60	Top Frosted Acrylic Privacy Screen (53"Wx12"H)	\$520	\$2,080
4	APSBL2048R	Single Box/Lateral Credenza, Right (20"Dx48"Wx22"H)	\$1,455	\$5,820
4	APSBL2048L	Single Box/Lateral Credenza, Left (20"Dx48"Wx22"H)	\$1,455	\$5,820
8	APCUH2030	Low Credenza Cushion (19"Dx30"Wx1"H)	\$168	\$1,344
1	APESC72	System Hardware Electrical Starter Cable (72")	\$172	\$172
8	APSSPB4	Single Sided Power Box w/4-Power Outlets	\$135	\$1,080
2	APDCE48	40" Daisy Chain Electrical Cable	\$155	\$310
5	APDCE60	52" Daisy Chain Electrical Cable	\$172	\$860
		TOTAL		\$25,304

Apex Series



Worksurfaces

Rectangular Worksurface

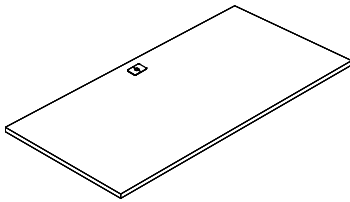

Model#	Depth	Width	Height	Price
APRT2030	20"	30"	1"	\$170
APRT2031	20"	31"	1"	\$170
APRT2036	20"	36"	1"	\$176
APRT2042	20"	42"	1"	\$184
APRT2048	20"	48"	1"	\$197
APRT2054	20"	54"	1"	\$233
APRT2060	20"	60"	1"	\$260
APRT2062	20"	62"	1"	\$264
* APRT2066	20"	66"	1"	\$288
* APRT2072	20"	72"	1"	\$297
APRT2430	24"	30"	1"	\$181
APRT2431	24"	31"	1"	\$181
APRT2436	24"	36"	1"	\$187
APRT2442	24"	42"	1"	\$201
APRT2448	24"	48"	1"	\$210
APRT2454	24"	54"	1"	\$264
APRT2460	24"	60"	1"	\$278
APRT2462	24"	62"	1"	\$280
* APRT2466	24"	66"	1"	\$297
* APRT2472	24"	72"	1"	\$310
APRT3048	30"	48"	1"	\$230
APRT3054	30"	54"	1"	\$297
APRT3060	30"	60"	1"	\$305
* APRT3066	30"	66"	1"	\$331
* APRT3072	30"	72"	1"	\$347
APRT3660	36"	60"	1"	\$334
* APRT3666	36"	66"	1"	\$360
* APRT3672	36"	72"	1"	\$377

One silver square grommet (top center) standard.

Grommet on 20", 24" & 30"D is 3" clear from approach. On 36"D is 9" clear from approach.

Depending on support configuration, external stabilizer may be required on tops of 54" or greater.

See external stabilizer bar selection guide on page 174.

* 2 stabilizer bars are required on 66" & 72" wide worksurfaces when supporting with left & right Double post leg, D-legs or T-legs

Ganging hardware

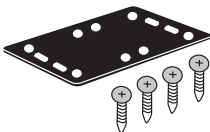

Model#	Depth	Width	Height	Price
AP GANG1	4"	6"	.25"	\$30
AP GANG2	4"	6"	.25"	\$60

NOTE: Must be field installed

* If using as a return top, specify APGANG1 (2 brackets w/#8x1" wood screws supplied).

* If using as a Bridge Top, specify APGANG2 (4 brackets w/#8x1" wood screws supplied).



Apex Series

Worksurfaces

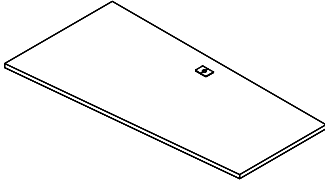

Wedge Worksurface, Left

Model#	(L)	(B)	(E)	(W)	Price
APWT2060 24L	60"	24"	20"	60"	\$294
* APWT2066 24L	66"	24"	20"	66"	\$315
* APWT2072 24L	72"	24"	20"	72"	\$331
APWT2460 30L	60"	30"	24"	60"	\$320
* APWT2466 30L	66"	30"	24"	66"	\$341
* APWT2472 30L	72"	30"	24"	72"	\$362

One silver square grommet (top center) standard. 3" clear from approach.

See external stabilizer bar selection guide on page 174.

* 2 stabilizer bars are required on 66" & 72" wide worksurfaces when supporting with left & right Double post leg, D-legs or T-legs

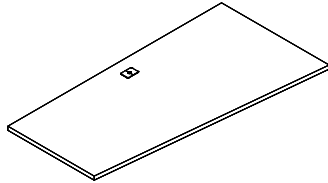

Wedge Worksurface, Right

Model#	(L)	(B)	(E)	(W)	Price
APWT2060 24R	60"	24"	20"	60"	\$294
* APWT2066 24R	66"	24"	20"	66"	\$315
* APWT2072 24R	72"	24"	20"	72"	\$331
APWT2460 30R	60"	30"	24"	60"	\$320
* APWT2466 30R	66"	30"	24"	66"	\$341
* APWT2472 30R	72"	30"	24"	72"	\$362

One silver square grommet (top center) standard. 3" clear from approach.

See external stabilizer bar selection guide on page 174.

* 2 stabilizer bars are required on 66" & 72" wide worksurfaces when supporting with left & right Double post leg, D-legs or T-legs

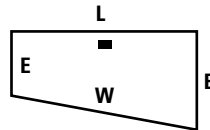

Apex Series



Worksurfaces

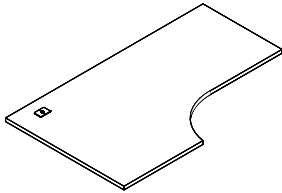

Extended Compu-Corner Worksurface, Left Return

Model#	(L)	(B)	(E)	(K)	(R)	(W)	Price
APET243660L	60"	36"	24"	21"	24"	22"	\$368
* APET243666L	66"	36"	24"	21"	24"	24"	\$391
* APET243672L	72"	36"	24"	21"	24"	30"	\$404
APET244260L	60"	42"	24"	24"	24"	21"	\$394
* APET244266L	66"	42"	24"	24"	24"	27"	\$417
* APET244272L	72"	42"	24"	24"	24"	33"	\$431

One silver square grommet (top corner) standard. 3" clear from approach.
See external stabilizer bar selection guide on page 174.

* 2 stabilizer bars are required on 66" & 72" wide worksurfaces when supporting with left & right Double post leg, D-legs or T-legs

Extended Compu-Corner Worksurface, Right Return

Model#	(L)	(B)	(E)	(K)	(R)	(W)	Price
APET243660R	60"	36"	24"	21"	24"	22"	\$368
* APET243666R	66"	36"	24"	21"	24"	24"	\$391
* APET243672R	72"	36"	24"	21"	24"	30"	\$404
APET244260R	60"	42"	24"	24"	24"	21"	\$394
* APET244266R	66"	42"	24"	24"	24"	27"	\$417
* APET244272R	72"	42"	24"	24"	24"	33"	\$431

One silver square grommet (top corner) standard. 3" clear from approach.
See external stabilizer bar selection guide on page 174.

* 2 stabilizer bars are required on 66" & 72" wide worksurfaces when supporting with left & right Double post leg, D-legs or T-legs

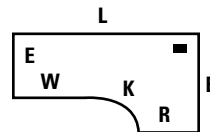

Compu-Corner Angle Worksurface, Left

Model#	(L)	(B)	(E)	(K)	(W)	Price
APAT2472L	72"	24"	20"	48"	15"	\$441
APAT3072L	72"	30"	20"	48"	15"	\$473

One silver square grommet (top center) standard. 3" clear from approach.
See external stabilizer bar selection guide on page 174.

* 2 stabilizer bars are required when supporting with left & right Double post leg, D-legs or T-legs

Compu-Corner Angle Worksurface, Right

Model#	(L)	(B)	(E)	(K)	(W)	Price
APAT2472R	72"	24"	20"	48"	15"	\$441
APAT3072R	72"	30"	20"	48"	15"	\$473

One silver square grommet (top center) standard. 3" clear from approach.
See external stabilizer bar selection guide on page 174.

* 2 stabilizer bars are required when supporting with left & right Double post leg, D-legs or T-legs

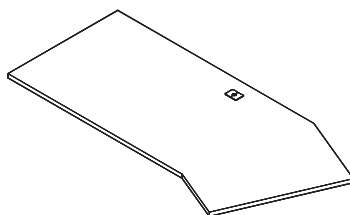
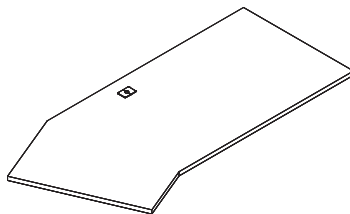
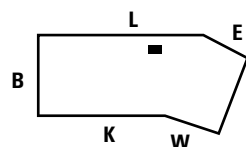



Apex Series

Worksurfaces

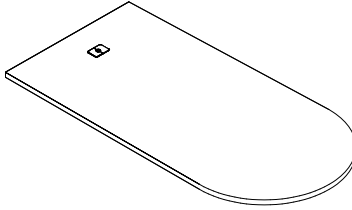

Bullet Worksurface, Left

Model#	Depth	Width	Height	Price
APBD3060L	30"	60"	1"	\$368
* APBD3066L	30"	66"	1"	\$389
* APBD3072L	30"	72"	1"	\$404
* APBD3672L	36"	72"	1"	\$436

One silver square grommet (top left center) standard. 7" clear from straight edge.
See external stabilizer bar selection guide on page 174.

* 2 stabilizer bars are required on 66" & 72" wide worksurfaces when supporting with left & right Double post leg, D-legs or T-legs

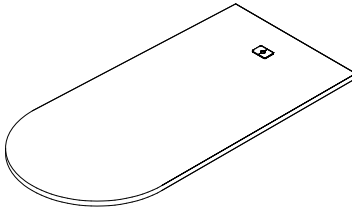

Bullet Worksurface, Right

Model#	Depth	Width	Height	Price
APBD3060R	30"	60"	1"	\$368
* APBD3066R	30"	66"	1"	\$389
* APBD3072R	30"	72"	1"	\$404
* APBD3672R	36"	72"	1"	\$436

One silver square grommet (top right center) standard. 7" clear from straight edge.
See external stabilizer bar selection guide on page 174.

* 2 stabilizer bars are required on 66" & 72" wide worksurfaces when supporting with left & right Double post leg, D-legs or T-legs

Two Rectangular Worksurfaces for Shared Supports

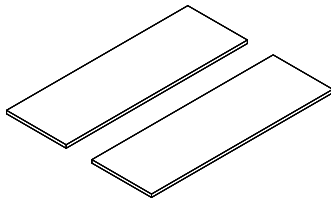

Model#	Depth	Width	Height	Price
APRECH4848	48"	48"	1"	\$420
APRECH4860	48"	60"	1"	\$557
APRECH4866	48"	66"	1"	\$594
APRECH4872	48"	72"	1"	\$620
APRECH6048	60"	48"	1"	\$460
APRECH6060	60"	60"	1"	\$609
APRECH6066	60"	66"	1"	\$662
APRECH6072	60"	66"	1"	\$693

* Quantity of two external stabilizers are required on tops of 54" or greater.
See external stabilizer bar selection guide on page 174.

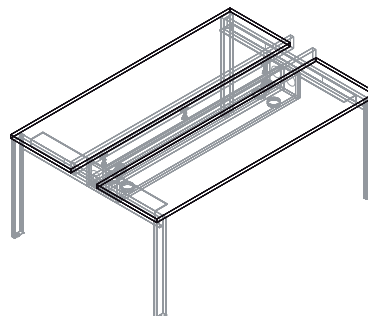

Apex Series



Worksurfaces

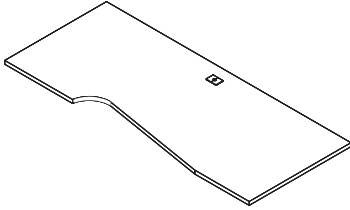

Compu-Corner Saddle Worksurface, Left Return

Model#	(L)	(B)	(K)	(R)	(W)	Price
APST247220L	72"	24"	36"	20"	16"	\$415
APST247224L	72"	24"	32"	24"	16"	\$420
APST307220L	72"	30"	36"	20"	16"	\$441
APST307224L	72"	30"	32"	24"	16"	\$467

One silver square grommet (top center) standard. 3" clear from approach.

See external stabilizer bar selection guide on page 174.

* 2 stabilizer bars are required on 66" & 72" wide worksurfaces when supporting with left & right Double post leg, D-legs or T-legs

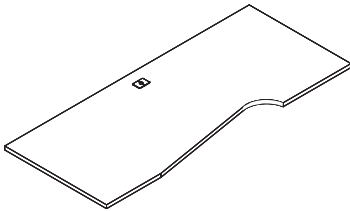

Compu-Corner Saddle Worksurface, Right Return

Model#	(L)	(B)	(K)	(R)	(W)	Price
APST247220R	72"	24"	36"	20"	16"	\$415
APST247224R	72"	24"	32"	24"	16"	\$420
APST307220R	72"	30"	36"	20"	16"	\$441
APST307224R	72"	30"	32"	24"	16"	\$467

One silver square grommet (top center) standard. 3" clear from approach.

See external stabilizer bar selection guide on page 174.

* 2 stabilizer bars are required on 66" & 72" wide worksurfaces when supporting with left & right Double post leg, D-legs or T-legs

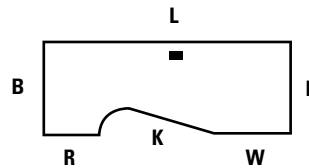



Apex Series

Support Pedestals

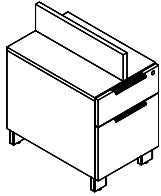

Supporting Box/File (28" high, Locking)

Model#	Depth	Width	Height	Price
APPED A20 BF	20"	16"	28"	\$920
APPED A24 BF	24"	16"	28"	\$940
APPED A30 BF	30"	16"	28"	\$965

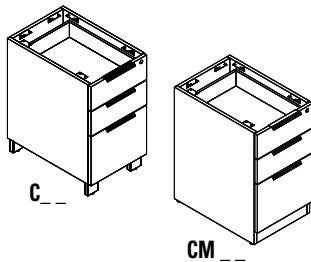

Supporting Box/Box/File (28" high, Locking, No Top)

Model#	Depth	Width	Height	Price
APPED C20 BBF	20"	16"	28"	\$984
APPED C24 BBF	24"	16"	28"	\$990
APPED C30 BBF	30"	16"	28"	\$1,015
APPED CM20 BBF	20"	16"	28"	\$645
APPED CM24 BBF	24"	16"	28"	\$665
APPED CM30 BBF	30"	16"	28"	\$695

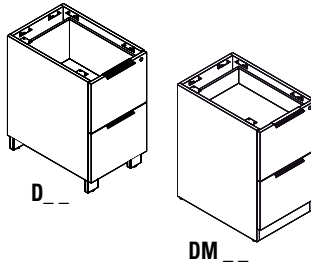

Supporting File/File (28" high, Locking, No Top)

Model#	Depth	Width	Height	Price
APPED D20 FF	20"	16"	28"	\$930
APPED D24 FF	24"	16"	28"	\$950
APPED D30 FF	30"	16"	28"	\$975
APPED DM20 BBF	20"	16"	28"	\$625
APPED DM24 BBF	24"	16"	28"	\$645
APPED DM30 BBF	30"	16"	28"	\$675

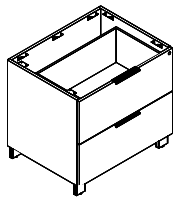

Supporting Lateral File (28" high, Locking, No Top)

Model#	Depth	Width	Height	Price
APPED LF2031	20"	31"	28"	\$1,145
APPED LF2036	20"	36"	28"	\$1,170
APPED LF2431	24"	31"	28"	\$1,180
APPED LF2436	24"	36"	28"	\$1,205

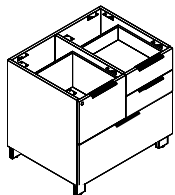

Supporting Personal Lateral File (28" high, Locking, No Top)

Model#	Depth	Width	Height	Price
APPED PLF2031	20"	31"	28"	\$1,250
APPED PLF2431	24"	31"	28"	\$1,280

* Box storage does not lock

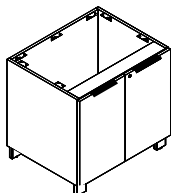

Supporting Hinged Door Cabinet (28" high, Locking, No Top)

Model#	Depth	Width	Height	Price
APPED HDC2030	20"	30"	28"	\$1,015
APPED HDC2036	20"	36"	28"	\$1,025
APPED HDC2430	24"	30"	28"	\$1,035
APPED HDC2436	24"	36"	28"	\$1,050

* One adjustable shelf

Apex Series



Worksurface Supports

External Stabilizer Bar Specification Guide

Worksurface Width

SUPPORT 1	SUPPORT 2	72"	66"	60"	54"
D-LEG	D-LEG	(2) APSB72	(2) APSB66	APSB60	APSB54
D-LEG	T-LEG	(2) APSB72	(2) APSB66	APSB60	APSB54
D-LEG	PEDESTAL (BBF or FF)	APSB60	APSB54	N/A	N/A
D-LEG	LAT/PLF/HDC	N/A	N/A	N/A	N/A
T-LEG	T-LEG	APSB60	APSB54	N/A	N/A
T-LEG	PEDESTAL	APSB54	N/A	N/A	N/A
T-LEG	LAT/PLF/HDC	N/A	N/A	N/A	N/A
PEDESTAL	PEDESTAL	APSB54	N/A	N/A	N/A
PEDESTAL	LAT/PLF/HDC	N/A	N/A	N/A	N/A

NOTE: 2 stabilizer bars are required on 66" & 72" wide worksurfaces when supporting with left & right Double post leg, D-legs or T-legs. If a modesty panel (TFM or HPL) is being specified only one stabilizer is required.

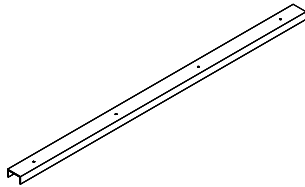

External Stabilizer Bar

Model#	Depth	Width	Height	Price
APSB54	2"	38"	1"	\$60
APSB60	2"	44"	1"	\$65
APSB66	2"	50"	1"	\$70
APSB72	2"	56"	1"	\$75

* Reference stabilizer bar specification guide to determine stabilizer bar required. Stabilizer bars are recommended to be on site 6" clear from approach side with #8 x 1" wood screws.

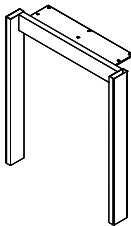

Double Post Leg (28"H, Silver Finish)

Model#	Depth	Width	Height	Price
APODPL20	20"	3"	28"	\$265
APODPL24	24"	3"	28"	\$285
APODPL30	30"	3"	28"	\$305
APODPL48	48"	3"	28"	\$375
APODPL60	60"	3"	28"	\$400

NOTE: 2 stabilizer bars are required on 66" & 72" wide worksurfaces when supporting with left & right double post leg.

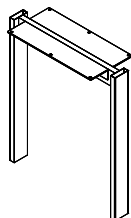

Shared Double Post Leg (28"H, Silver Finish)

Model#	Depth	Width	Height	Price
APDPML20	20"	3"	28"	\$320
APDPML24	24"	3"	28"	\$355
APDPML30	30"	3"	28"	\$385

* Use to support two worksurfaces.



Apex Series

Worksurface Supports

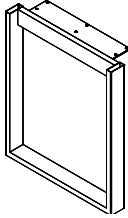

D-Leg (28"H, Silver Finish)

Model#	Depth	Width	Height	Price
APODL20	20"	3"	28"	\$325
APODL24	24"	3"	28"	\$350
APODL30	30"	3"	28"	\$370
APODL48	48"	3"	28"	\$435
APODL60	60"	3"	28"	\$480

NOTE: 2 stabilizer bars are required on 66" & 72" wide worksurfaces when supporting with left & right D-leg.

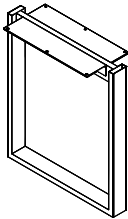

Shared D-Leg (28"H, Silver Finish)

Model#	Depth	Width	Height	Price
APMDL20	20"	3"	28"	\$400
APMDL24	24"	3"	28"	\$415
APMDL30	30"	3"	28"	\$445

* Use to support two worksurfaces.

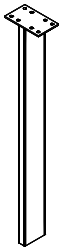

Single Post (28"H, Silver Finish)

Model#	Depth	Width	Height	Price
APSP28	1"	3"	28"	\$115

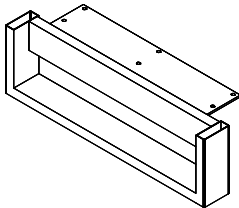

Short D-Leg (6"H, Silver Finish)

Model#	Depth	Width	Height	Price
APOSDL20	20"	3"	6"	\$350
APOSDL24	24"	3"	6"	\$360
APOSDL30	30"	3"	6"	\$390

* Supports worksurface below tops and above low credenza

Apex Series



Worksurface Supports

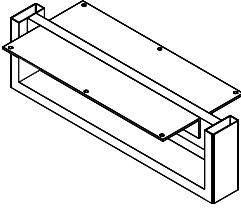

Short D-Leg Shared (6"H, Silver Finish)

Model#	Depth	Width	Height	Price
APMSDL20	20"	3"	6"	\$333
APMSDL24	24"	3"	6"	\$350
APMSDL30	30"	3"	6"	\$385

* Use to support two worksurfaces above low credenzas.

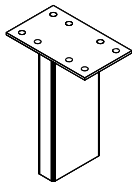

Low Post Leg (6"H, Silver Finish)

Model#	Depth	Width	Height	Price
APSPL6	1"	3"	6"	\$50

* Supports worksurface below tops and above low credenza

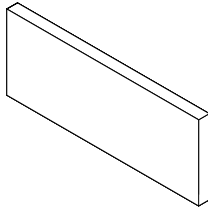

Low Credenza TFM Support

Model#	Depth	Width	Height	Price
APSLEG20	20"	1"	6"	\$70
APSLEG24	24"	1"	6"	\$75
APSLEG30	30"	1"	6"	\$80

* (1) Silver grommet . Pin and cam connection to worksurface underside.
Silver TFM with silver trim standard.

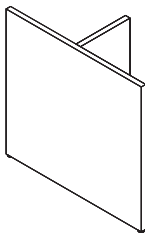

T-Leg

Model#	Depth	Width	Height	Price
APTLEG20	20"	13"	28"	\$120
APTLEG24	24"	13"	28"	\$130
APTLEG30	30"	13"	28"	\$135

NOTE: 2 stabilizer bars are required on 66" & 72" wide worksurfaces when supporting with left & right T-leg.



Apex Series

Privacy Screens

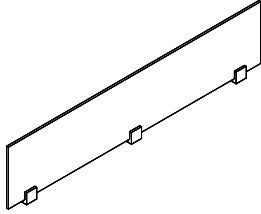

Top Frosted Acrylic Privacy Screen (3/8" thick acrylic)

Model#	Depth	Width	Height	Price
APPSU24	1"	17"	12"	\$165
APPSU30	1"	23"	12"	\$205
APPSU36	1"	29"	12"	\$267
APPSU42	1"	35"	12"	\$294
APPSU48	1"	41"	12"	\$360
APPSU54	1"	47"	12"	\$515
APPSU60	1"	53"	12"	\$520
APPSU66	1"	59"	12"	\$525
APPSU72	1"	65"	12"	\$530

* Privacy screens APPSU24 thru APPSU48 include two mounting clips.

Frosted Acrylic Modesty (3/8" thick acrylic)

Model#	Depth	Width	Height	Price
APPSL24	1"	17"	12"	\$165
APPSL30	1"	23"	12"	\$205
APPSL36	1"	29"	12"	\$267
APPSL42	1"	35"	12"	\$294
APPSL48	1"	41"	12"	\$360
APPSL54	1"	47"	12"	\$515
APPSL60	1"	53"	12"	\$520
APPSL66	1"	59"	12"	\$525
APPSL72	1"	65"	12"	\$530

* Modesties APPSL24 thru APPSL48 include two mounting clips.

TFM Modesty (3/4" thick)

Model#	Depth	Width	Height	Price
APPSLW24	4"	17"	12"	\$78
APPSLW30	4"	23"	12"	\$78
APPSLW36	4"	29"	12"	\$90
APPSLW42	4"	35"	12"	\$90
APPSLW48	4"	41"	12"	\$101
APPSLW54	4"	47"	12"	\$101
APPSLW60	4"	53"	12"	\$114
APPSLW66	4"	59"	12"	\$122
APPSLW72	4"	65"	12"	\$122

* 3/4" thick TFM. Modesties APPSLW24 thru APPSLW48 include two vertical supports.

HPL Modesty (3/4" thick)

Model#	Depth	Width	Height	Price
APPSLHP24	4"	17"	12"	\$114
APPSLHP30	4"	23"	12"	\$114
APPSLHP36	4"	29"	12"	\$138
APPSLHP42	4"	35"	12"	\$138
APPSLHP48	4"	41"	12"	\$168
APPSLHP54	4"	47"	12"	\$168
APPSLHP60	4"	53"	12"	\$204
APPSLHP66	4"	59"	12"	\$222
APPSLHP72	4"	65"	12"	\$222

* 3/4" thick HPL. Modesties APPSLHP24 thru APPSLHP48 include two vertical supports.

Modesty Panels

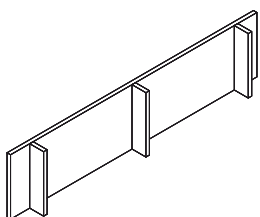
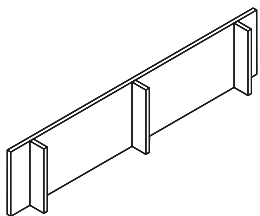
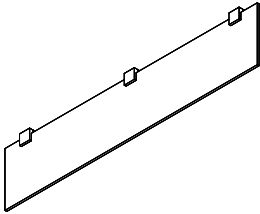

Apex Series



Low Credenzas

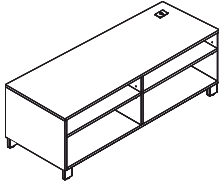

Left Open Credenza

Model#	Depth	Width	Height	Price
APDO2048L	20"	48"	22"	\$1,090
APDO2060L	20"	60"	22"	\$1,275
APDO2066L	20"	66"	22"	\$1,285
APDO2072L	20"	72"	22"	\$1,320
APDO2448L	24"	48"	22"	\$1,150
APDO2460L	24"	60"	22"	\$1,320
APDO2466L	24"	66"	22"	\$1,350
APDO2472L	24"	72"	22"	\$1,390

* Standard silver square grommet on top & modesty. 2-adjustable shelves.

Right Open Credenza

Model#	Depth	Width	Height	Price
APDO2048R	20"	48"	22"	\$1,090
APDO2060R	20"	60"	22"	\$1,275
APDO2066R	20"	66"	22"	\$1,285
APDO2072R	20"	72"	22"	\$1,320
APDO2448R	24"	48"	22"	\$1,150
APDO2460R	24"	60"	22"	\$1,320
APDO2466R	24"	66"	22"	\$1,350
APDO2472R	24"	72"	22"	\$1,390

* Standard silver square grommet on top & modesty. 2-adjustable shelves.

Left Single Box/Lateral Credenza (Locking)

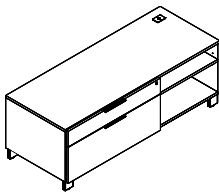

Model#	Depth	Width	Height	Price
APSBL2048L	20"	48"	22"	\$1,455
APSBL2060L	20"	60"	22"	\$1,520
APSBL2066L	20"	66"	22"	\$1,550
APSBL2072L	20"	72"	22"	\$1,580
APSBL2448L	24"	48"	22"	\$1,510
APSBL2460L	24"	60"	22"	\$1,600
APSBL2466L	24"	66"	22"	\$1,650
APSBL2472L	24"	72"	22"	\$1,700

* Standard silver square grommet on top & modesty. 1-adjustable shelf.
31" w Box/Lateral file on 48" w credenzas only.

Right Single Box/Lateral Credenza (Locking)

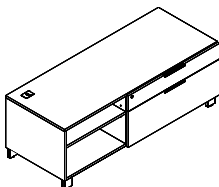

Model#	Depth	Width	Height	Price
APSBL2048R	20"	48"	22"	\$1,455
APSBL2060R	20"	60"	22"	\$1,520
APSBL2066R	20"	66"	22"	\$1,550
APSBL2072R	20"	72"	22"	\$1,580
APSBL2448R	24"	48"	22"	\$1,510
APSBL2460R	24"	60"	22"	\$1,600
APSBL2466R	24"	66"	22"	\$1,650
APSBL2472R	24"	72"	22"	\$1,700

* Standard silver square grommet on top & modesty. 1-adjustable shelf.
31" w Box/Lateral file on 48" w credenzas only.



Apex Series

Low Credenzas

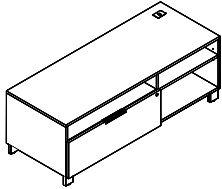

Left Single Lateral Credenza (Locking)

Model#	Depth	Width	Height	Price
APSL02048L	20"	48"	22"	\$1,375
APSL02060L	20"	60"	22"	\$1,535
APSL02066L	20"	66"	22"	\$1,565
APSL02072L	20"	72"	22"	\$1,600
APSL02448L	24"	48"	22"	\$1,425
APSL02460L	24"	60"	22"	\$1,600
APSL02466L	24"	66"	22"	\$1,640
APSL02472L	24"	72"	22"	\$1,675

* Standard silver square grommet on top & modesty. 1-adjustable shelf.
31"w Box/Lateral file on 48"w credenzas only.

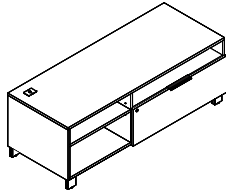

Right Single Lateral Credenza (Locking)

Model#	Depth	Width	Height	Price
APSL02048R	20"	48"	22"	\$1,375
APSL02060R	20"	60"	22"	\$1,535
APSL02066R	20"	66"	22"	\$1,565
APSL02072R	20"	72"	22"	\$1,600
APSL02448R	24"	48"	22"	\$1,425
APSL02460R	24"	60"	22"	\$1,600
APSL02466R	24"	66"	22"	\$1,640
APSL02472R	24"	72"	22"	\$1,675

* Standard silver square grommet on top & modesty. 1-adjustable shelf.
31"w Box/Lateral file on 48"w credenzas only.

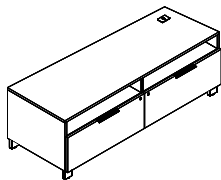

Left Double Lateral Credenza (Locking)

Model#	Depth	Width	Height	Price
APDOL2061L	20"	61"	22"	\$1,700
APDOL2072L	20"	72"	22"	\$1,750
APDOL2461L	24"	61"	22"	\$1,795
APDOL2472L	24"	72"	22"	\$1,830

* Standard silver square grommet on top & modesty.

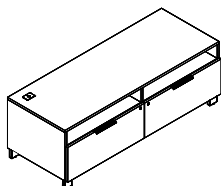

Right Double Lateral Credenza (Locking)

Model#	Depth	Width	Height	Price
APDOL2061R	20"	61"	22"	\$1,700
APDOL2072R	20"	72"	22"	\$1,750
APDOL2461R	24"	61"	22"	\$1,795
APDOL2472R	24"	72"	22"	\$1,830

* Standard silver square grommet on top & modesty.

Apex Series



Freestanding Storage

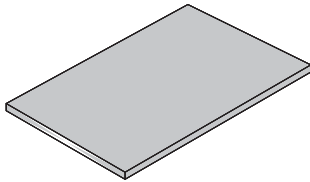

Cushion (Standard fabrics)

Model#	Depth	Width	Height	Price
APCUH2016	20"	16"	1"	\$150
APCUH2416	24"	16"	1"	\$160
APCUH2030	20"	30"	1"	\$168
APCUH2430	24"	30"	1"	\$178

16"w for pedestal, 30"w for credenza

* For Cosmopolitan & underground fabrics add 25%.

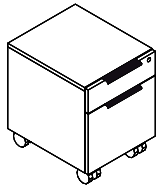

Mobile Pedestal (Box, File, Locking)

Model#	Depth	Width	Height	Price
APPEDAX20BF	20"	16"	22"	\$785
APPEDAX24BF	24"	16"	22"	\$805

* Seating weight capacity 175lbs.

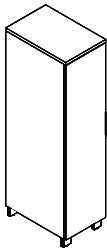

Left Single Storage Cabinet

Model#	Depth	Width	Height	# of Shelves	Price
APSTS2054L	20"	16"	54"	2	\$1,235
APSTS2065L	20"	16"	65"	3	\$1,300
APSTS2454L	24"	16"	54"	2	\$1,295
APSTS2465L	24"	16"	65"	3	\$1,375

* Optional lock available, add MMFL...\$65.

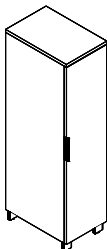

Right Single Storage Cabinet

Model#	Depth	Width	Height	# of Shelves	Price
APSTS2054R	20"	16"	54"	2	\$1,235
APSTS2065R	20"	16"	65"	3	\$1,300
APSTS2454R	24"	16"	54"	2	\$1,295
APSTS2465R	24"	16"	65"	3	\$1,375

* Optional lock available, add MMFL...\$65.

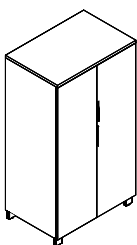

Double Storage Cabinet

Model#	Depth	Width	Height	# of Shelves	Price
APDST2054	20"	36"	54"	2	\$1,500
APDST2065*	20"	36"	65"	3	\$1,625
APDST2454	24"	36"	54"	2	\$1,565
APDST2465*	24"	36"	65"	3	\$1,690

* Optional lock available, add MMFL...\$65.



Apex Series

Freestanding Storage

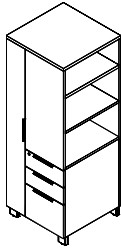

Left Personal Bookcase Storage (Box, Box, File, Locking)

Model#	Depth	Width	Height	# of Shelves	Price
APPBSC2054L	20"	24"	54"	3	\$1,440
APPBSC2065L	20"	24"	65"	5	\$1,495
APPBSC2454L	24"	24"	54"	3	\$1,460
APPBSC2465L	24"	24"	65"	5	\$1,525

* No coat rack. Adjustable shelves on long compartment. 2-adjustable shelves on 54"H, 3-adjustable shelves on 65". Optional face lock for hinged door available, add MMFL...\$65.

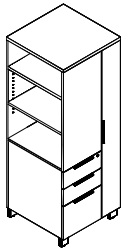

Right Personal Bookcase Storage (Box, Box, File, Locking)

Model#	Depth	Width	Height	# of Shelves	Price
APPBSC2054R	20"	24"	54"	3	\$1,440
APPBSC2065R	20"	24"	65"	5	\$1,495
APPBSC2454R	24"	24"	54"	3	\$1,460
APPBSC2465R	24"	24"	65"	5	\$1,525

* No coat rack. Adjustable shelves on long compartment. 2-adjustable shelves on 54"H, 3-adjustable shelves on 65". Optional face lock for hinged door available, add MMFL...\$65.

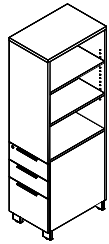

Left Single Personal Cabinet (Box/Box/File, Locking)

Model#	Depth	Width	Height	# of Shelves	Price
APBCPS2054L	20"	16"	54"	1	\$1,355
APBCPS2065L	20"	16"	65"	2	\$1,395
APBCPS2454L	24"	16"	54"	1	\$1,425
APBCPS2465L	24"	16"	65"	2	\$1,470

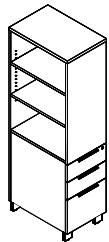

Right Single Personal Cabinet (Box/Box/File, Locking)

Model#	Depth	Width	Height	# of Shelves	Price
APBCPS2054R	20"	16"	54"	1	\$1,355
APBCPS2065R	20"	16"	65"	2	\$1,395
APBCPS2454R	24"	16"	54"	1	\$1,425
APBCPS2465R	24"	16"	65"	2	\$1,470

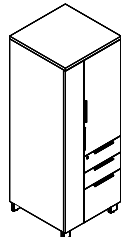

Left Personal Wardrobe Cabinet (Box/Box/File, Locking)

Model#	Depth	Width	Height	# of Shelves	Price
APWCP2454L	24"	24"	54"	1	\$1,485
APWCP2465L	24"	24"	65"	2	\$1,555

* Coat rack bar in long compartment included.
Optional face lock for hinged door available (two required), add MMFL...\$65/ea.

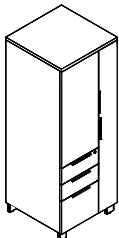

Right Personal Wardrobe Cabinet (Box/Box/File, Locking)

Model#	Depth	Width	Height	# of Shelves	Price
APWCP2454R	24"	24"	54"	1	\$1,485
APWCP2465R	24"	24"	65"	2	\$1,555

* Coat rack bar in long compartment included.
Optional face lock for hinged door available (two required), add MMFL...\$65/ea.

Apex Series



Freestanding Storage & Bookcase

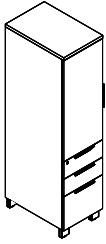

Left Single Storage Cabinet (Box/Box/File, Locking)

Model#	Depth	Width	Height	# of Shelves	Price
APBCV2054L	20"	16"	54"	1	\$1,490
APBCV2065L	20"	16"	65"	2	\$1,550
APBCV2454L	24"	16"	54"	1	\$1,555
APBCV2465L	24"	16"	65"	2	\$1,600

* Optional face lock for hinged door available, add MMFL...\$65/ea.

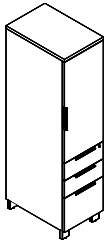

Right Single Storage Cabinet (Box/Box/File, Locking)

Model#	Depth	Width	Height	# of Shelves	Price
APBCV2054R	20"	16"	54"	1	\$1,490
APBCV2065R	20"	16"	65"	2	\$1,550
APBCV2454R	24"	16"	54"	1	\$1,555
APBCV2465R	24"	16"	65"	2	\$1,600

* Optional face lock for hinged door available, add MMFL...\$65/ea.

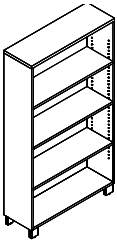

Bookcase

Model#	Depth	Width	Height	# of Shelves	Price
APBC30	12"	36"	29"	1	\$552
APBC54	12"	36"	54"	2	\$707
APBC65	12"	36"	65"	3	\$832

Overhead Storage

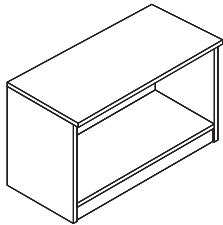

Wall Mount Overhead, No Doors

Model#	Depth	Width	Height	Price
APCFOHO30	14 3/4"	30"	18 1/2"	\$475
APCFOHO36	14 3/4"	36"	18 1/2"	\$565
APCFOHO42	14 3/4"	42"	18 1/2"	\$655
APCFOHO48	14 3/4"	48"	18 1/2"	\$695

* Wall mount overhead storage includes fascia. 35lb. weight capacity. Requires professional installation and must be mounted to wall stud. Optional tasklight APTSKLTX24...add \$153.

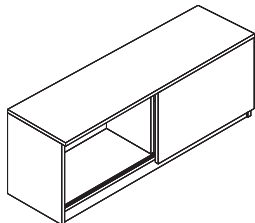

Wall Mount Overhead with One Sliding Door

Model#	Depth	Width	Height	Price
APCFOHS30	14 3/4"	30"	18 1/2"	\$660
APCFOHS36	14 3/4"	36"	18 1/2"	\$750
APCFOHS42	14 3/4"	42"	18 1/2"	\$840
APCFOHS48	14 3/4"	48"	18 1/2"	\$895

* No lock available. Wall mount overhead storage includes fascia. 35lb. weight capacity. Requires professional installation and must be mounted to wall stud. Optional tasklight APTSKLTX24...add \$153.

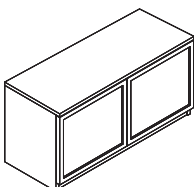

Wall Mount Overhead with Frosted Glass Doors

Model#	Depth	Width	Height	Price
APCFOHG36	14 3/4"	36"	18 1/2"	\$860

* No lock available. Wall mount overhead storage includes fascia. 35lb. weight capacity. Requires professional installation and must be mounted to wall stud. Optional tasklight APTSKLTX24...add \$153.



Apex Series

Overhead Storage

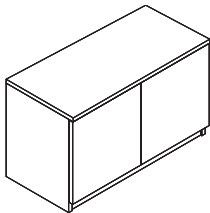

Wall Mount Overhead with Laminate Hinged Doors

Model#	Depth	Width	Height	# of Doors	Price
APCF0HD30	14 3/4"	30"	18 1/2"	2	\$695
APCF0HD36	14 3/4"	36"	18 1/2"	2	\$715
APCF0HD42	14 3/4"	42"	18 1/2"	2	\$820
APCF0HD48	14 3/4"	48"	18 1/2"	4	\$845

* Wall mount overhead storage includes fascia. Requires professional installation and must be mounted to wall stud. Optional face lock available (two required on 42" & 48" wide) add...\$65 each. 35lb. weight capacity.

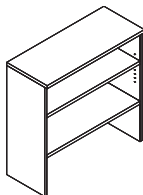

Bookcase Hutch

Model#	Depth	Width	Height	Price
APBCH36	14"	36"	36"	\$395

1-fixed shelf and 1-adjustable.

Hutches

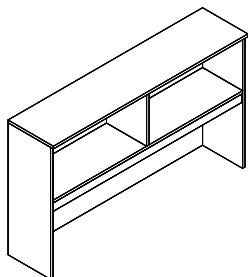

Hutch, No Doors

Model#	Depth	Width	Height	Price
APH36ND	14"	36"	36"	\$525
APH42ND	14"	42"	36"	\$585
APH48ND	14"	48"	36"	\$645
APH54ND	14"	54"	36"	\$675
APH60ND	14"	60"	36"	\$705
APH66ND	14"	66"	36"	\$745
APH72ND	14"	72"	36"	\$785

* Hutch includes fascia. Optional tasklight APTSKLTX24...add \$153.

Hutch with One Sliding Door

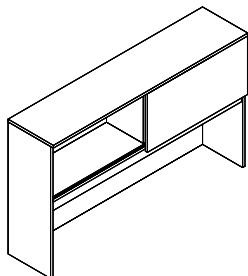

Model#	Depth	Width	Height	Price
APH36SD	14"	36"	36"	\$755
APH42SD	14"	42"	36"	\$810
APH48SD	14"	48"	36"	\$865
APH54SD	14"	54"	36"	\$920
APH60SD	14"	60"	36"	\$975
APH72SD	14"	72"	36"	\$1,030

* No lock available. Hutch includes fascia. Optional tasklight APTSKLTX24...add \$153.

Hutch with Laminate Hinged Doors

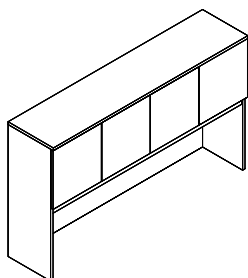

Model#	Depth	Width	Height	# of Doors	Price
APH36WD	14"	36"	36"	2	\$675
APH42WD	14"	42"	36"	2	\$760
APH48WD	14"	48"	36"	4	\$855
APH54WD	14"	54"	36"	4	\$895
APH60WD	14"	60"	36"	4	\$934
APH72WD	14"	72"	36"	4	\$1,031

* Hutch includes fascia. Optional tasklight APTSKLTX24...add \$153.
Optional face locks available (two locks required, except on 36") MMFL...add \$65 each.

Apex Series



Hutches

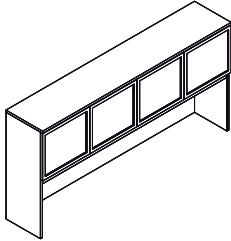

Hutch with Frosted Glass Doors

Model#	Depth	Width	Height	# of Doors	Price
APH36WG	14"	36"	36"	2	\$865
APH72WG	14"	72"	36"	4	\$1,468

* No lock available. Hutch includes fascia. Optional tasklight APTSKLTX24...add \$153.

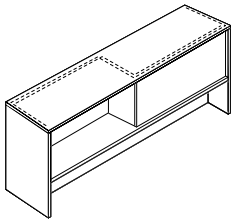

Two-sided Hutch with Open Shared Bins

Model#	Depth	Width	Height	Price
APHSB60	14"	60"	25"	\$765
APHSB66	14"	66"	25"	\$795
APHSB72	14"	72"	25"	\$825

Optional tackboards available for lower and upper section.

Tackboards

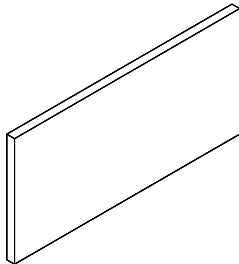

Hutch Tackboard (Standard)

Model#	Depth	Width	Height	Price
APTKBD1936	1"	34"	19"	\$280
APTKBD1942	1"	40"	19"	\$350
APTKBD1948	1"	46"	19"	\$370
APTKBD1954	1"	52"	19"	\$380
APTKBD1960	1"	58"	19"	\$430
APTKBD1966	1"	64"	19"	\$460
APTKBD1972	1"	70"	19"	\$490

For Cosmopolitan & underground fabrics add 25%.

Tackboard (Lower) for Two Sided Hutch

Model#	Depth	Width	Height	Price
APTKBD0860	1"	58"	8"	\$285
APTKBD0866	1"	64"	8"	\$305
APTKBD0872	1"	70"	8"	\$330

Fits APHSB hutch only. Two lower tackboards required on two sided hutch.
For Cosmopolitan & underground fabrics add 25%.

Tackboard (Upper) for Two Sided Hutch

Model#	Depth	Width	Height	Price
APTKBD1530	1"	29"	15"	\$265
APTKBD1533	1"	32"	15"	\$280
APTKBD1536	1"	35"	15"	\$300

Fits APHSB hutch only. Two upper tackboards required on two sided hutch.
For Cosmopolitan & underground fabrics add 25%.

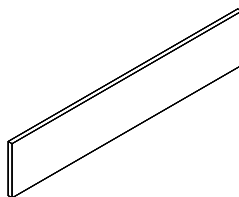



Apex Series

Bases

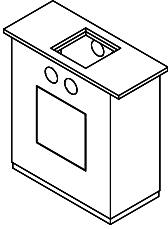

Square Panel Base (Hollow w/Access Door)

Model#	Depth	Width	Height	Price
APASQWD1224	12"	24"	28"	\$840
APASQWD1230	12"	30"	28"	\$1,025

* Four grommet cutouts standard.
To be used with shared worksurfaces and wire management troughs.

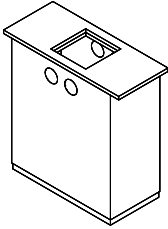

Square Panel Base (No Door)

Model#	Depth	Width	Height	Price
APASQND1224	12"	24"	28"	\$510
APASQND1230	12"	30"	28"	\$570

Four grommet cutouts standard.
To be used with shared worksurfaces and wire management troughs.

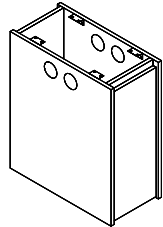

Square Panel Base (Hollow w/End Access Door)

Model#	Depth	Width	Height	Price
APLEGM1224	12"	24"	28"	\$380
APLEGM1230	12"	30"	28"	\$465

Four grommet cutouts standard.
To be used with shared worksurfaces and wire management troughs.

Apex Series



Wire Management

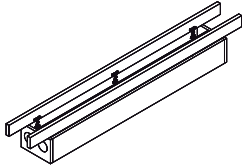

Middle Wire Management Trough w/Hinged Doors

Model#	Depth	Width	Height	Price
APWMTM48	10"	36"	8"	\$495
APWMTM60	10"	48"	8"	\$590
APWMTM66	10"	54"	8"	\$660
APWMTM72	10"	60"	8"	\$740

* To be used between square panel bases. Grommet holes on left and right side.

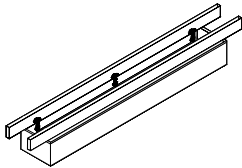

Outer Wire Management Trough w/Hinged Doors

Model#	Depth	Width	Height	Price
APWMT048	10"	35"	8"	\$485
APWMT060	10"	47"	8"	\$580
APWMT066	10"	53"	8"	\$650
APWMT072	10"	59"	8"	\$730

* To be used between one metal support leg and one square panel base. Grommet holes one side only.



Electrical Starter Cable (8-Wire, 4-circuit)

Model#	Depth	Width	Height	Price
APESC72	1"	72"	1"	\$172

* Must be connected to a building electrical supply by licensed electrician. (40) outlets maximum per single feed.



Daisy Chain Electrical Cable

Model#	Depth	Width	Height	Price
APDCE24	1"	24"	1"	\$122
APDCE36	1"	28"	1"	\$139
APDCE48	1"	40"	1"	\$155
APDCE60	1"	52"	1"	\$172
APDCE66	1"	58"	1"	\$185
APDCE72	1"	64"	1"	\$190



Single-sided Power Box (Four Power Outlets)

Model#	Depth	Width	Height	Price
APSSPB4	1 1/4"	9 5/16"	2 1/4"	\$135

* Can be mounted below worksurfaces or in wire management troughs. Includes (1) circuit 1, (1) circuit 2, (1) circuit IG, (1) circuit 4.



Double-sided Power Box (Eight Power Outlets)

Model#	Depth	Width	Height	Price
APSSPB8	2"	8 7/16"	2 1/2"	\$220

Can be mounted below worksurfaces only. Includes (2) circuit 1, (2) circuit 2, (2) circuit IG, (2) circuit 4.



Apex Series

Wire Management

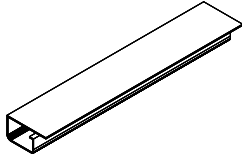

Plastic Wire Management Trough

Model#	Depth	Width	Height	Price
APPWM18	2"	18"	1"	\$17

Finish: Black only. Field installed below worksurface w/#8x1" wood screws (supplied).

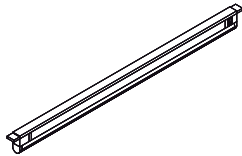

Tasklight

Model#	Depth	Width	Height	Price
APTSKLTX24	7/8"	24 1/2"	1 7/8"	\$153

Finish: Black only.



Worksurface Mounted Power Module (1-Power Outlet, 2-USB)

Model#	Depth	Width	Height	Price
APPWR1GW*	2 1/4"	4 3/4"	2 1/2"	\$440
APPWR1S**	2 1/4"	4 3/4"	2 1/2"	\$440

Field installed above or below worksurface w/hardware (supplied). No cut-out required.

* GW= Glossy White

** S=Silver & Black



Worksurface Mounted Power Module (3-Power Outlets, 2-USB)

Model#	Depth	Width	Height	Price
APPWR3GW*	2 1/4"	7 1/2"	2 1/2"	\$460
APPWR3S**	2 1/4"	7 1/2"	2 1/2"	\$460

Field installed above or below worksurface w/hardware (supplied). No cut-out required.

* GW= Glossy White

** S=Silver & Black



Vertibra Wire Management

Model#	Depth	Width	Height	Price
APVMT28	4"	4"	28"	\$160

* Wire management from floor to underside of work surface (Field installed).











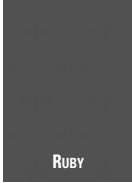



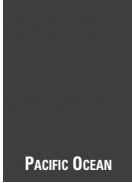









Finish: Silver.



Apex Series

NOTE: IMAGES ON THIS PAGE CAN BE VIEWED IN COLOR BY GOING TO: WWW.MAVERICKDESK.COM/SERIES/APEX...PG.33 OF PRICE LIST

MODESTY OPTIONS

 SATIN STAINLESS	 RUBY	 MAPLE
		 MEDIUM OAK
		 OILED CHERRY
 TANGERINE	 PACIFIC OCEAN	 COGNAC
		 SEATTLE CHERRY
		 CHESTNUT
 STARRY NIGHT	 MELON	 AFRICAN WALNUT
		 JAVA
		 ESPRESSO
 SEAFOAM	 LILAC	 SPICE WALNUT
		 DRIFTWOOD
		 COLOMBIAN WALNUT
HPL OPTIONS * Upcharges apply		 ASIAN SAND
 FROSTED ACRYLIC * Frosted Acrylic * Upcharges apply		 GRAPHITE NEBULA
		 GREY
		 CHARCOAL
		 BLACK
		 MAJESTIC WHITE

HANDLE

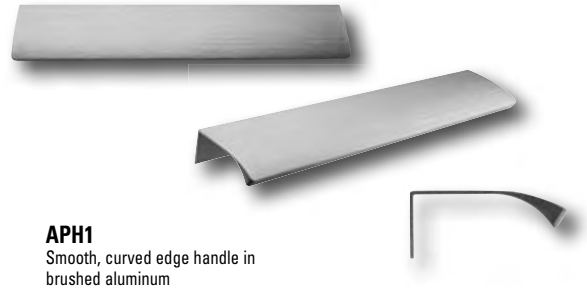

APH1
Smooth, curved edge handle in brushed aluminum

POWER MANAGEMENT



APSSPB4/ APSSPB8
Single sided power box with four power outlets/
Double sided power box with eight power outlets



APESC72
System hardwire electrical starter cable 72"



APDCE
Daisy chain electrical cable



APVMT28
Vertebra Wire Manager



APPWR1
Desktop 1 Power, 2 USB



APPWR3
Desktop 3 Power, 2 USB

PRIVACY SCREEN



APPSU
Top acrylic privacy screen

GROMMET



APGRRECS
Silver Rectangular Grommet

Terms and Conditions

Terms and Conditions

TERMS OF SALE: Orders, sales, and contracts are expressly conditioned on acceptance of our terms, which constitute the complete and exclusive contract between the parties. We object to any additional or different terms proposed by the Buyer. Our failure to specifically object to additional or different terms shall not be deemed a waiver of exclusivity of our terms.

No order or contract shall be effective or binding upon us unless accepted by Maverick in Fairfield, OH. Sales representatives, dealers or agents are not authorized to bind us to any terms additional to or different than the terms and conditions contained herein. Representations made by agents are not part of this contract and do not constitute a warranty unless specifically included herein. This agreement may not be modified except by written agreement signed by an executive officer of Maverick.

PRICES: Prices are F.O.B. in Fairfield, OH. Packing and cartoning charges, taxes, shipping, handling, storage, installation, special cut and other charges will be added to advertised or quoted prices. Price dimensions and specifications shown are subject to change without notice.

ORDERING: Production and/or shipping will not be scheduled until receipt of Buyer's written purchase order. Incomplete orders will not be scheduled for production. Order Acknowledgments are processed when the order is scheduled for production. All literature including, but not limited to, specifications, drawings, weights and dimensions, catalogs, price lists and advertising material, is for illustrative purposes only and shall not be construed as a warranty. The Buyer assumes responsibility for suitability of our products in their final environment unless the designs, drawings, product configurations and order have been specifically approved by Maverick.

Acknowledgements

Orders are acknowledged no later than 24 hours of receipt, or of credit approval. Your acknowledgement is a detailed description of items, prices, items, shipping information and estimated due date. Please check your acknowledgment closely and notify Maverick immediately of any discrepancies.

Payment Terms: Upon establishing approved credit with Maverick, Dealer terms are net 30 days from date of invoice. Unpaid invoices will accrue finance charge of 1.5% per month (18% per annum) if payment is past due. Prior to establishing approved credit, Maverick's terms are 25% deposit at the time the order is entered and the balance due prior to shipment of the product. If dealer demonstrates a history of late payments, Maverick may elect to adjust the Dealer's discount off of the list price.

ORDERING ADDRESS:

Maverick
3158 Production Drive
Fairfield, Ohio 45014
Phone: (800) 543-8249
Fax: (800) 543-8221

PAYMENT ADDRESS:

Maverick Desk
8216 Solution Center
Chicago, IL 60677-8002

Shipping: Delivery shall be F.O.B. our factory, Fairfield, OH. We are authorized, but not required, to arrange shipping by common carrier. Most shipments are made by motor freight or parcel service. Lead times and quote ship dates are estimated and we are not responsible for any losses resulting from delays.

DAMAGE IN TRANSIT: Our obligations are to be deemed fulfilled, delivery complete, and the risk of loss shifted to the Buyer as soon as conforming goods are delivered to a common carrier. All products are thoroughly

inspected and carefully packaged prior to shipment. The Buyer is responsible for inspecting all cartons immediately on arrival and notifying the common carrier of any damage (whether visible or concealed) within seven days after receipt of merchandise. The Buyer assumes responsibility for any claims against the carrier. All cartoning must be kept with damaged materials.

SELLER'S NON PERFORMANCE: We shall not be held responsible for any loss, delay, failure to deliver or damage caused by our inability to obtain labor, materials, fuel or supplies; fire, accidents, floods or adverse weather conditions; strikes, lockouts or other labor disputes; embargoes, governmental acts or requirements; wars, insurrections or riots, or by any other cause beyond reasonable control of ourselves or our suppliers.

Limited Warranty: Maverick warrants to the original retail purchaser that Maverick products will be free from defects in material and workmanship under normal single shift usage for ten (10) years from the original date of purchase.

This warranty is not applicable to end-user customers who use Maverick products for rental purposes and is void for any damage due to misuse, abuse, neglect, accident, improper installation, failure to comply with instructions furnished by Maverick or any repair or alteration performed by anyone other than Maverick or an authorized Maverick dealer. Damage caused by common carrier during shipment is not included in this warranty. THIS WARRANTY IS THE ONLY WARRANTY MADE BY MAVERICK. ALL OTHER WARRANTIES WHETHER EXPRESS OR IMPLIED, INCLUDING IMPLIED WARRANTIES OF MERCHANTABILITY AND FITNESS FOR A PARTICULAR PURPOSE, ARE HEREBY DISCLAIMED.

During this warranty period, if any Maverick product sold subject to this warranty proves to be defective in material and workmanship under normal use, the purchaser must contact an authorized Maverick dealer in writing who will arrange for inspection of such Maverick product by an authorized Maverick representative. The Maverick representative after inspection may cause to have issued a return authorization for such Maverick product. No Maverick product will be accepted for return unless prior authorization is obtained from Maverick. Maverick shall, at its option either (1) repair such product free of charge or (2) replace such Maverick product free of charge. Maverick Desk will pay all shipping charges associated with the authorized return, repair and/or replacement of a defective Maverick product. THIS IS THE EXCLUSIVE REMEDY FOR ANY BREACH OF WARRANTY. IN NO EVENT SHALL MAVERICK BE LIABLE FOR ANY INCIDENTAL, SPECIAL OR CONSEQUENTIAL DAMAGES OF ANY KIND, WHETHER FOR BREACH OF ANY WARRANTY, FOR BREACH OF REPUDIATION OF ANY OTHER TERM OR CONDITION OF SALE FOR NEGLIGENCE, ON THE BASIS OF STRICT LIABILITY, OR OTHERWISE.

CHANGES/CANCELLATIONS: Orders may not be changed or canceled without written consent. Orders for non-standard or modified products may not be canceled. Cancellation or change request must be submitted within three (3) working days after the receipt of Order Acknowledgement, providing the order has not already been put into production. A charge will be incurred if necessary to fully compensate us for all materials ordered, work performed, lost profits, reasonable overhead, and any other expenses resulting from the cancellation or change. Merchandise is not returnable unless written authorization is received from the factory. All transportation charges must be prepaid. Collect shipments will not be accepted. Return shipments, when accepted, are subject to a minimum 25% re-handling, re-stocking charge. No returns on modified or non-standard products will be allowed. Our agreement to accept a return is conditional upon our inspection of the returned products.

GOVERNING LAWS: The laws of the State of Ohio shall govern the agreement.

ALL PRICES AND PRODUCT SPECIFICATIONS ARE SUBJECT TO CHANGE WITHOUT NOTICE.

MAVERICK COLLECTION COLOR CARD

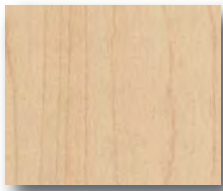

MAPLE

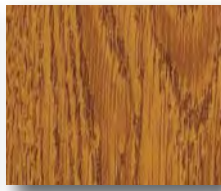

MEDIUM OAK

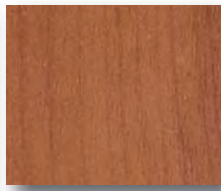

OILED CHERRY

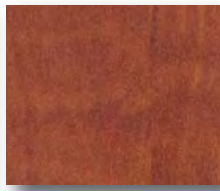

COGNAC

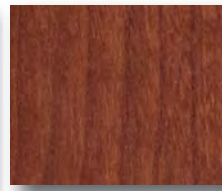

SEATTLE CHERRY



CHESTNUT

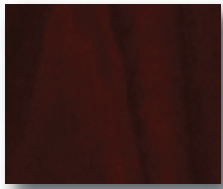

AFRICAN WALNUT

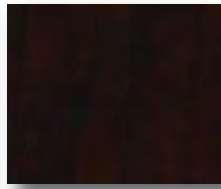

JAVA

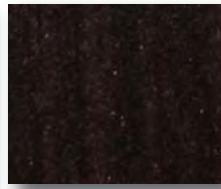

ESPRESSO

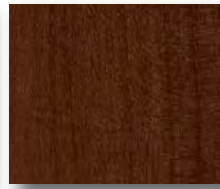

SPICE WALNUT

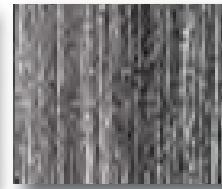

DRIFTWOOD

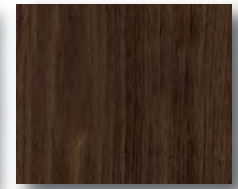

COLOMBIAN WALNUT

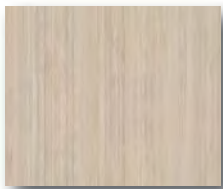

ASIAN SAND



GRAPHITE NEBULA



GREY



CHARCOAL

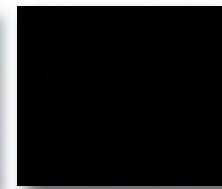

BLACK

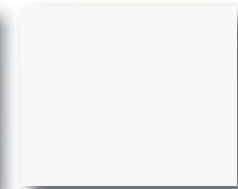

MAJESTIC WHITE

LAMINATE FINISHES AND FABRIC SAMPLES SHOWN ARE APPROXIMATIONS.
FOR ACTUAL LAMINATE SAMPLES, CONTACT MAVERICK DESK CUSTOMER SERVICE:
800.414.1655.

TACKBOARD FABRIC SAMPLES

FABRICS WITH * ARE 25% UPCHARGE



* COSMOPOLITAN 3097
IVORY 020



* COSMOPOLITAN 3097
CORNSILK 021



* COSMOPOLITAN 3097
EVERGLADE 010



* COSMOPOLITAN 3097
SHADOW 060



* COSMOPOLITAN 3097
EARTHEN 070



CAPE COD 3073
LINEN 7031



CAPE COD 3073
SURF 7062



TEMPEST 2120
SILK 045



TEMPEST 2120
ZEBRA 015



METRO 3077
SKYSCRAPER 022



METRO 3077
STOREFRONT 030



METALLATION 5118
CHROME 1676



METALLATION 5118
POLISHED PEWTER 1678



OTTO 2670
PLATINUM 7010



OTTO 2670
PEBBLE 7012



SPRITE 2671
SNOW 7040



SPRITE 2671
LINEN 7010



* UNDERGROUND 2967
CHAMPAGNE 010



* UNDERGROUND 2967
EARTH 061



* UNDERGROUND 2967
PEPPER 030



* UNDERGROUND 2967
OCEAN 041

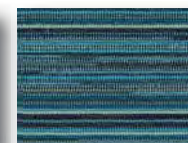

* UNDERGROUND 2967
AZURE 050



UNDERGROUND 2967
TANGERINE 070



ANCHORAGE 2335
SUNSHINE 2082



ANCHORAGE 2335
RED DELICIOUS 2014



ANCHORAGE 2335
AUBERGINE 2036



ANCHORAGE 2335
WATERFALL 2691

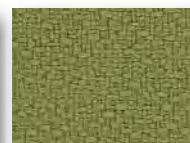

ANCHORAGE 2335
GREEN APPLE 2087



ANCHORAGE 2335
GOOSE 2049

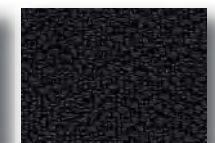



















ANCHORAGE 2335
ONYX 2016

MAVERICK

OFFICE SOLUTIONS | MADE IN THE U.S.A.

Finishes - Color Availability Chart

Color names	HPL Match	Maverick	Apex	Vista	Canyon
Woodgrains					
 Maple	Wilsonart 10776-60	•	•	•	•
 Medium Oak	Pionite W0291-S	•	•	•	•
 Oiled Cherry	Pionite WC421-S	•	•	•	•
 Cognac	Lamitech 1485	•	•	•	•
 Seattle Cherry	Lamitech 1820	•	•	•	•
 Chestnut	Proprietary	•	•	•	•
 African Walnut	Wilsonart 7122K-07	•	•	•	•
 Java	Proprietary	•	•	•	•
 Espresso	Proprietary	•	•	•	•
 Spice Walnut	Pionite WW011	•	•	•	•
 Driftwood	Pionite W150	•	•	•	•
 Colombian Walnut	Wilsonart 7943K-07	•	•	•	•
 Asian Sand	Wilsonart 7952K-07	•	•	•	•
Patterns					
 Graphite Nebula	Wilsonart 4623-60	•	•	•	•
Solids					
 Grey	Wilsonart D92-60	•	•	•	•
 Charcoal	Wilsonart S6054T	•	•	•	•
 Black	Nevamar S6053T	•	•	•	•
 Majestic White	Wilsonart 1573-60	•	•	•	•

• Indicates availability of color in series. A different chassis color may be selected from standard colors at no added cost.

3158 Production Drive
 Fairfield, Ohio 45014
 1-800-543-8249
 800-543-8221 fax
 maverickdesk.com

PRICE LIST
Effective
September 1, 2015